

## **GW5BTF50K00 LED for Lighting Applications**

### **Product Specification**

April 2010

“Miniature Zenigata” 6.7 W Module:  
High-output, 5000 K LED Module (410 lm)  
High Color Rendering (87 CRI)  
suited for lighting applications

Spec No.	DG-099011A
Issue	16-Apr-10

## S P E C I F I C A T I O N S

Product Type Light Emitting Diode Module

Model No. **GW5BTF50K00**

※These specifications contain 14 pages including the cover and appendix.  
If you have any objections, please contact us before issuing purchasing order.

### CUSTOMERS ACCEPTANCE

DATE: \_\_\_\_\_

BY: \_\_\_\_\_

PRESENTED

BY: \_\_\_\_\_

M.Katoh

Dept. General Manager

REVIEWED BY:

PREPARED BY:

\_\_\_\_\_

Development Department II  
System Device Division III  
Electronic Components And Devices Group  
SHARP CORPORATION

- Handle this document carefully for it contains material protected by international copyright law. Any reproduction, full or in part, of this material is prohibited without the express written permission of the company.
  
- When using the products covered herein, please observe the conditions written herein and the precautions outlined in the following paragraphs. In no event shall the company be liable for any damages resulting from failure to strictly adhere to these conditions and precautions.
  - (1) Please do verify the validity of this part after assembling it in customer's products, when customer wants to make catalogue and instruction manual based on the specification sheet of this part.
  
  - (2) The products covered herein are designed and manufactured for the following application areas. When using the products covered herein for the equipment listed in paragraph (3), even for the following application areas, be sure to observe the precautions given in Paragraph (3). Never use the products for the equipment listed in Paragraph (4).
    - Office electronics
    - Instrumentation and measuring equipment
    - Machine tools
    - Audiovisual equipment
    - Home appliances
    - Communication equipment other than for trunk lines
  
  - (3) These contemplating using the products covered herein for the following equipment which demands high reliability, should first contact a sales representative of the company and then accept responsibility for incorporating into the design fail-safe operation, redundancy, and other appropriate measures for ensuring reliability and safety of the equipment and the overall system.
    - Control and safety devices for airplanes, trains, automobiles, and other transportation equipment
    - Mainframe computers
    - traffic control systems
    - Gas leak detectors and automatic cutoff devices
    - Rescue and security equipment
    - Other safety devices and safety equipment, etc.
  
  - (4) Do not use the products covered herein for the following equipment which demands extremely high performance in terms of functionality, reliability, or accuracy.
    - Aerospace equipment
    - Communications equipment for trunk lines
    - Control equipment for the nuclear power industry
    - Medical equipment related to life support, etc.
  
  - (5) please direct all queries and comments regarding the interpretation of the above four Paragraphs to a sales representative of the company.
  
- Please direct all queries regarding the products covered herein to a sales representative of the company.

### GW5BTF50K00 specifications

#### 1. Application

These specifications apply to the light emitting diode module Model No. GW5BTF50K00.

[ High color rendering White (from InGaN Blue LED chip + Phosphor) LED module ]

Main application : Lighting

#### 2. External dimensions and equivalent circuit ----- Refer to Page 2.

#### 3. Ratings and characteristics ----- Refer to Page 3 - 5.

3-1. Absolute maximum ratings

3-2. Electro-optical characteristics

3-3. Derating curve

3-4. Characteristics diagram (TYP.)

#### 4. Reliability ----- Refer to Page 6.

4-1. Test items and test conditions

4-2. Failure criteria

#### 5. Quality level ----- Refer to Page 7.

5-1. Applied standard

5-2. Sampling inspection

5-3. Inspection items and defect criteria

#### 6. Supplements----- Refer to Page 8 - 9.

6-1. Chromaticity rank table

6-2. Packing

6-3. Label

6-4. Indication printed on product

#### 7. Precautions ----- Refer to Page 10 - 12.

2. External dimensions and equivalent circuit

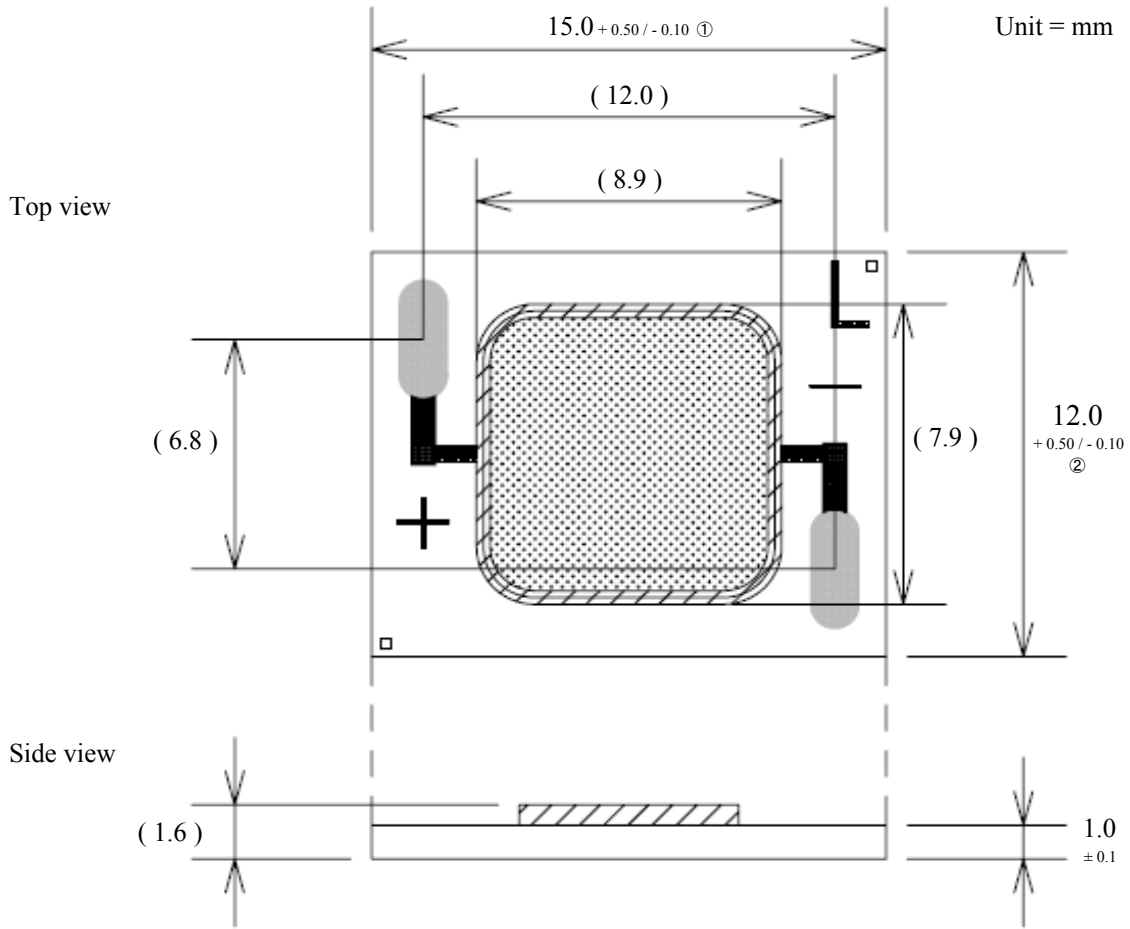

(Note) Values inside parentheses are reference values.  
External dimension of ceramic substrate is the indication of maximum length at each side.

Unit	Material	Drawing No.
mm	Substrate : Alumina Ceramic	52109007

### 3. Ratings and characteristics

#### 3-1. Absolute maximum ratings

Item	Symbol	Rating	Unit
Power Dissipation *1,4	P	8.0	W
Forward Current *1,4	I <sub>F</sub>	700	mA
Reverse Voltage *2,4	V <sub>R</sub>	-15	V
Operating Temperature *3	T <sub>opr</sub>	- 30 ~ + 90	°C
Storage Temperature	T <sub>stg</sub>	- 40 ~ + 100	°C

\*1 Power dissipation and forward current are the value when the module temperature is set lower than the rating by using an adequate heat sink.

\*2 Voltage resistible at initial connection error  
(Not dealing with the possibility of always-on reverse voltage.)

\*3 Case temperature T<sub>c</sub> (Refer to measuring point for case temperature in the next page.)  
Refer to "Derating curve" in the next page as for operating current.

\*4 T<sub>c</sub> = 25 °C

#### 3-2. Electro-optical characteristics

(T<sub>c</sub> = 25 °C)

Item	Symbol	Condition	MIN.	TYP.	MAX.	Unit
Forward Voltage *5	V <sub>F</sub>	I <sub>F</sub> = 640 mA	9.0	(10.2)	11.5	V
Luminous Flux *6	Φ	I <sub>F</sub> = 640 mA	330	(410)	-	lm
Chromaticity Coordinates *7	x	I <sub>F</sub> = 640 mA	-	(0.346)	-	-
	y		-	(0.360)	-	-
Color Temperature	-	I <sub>F</sub> = 640 mA	(4745)	(5000)	(5311)	K
General Color Rendering Index *8	Ra	I <sub>F</sub> = 640 mA	83	(87)	-	-

(Note) Values inside parentheses are shown for reference purpose only.

\*5 (After 20 ms drive, Measurement tolerance: ± 3 %)

\*6 Monitored by Sharp's 8 inch integrating sphere and Otsuka electronics MCPD-LE3400  
(After 20 ms drive, Measurement tolerance: ± 20 %)

\*7 Monitored by Sharp's 8 inch integrating sphere and Otsuka electronics MCPD-LE3400  
(After 20 ms drive, Measurement tolerance: ± 0.01)

\*8 Monitored by Sharp's 8 inch integrating sphere and Otsuka electronics MCPD-LE3400  
(After 20 ms drive, Measurement tolerance: ± 4)

3-3. Derating curve

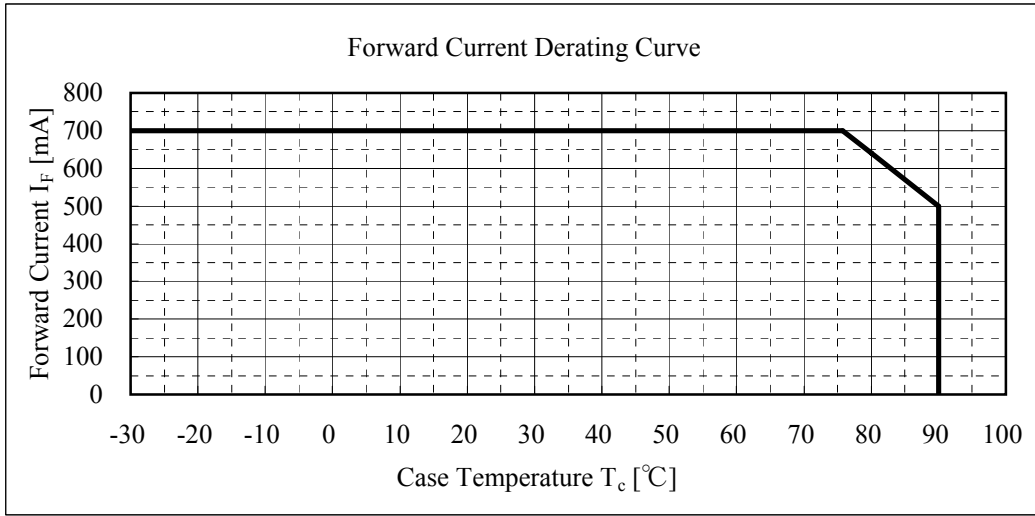

(Note) To keep the case temperature lower than the rating, enough heat-radiation performance needs to be secured by using an adequate heat sink.

(Measuring point for case temperature)

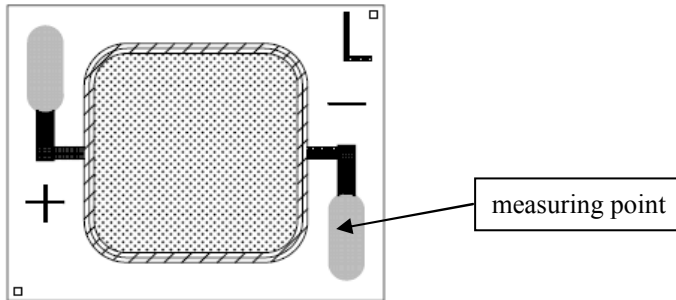

3-4. Characteristics diagram (TYP.)

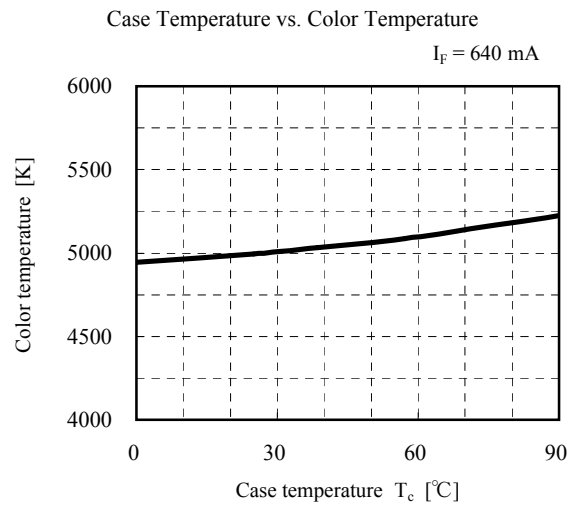
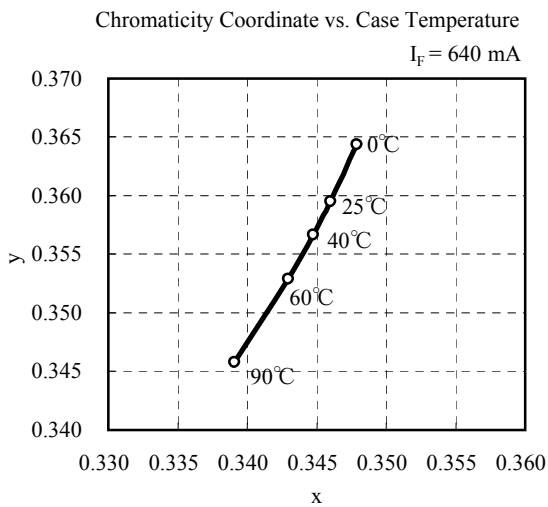
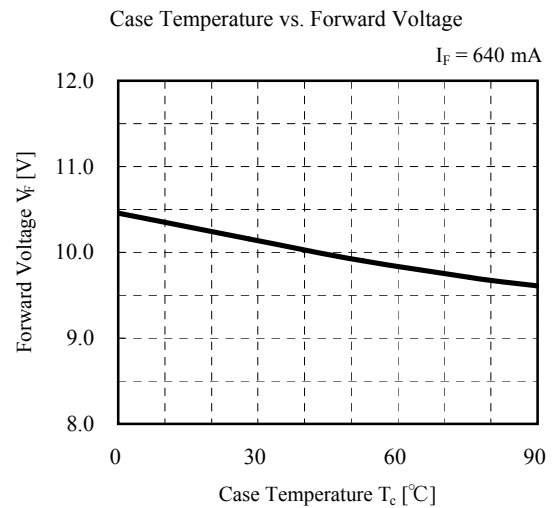
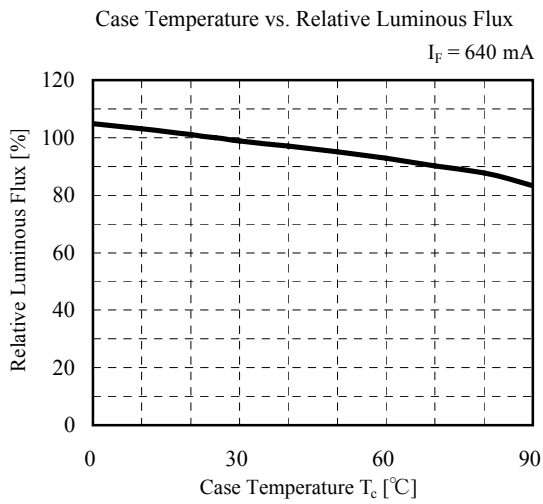
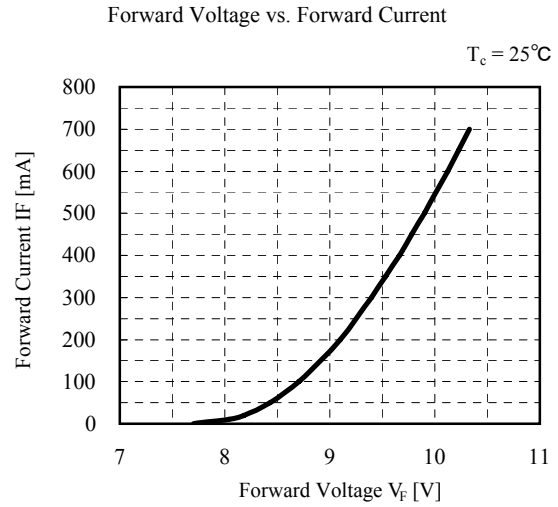
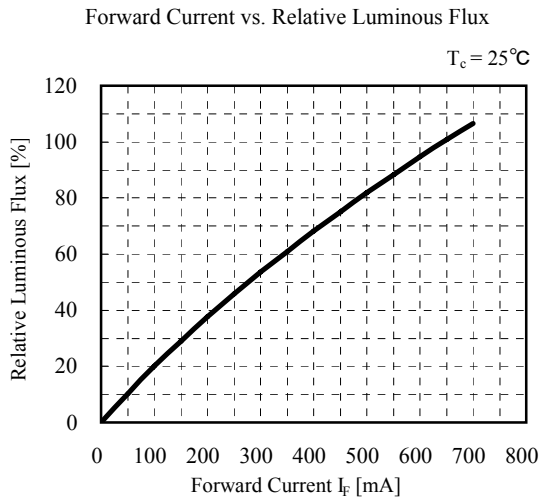

(Note) Characteristics data shown here are for reference purpose only. (Not guaranteed data)



4. Reliability

The reliability of products shall be satisfied with items listed below.

4-1. Test items and test conditions

Confidence level: 90 %

No.	Test item	Test conditions	Samples n	Defective C	LTPD (%)
1	Temperature Cycle	- 40 °C(30 min) ~ + 100 °C(30 min), 100 cycles	11	0	20
2	Temperature Humidity Storage	T <sub>stg</sub> = + 60 °C, RH = 90 %, Time = 1000 h	11	0	20
3	High Temperature Storage	T <sub>stg</sub> = + 100°C, Time = 1000 h	11	0	20
4	Low Temperature Storage	T <sub>stg</sub> = - 40 °C, Time = 1000 h	11	0	20
5	Steady State Operating Life	T <sub>c</sub> = 60 °C, I <sub>F</sub> = 700 mA, Time = 1000 h	11	0	20
6	Shock	Acceleration: 15000 m/s <sup>2</sup> , Pulse width: 0.5 ms Direction: 3 directions (X, Y and Z) 3 trials in each direction	5	0	50
7	Vibration	Frequency: 100 to 2000 Hz for 4 minutes per trial Acceleration: 200 m/s <sup>2</sup> Direction: 3 directions (X, Y and Z) 4 trials in each direction	5	0	50

4-2. Failure criteria

No.	Parameter	Symbol	Failure criteria
1	Forward Voltage	V <sub>F</sub>	V <sub>F</sub> > U.S.L × 1.1
2	Luminous Flux	Φ	Φ < Initial value × 0.7

(Note) U.S.L. stands for Upper Specification Limit.

5. Quality level

5-1. Applied standard  
ISO2859-1

5-2. Sampling inspection  
A single normal sampling plan, level S-4.

5-3. Inspection items and defect criteria

No.	Item	Defect criteria	Classification	AQL
1	No radiation	No light emitting	Major defect	0.1%
2	Electro-optical characteristics	Not conforming to the specification (Forward voltage, Luminous flux and Chromaticity)	Minor defect	0.4%
3	External dimensions	Not conforming to the specified dimensions (External dimensions of ① and ② shown in Page 2)		
4	Appearance	Nonconformity observed in product appearance is determined as defective only when electro-optical characteristics is affected by. <If any question arises regardless of above mentioned criterion> <ul style="list-style-type: none"> <li>■ Foreign material, scratch, or bubble at emitting area: 0.8 mm φ</li> <li>■ Fiber generation at emitting area: 0.2 mm in width and 2.5 mm in length</li> <li>■ Foreign material at connection terminal: 0.8 mm φ</li> <li>■ Substrate burr on edge: Over dimension tolerance</li> </ul>		

(Note) Products with removable foreign material attached on is not determined to be defective.

6. Supplements

6-1. Chromaticity rank table

(Tolerance:  $x, y \pm 0.01$ )

( $I_F = 640 \text{ mA}, T_c = 25 \text{ }^\circ\text{C}$ )

Range		Chromaticity coordinates			
		Point 1	Point 2	Point 3	Point 4
	x	0.3376	0.3369	0.3524	0.3551
	y	0.3616	0.3431	0.3555	0.3760

Rank		Chromaticity coordinates			
		Point 1	Point 2	Point 3	Point 4
1	x	0.3376	0.3369	0.3446	0.3464
	y	0.3616	0.3431	0.3493	0.3688
2	x	0.3464	0.3446	0.3524	0.3551
	y	0.3688	0.3493	0.3555	0.3760

Chromaticity Diagram

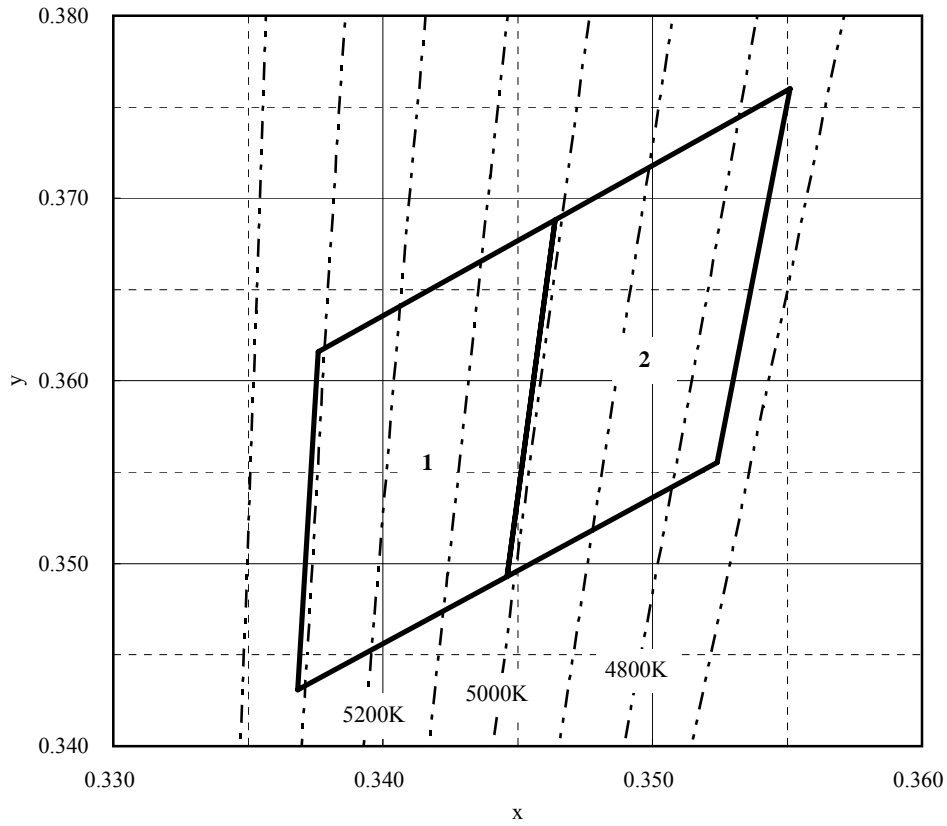

## 6-2. Packing

- One tray composed of 80 pieces
  - 5 trays (400 pieces) and one upper lid-tray in one moisture-proof bag
  - 2 bags (800 pieces) in one carton
  - Dimensions of outer carton: 235 × 220 × 90 mm (Reference value)
- (Note 1) There are cases of one carton composed of one bag. (400 pieces)  
 (Note 2) State of packing is subject to change.

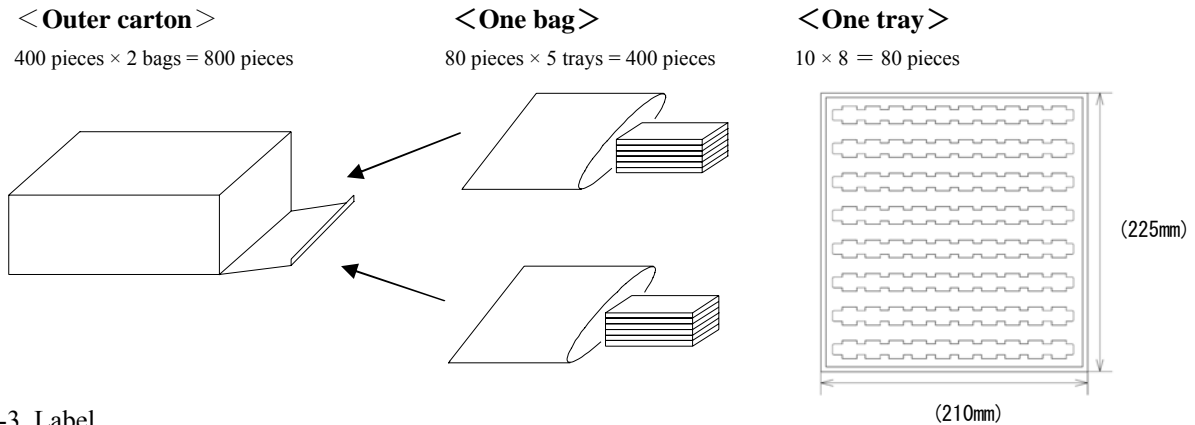

## 6-3. Label

Following label is attached on moisture-proof bags.



- ← Model number
- ← Quantity and rank
- ← Lot No.
- ← EIAJ C-3 Bar code
- ← Production country

### 1) Lot No. indication

5 0 0 3 G 0 1 0 0 1 A

①    ②   ③   ④    ⑤            ⑥    ⑦

- ① Production plant code
- ② Shipping year (Year last digit)
- ③ Shipping month (1~9 or O, N, D)
- ④ Fixed code G
- ⑤ Shipping date (01~31)
- ⑥ Serial No.
- ⑦ Fixed code A

## 6-4. Indication printed on product

Model No. and control No. are indicated on substrate surface.

### 1) Model No.

Abbreviated Model No. "5BTF50K00" is indicated.

### 2) Control No.

Indicated as follows;

M 1 0 C 0 1 - 1

①    ②    ③    ④    ⑤

- ① Production plant code (to be indicated alphabetically)
- ② Year of production (the last two figures of the year)
- ③ Month of production  
(to be indicated alphabetically with January corresponding to A)
- ④ Date of production (01~31)
- ⑤ Rank: Chromaticity rank is indicated as follows;  
Rank 1 → 1

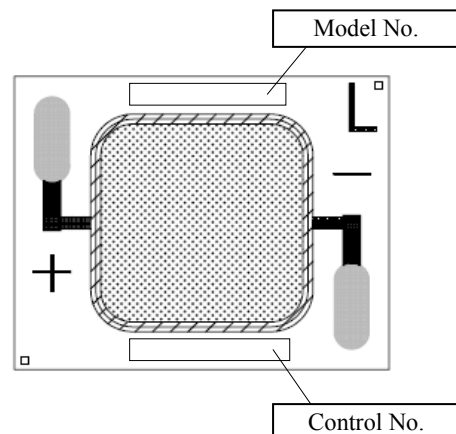

## 7. Precautions

### ① Storage conditions

Please follow the conditions below.

- Before opened: Temperature 5 ~ 30 °C, Relative humidity less than 60 %.  
(Before opened LED should be used within a year)
- After opened: Temperature 5 ~ 30 °C, Relative humidity less than 60 %.  
(Please apply soldering within 1 week)
- After opened LED should be kept in an aluminum moisture proof bag with a moisture absorbent material (silica gel).
- Avoid exposing to air with corrosive gas.  
If exposed, electrode surface would be damaged, which may affect soldering.

### ② Usage conditions

This product is not designed for the use under any of the following conditions.

Please confirm performance and reliability well enough if you use under any of the following conditions;

- In a place with a lot of moisture, dew condensation, briny air, and corrosive gas.  
(Cl, H<sub>2</sub>S, NH<sub>3</sub>, SO<sub>2</sub>, NO<sub>x</sub>, etc.)
- Under the direct sunlight, outdoor exposure, and in a dusty place.
- In water, oil, medical fluid, and organic solvent.

### ③ Heat radiation

If forward current ( $I_F$ ) is applied to single-state module at any current, there is a risk of damaging LED or emitting smoke.

Equip with specified heat radiator, and avoid heat stuffed inside the module.

### ④ Installation

Material of board is alumina ceramic. If installed inappropriately, trouble of no radiation may occur due to board crack or overheat. Please take particular notice for installation.

Refer to the following cautions on installation.

- Apply thermolysis adhesive, adhesive sheet or peculiar connector when mounted on heat radiator.  
In case of applying adhesive or adhesive sheet only, check the effectiveness and reliability before fixing.  
If LED comes off from heat radiator, unusual temperature rise entails hazardous phenomena including device deterioration, coming off of solder at leads, and emitting smoke.
- When LED device is mechanically fixed or locked, Please take into consideration regarding the method of attachment due to fail from stress.
- Avoid convexly uneven boards.  
Convex board is subject to substrate cracking or debasement of heat release.
- It is recommended to apply adhesive or adhesive sheet with high thermal conductivity for radiation of heat effectively.
- Please take care about the influence of color change of adhesive or adhesive sheet in initial and long term period, which may affect light output or color due to change of reflectance from backside.

- Do not touch resin part including white resin part on the surface of LED.  
No light emission may occur due to damage of resin or cutting wire of LEDs by outer force.  
When using tweezers, please handle by ceramic substrate part and avoid touching resin part.  
For mounting, please handle by side part of ceramic or the specified area shown below.

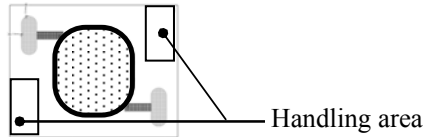

#### ⑤ Connecting method

In case of solder connecting method, follow the conditions mentioned below.

- Use Soldering iron with thermo controller (tip temperature 380 °C), within 5 seconds per one place.
- Secure the solderwettability on whole solder pad and leads.
- During the soldering process, put the ceramic board on materials whose conductivity is poor enough not to radiate heat of soldering.
- Warm up (with using a heated plate) the substrate is recommended before soldering.  
( preheat condition: 100 °C ~ 150 °C, within 60 sec )
- Avoid touching a part of resin with soldering iron.
- This product is not designed for reflow and flow soldering.
- Avoid such lead arrangement as applying stress to solder-applied area.
- Please do not detach solder and make re-solder.
- Please solder evenly on each electrodes.
- Please prevent flux from touching to resin.

#### ⑥ Static electricity

This product is subject to static electricity, so take measures to cope with it.  
Install circuit protection device to drive circuit, if necessary.

#### ⑦ Drive method

- Any reverse voltage cannot be applied to LEDs when they are in operation or not.  
Design a circuit so that any flow of reverse or forward voltage can not be applied to LEDs when they are out of operation.
- Module is composed of LEDs connected in both series and parallel.  
Constant voltage power supply runs off more than specified current amount due to lowered  $V_F$  caused by temperature rise.  
Constant current power supply is recommended to drive.

#### ⑧ Cleaning

Avoid cleaning, since silicone resin is eroded by cleaning.

#### ⑨ Color-tone variation

Chromaticity of this product is monitored by integrating sphere right after the operation.  
Chromaticity varies depending on measuring method, light spread condition, or ambient temperature.  
Please verify your actual conditions before use.

Model No. <b>GW5BTF50K00</b>	Page 12 of 12
---------------------------------	------------------

**⑩ Safety**

- Looking directly at LEDs for a long time may result in hurt your eyes.
- In case that excess current (over ratings) are supplied to the device, hazardous phenomena including abnormal heat generation, emitting smoke, or catching fire can be caused.  
Take appropriate measures to excess current and voltage.
- In case of solder connecting method, there is a possibility of fatigue failure by heat.  
Please fix the leads in such case to protect from short circuit or leakage of electricity caused by contact.
- Please confirm the safety standards or regulations of application devices.
- Please careful not to injure your hand by edge of ceramic substrate.

**⑪ Other cautions**

Guarantee covers the compliance to the quality standards mentioned in the Specifications, however it does not cover the compatibility with application of the end-use, including assembly and usage environment.

In case any quality problems occurred in the application of end-use, details will be separately discussed and determined between the parties hereto.

# Opto Specification

## Opto/EC Group



### NORTH AMERICA

Sharp Microelectronics of the Americas  
5700 NW Pacific Rim Blvd.  
Camas, WA 98607, U.S.A.  
Phone: (1) 360-834-8700  
Fax: (1) 360-834-8903  
www.sharpsma.com

### TAIWAN

Sharp Electronic Components  
(Taiwan) Corporation  
8F-A, No. 16, Sec. 4, Nanking E. Rd.  
Taipei, Taiwan, Republic of China  
Phone: (886) 2-2577-7341  
Fax: (886) 2-2577-7326/2-2577-7328

### CHINA

Sharp Microelectronics of China  
(Shanghai) Co., Ltd.  
28 Xin Jin Qiao Road King Tower 16F  
Pudong Shanghai, 201206 P.R. China  
Phone: (86) 21-5854-7710/21-5834-6056  
Fax: (86) 21-5854-4340/21-5834-6057  
Head Office:  
No. 360, Bashen Road,  
Xin Development Bldg. 22  
Waigaoqiao Free Trade Zone Shanghai  
200131 P.R. China  
Email: smc@china.global.sharp.co.jp

### EUROPE

Sharp Microelectronics Europe  
Division of Sharp Electronics (Europe) GmbH  
Sonninstrasse 3  
20097 Hamburg, Germany  
Phone: 49 (0)180 507 35 07  
Fax: (49) 40-2376-2232  
www.sharpsme.com

### SINGAPORE

Sharp Electronics (Singapore) PTE., Ltd.  
438A, Alexandra Road, #05-01/02  
Alexandra Technopark,  
Singapore 119967  
Phone: (65) 271-3566  
Fax: (65) 271-3855

### KOREA

Sharp Electronic Components  
(Korea) Corporation  
RM 501 Geosung B/D, 541  
Dohwa-dong, Mapo-ku  
Seoul 121-701, Korea  
Phone: (82) 2-711-5813 ~ 8  
Fax: (82) 2-711-5819

### JAPAN

Sharp Corporation  
Electronic Components & Devices  
22-22 Nagaïke-cho, Abeno-Ku  
Osaka 545-8522, Japan  
Phone: (81) 6-6621-1221  
Fax: (81) 6117-725300/6117-725301  
www.sharp-world.com

### HONG KONG

Sharp-Roxy (Hong Kong) Ltd.  
Level 26, Tower 1, Kowloon Commerce Centre,  
No. 51, Kwai Cheong Road, Kwai Chung,  
New Territories, Hong Kong  
Phone: (852) 28229311  
Fax: (852) 28660779  
www.sharp.com.hk  
Shenzhen Representative Office:  
Room 602-603, 6/F,  
International Chamber of Commerce Tower,  
168 Fuhua Rd. 3, CBD,  
Futian District, Shenzhen 518048,  
Guangdong, P.R. China  
Phone: (86) 755-88313505  
Fax: (86) 755-88313515

SPECIFICATIONS ARE SUBJECT TO CHANGE WITHOUT NOTICE.

Suggested applications (if any) are for standard use; See Important Restrictions for limitations on special applications. See Limited Warranty for SHARP's product warranty.

The Limited Warranty is in lieu, and exclusive of, all other warranties, express or implied.

ALL EXPRESS AND IMPLIED WARRANTIES, INCLUDING THE WARRANTIES OF MERCHANTABILITY, FITNESS FOR USE AND FITNESS FOR A PARTICULAR PURPOSE, ARE SPECIFICALLY EXCLUDED. In no event will SHARP be liable, or responsible in any way, for any incidental or consequential economic or property damage.