

771

Milliamp Process Clamp Meter

Instruction Sheet

Introduction

The Fluke 771 Milliamp Process Clamp Meter (“the Meter”) is a hand-held battery-operated clamp meter that measures 4-20 mA dc without breaking the electrical circuit. Unlike conventional clamp meters, the Meter features a remote jaw that is connected to the main body via extension cable.

Features

- DC mA measurement (4-20 mA) using a remotely connected clamp via extension cable
- Electronic zero
- Percentage span (0-100 %)
- Hold
- Display backlight
- Auto power off
- Measurement spotlight LED

The Meter comes with:

- Two AA alkaline batteries (installed)
- Soft case
- Instruction sheet

PN 2567301

September 2006

© 2006 Fluke Corporation. All rights reserved. Printed in China.

All product names are trademarks of their respective companies

Contacting Fluke

To contact Fluke, use one of the following telephone numbers:

USA: 1-888-99-FLUKE (1-888-993-5853)

Canada: 1-800-36-FLUKE (1-800-363-5853)

Europe: +31 402-675-200

Japan: +81-3-3434-0181

Singapore: +65-738-5655

Anywhere in the world: +1-425-446-5500

Or visit Fluke's Web site at: www.fluke.com.

Register the Meter at: <http://register.fluke.com>

Safety Information and Symbols

A “ **Warning**” statement identifies hazardous conditions and actions that could cause bodily harm or death.

A “ **Caution**” statement identifies conditions and actions that could damage the Meter or the equipment under test.

Read First: Safety Information

To ensure safe operation and service of the Meter, follow these instructions:

- Read the *Instruction Sheet* before use and follow all safety instructions.
- Use the Meter only as specified in the *Instruction Sheet*; otherwise, the Meter's safety features may be impaired.
- Before each use inspect meter and cable for damage. Look for cracks and missing portions of the clamp and cable. Do not use if clamp is damaged.
- Use caution when working with voltages above 33 V rms 47 V peak or 70 V dc these voltages pose a shock hazard.
- Do not use to measure ac current.
- Do not use to measure dc mA in circuits carrying more than 300 V CAT II.
- Avoid working alone so assistance can be rendered in an emergency.











- Use extreme caution when working around bare conductors or bus bars. Contact with the conductor could result in electric shock.
- To avoid false readings that can lead to electrical shock and injury, replace the batteries as soon as the low battery indicator  appears.
- Adhere to local and national safety codes. Individual protective equipment must be used to prevent shock and arc blast injury where hazardous live conductors are exposed.
- When measuring, keep fingers behind the Tactile Barrier.
- Not to be used on non-insulated conductors.

Table 1 explains the symbols that are used on the Meter or in this instruction sheet.

Table 1. Symbols

	Do not apply around, or remove from HAZARDOUS LIVE conductors
	Risk of danger. Important information. See Users Manual.
	Risk of Electrical Shock
	Equipment protected by double or reinforced insulation
	Battery
	Conforms to relevant European Union directives
	DC (Direct Current)
	Do not dispose of this product as unsorted municipal waste. Contact Fluke or a qualified recycler for disposal.
 N10140	Conforms to relevant Australian standards
	Conforms to relevant Canadian and US standards
CAT II 300 V	Equipment is designed to protect against transients in equipment in fixed-equipment installations, such as distribution panels, feeders and short branch circuits, and lighting systems in large buildings.

Getting Acquainted with the Meter

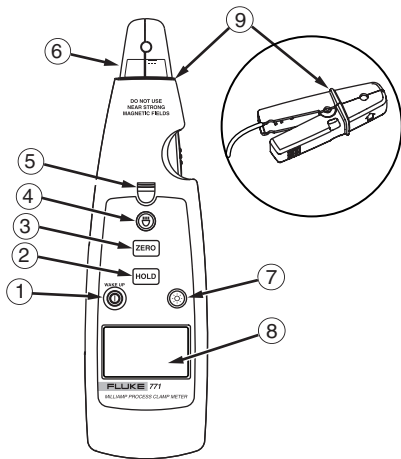

ege01a.eps

Number	Description
①	Turns the Meter on and off. When the Meter is in sleep mode, press this button to wake it up.
②	Captures and holds the current reading
③	Removes interference and zeros the display
④	Measurement spotlight LED button
⑤	Measurement spotlight LED
⑥	Detachable clamp
⑦	Turns the backlight off and on
⑧	LCD
⑨	Tactile Barrier docked and un-docked

Figure 1. The 771 Milliamper Process Clamp Meter

Features

The following sections give more detail about the Meter's features.

Percentage Span

The Percentage Span feature displays the span for 4 to 20 mA loops.

20 mA	100 %	4 mA	0 %
16 mA	75 %	3.6 mA	-2.5 %
12 mA	50 %	3.2 mA	-5.0 %
8 mA	25 %	2 mA	-12.5 %

Zero Adjust



Before taking each measurement, push **ZERO** to zero the display by removing dc offset. Make sure the clamp jaws are closed and no current is flowing through them.

Backlight

Press  to turn the backlight on and off. The backlight automatically turns off after 2 minutes.

To disable the automatic 2-minute backlight timeout, hold down  while turning the Meter on.



Measurement Spotlight LED

The Measurement Spotlight LED helps to quickly find mA signal wires. To activate it, press . To extend battery life, the light automatically turns off after 2 minutes. To disable the automatic timeout, hold down  while turning the Meter on.



Display HOLD

Warning

To avoid electric shock, when Display HOLD is activated, the display will not change when a different current is applied.

Pressing  activates Display Hold mode. **HOLD** is displayed and the Meter freezes the display. To exit and return to normal operation, press  a second time.

Auto Off

The Meter automatically turns off after 15 minutes of inactivity. To disable the Auto Off feature, hold down  while turning on the Meter. If the Meter has automatically shut down, restart it by pushing  (“WAKE UP”).

Taking Measurements

Warning

The Clamp Meter is not for use on non-insulated conductors.

Measurements can be taken with the clamp in the docked position, or remotely via the 1 m cable. For accurate measurements:

- Always zero the Meter prior to taking measurements.
- Zero the Meter as close to the measurement source as possible.
- Make sure the clamp is free of contamination.

Note

To reduce magnetic influences, zero the Meter in the same position or jaw direction that is used for the measurements.

1. With the clamp disconnected from any conductor, press ① to turn the Meter on and press **ZERO**.
2. Clamp the jaw around the conductor under test. The Meter displays the measured conductor current. See Figure 2.
 - A positive reading indicates current flowing in the direction of the arrow on the clamp.
 - A negative reading indicates current flowing in the opposite direction of the arrow.
 - Do not clamp more than one wire. Currents cancel and no results are returned.

The small secondary display shows the reading in terms of percentage span.

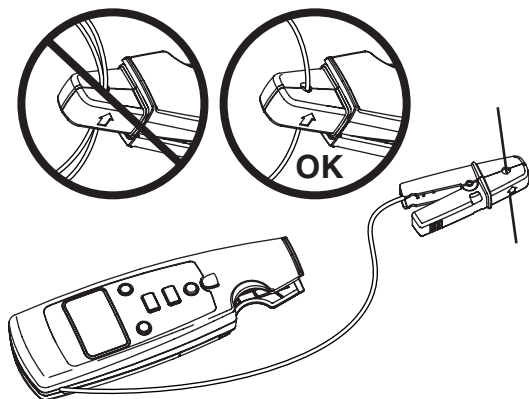

ege03.eps

Figure 2. Taking Measurements

Maintenance

⚠ ⚠ Warning

To avoid possible electric shock or personal injury, repairs or servicing not covered in this manual should be performed only by qualified personnel.

Cleaning the Meter

⚠ ⚠ Warning

To avoid electrical shock, remove any input signals before cleaning.

⚠ Caution

To avoid damaging the Meter, do not use aromatic hydrocarbons or chlorinated solvents for cleaning. These solutions will react with the plastics used in the Meter.

Clean the instrument case with a damp cloth and mild detergent.

Battery Replacement

⚠ ⚠ Warning

To avoid false readings, that could lead to possible electric shock or personal injury, replace the battery as soon as the low battery indicator (🔋) appears.

To replace the battery (see Figure 3):

1. Turn the Meter off.
2. Use a flat head screwdriver to loosen the battery compartment door screw, and remove the door from the case bottom.
3. Remove the battery.
4. Replace the battery with two new AA batteries.
5. Reattach the battery compartment door to the case bottom and tighten the screw.

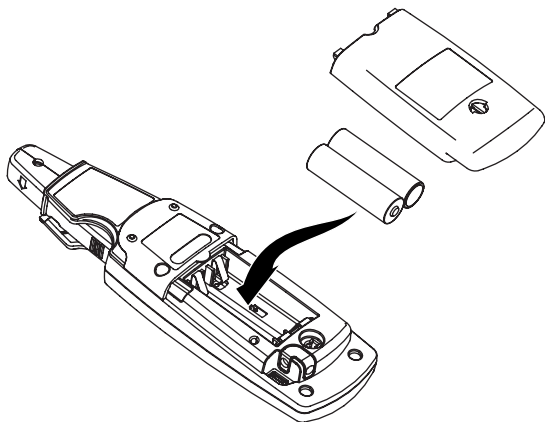





Figure 3. Changing the Batteries

Specifications

Current Ranges	±20.99 mA	±21.0 mA -±99.9 mA
Resolution	0.01 mA	0.1 mA
Accuracy		
20.99 mA range	0.2 % reading ±5 digits	
99.9 mA range	1 % reading ±5 digits	
Maximum Reading	±99.9 mA	
Influence of Earth's Field	< 0.20 mA	
Battery	2 AA 1.5 V Alkaline, IEC LR6	
Working hours	45 hours	
Size (H X W X L)	59 mm x 38 mm x 212 mm (with clamp nested)	
Weight	260g (Including battery)	
Operating Temperature	-10 to 50 °C	
Storage Temperature	-25 to 70 °C	
Operating Humidity	< 90 % @ <30 °C, <75 % @ 30 to 50 °C	
Operating Altitude	0 to 2000 m	
Storage Altitude	None	
IP Rating	IP 40	
Vibration Requirements	Random 2 g, 5 to 500 Hz	
EMI, RFI, EMC	Meets all applicable requirements in EN 61326-1	
Temperature Coefficients	0.1x(specified accuracy)/°C (< 18 °C or > 28 °C)	
Measurement Category	IEC 61010-1 61010-2-032 CAT II 300 V CAT II Equipment is designed to protect against transients from energy- consuming equipment supplied from the fixed installation, such as TVs, PCs, portable tools, and other household appliances.	
Agency Approvals	   , FCC	

N10140

User Replaceable Parts

Table 2 lists all user replaceable parts.

Table 2. Replaceable Parts

Part or Model Number	Description	Quantity
376756	AA Batteries, 1.5 V	2
2687457	Absorber	1
2720304	Battery door	1
948609	Fastener	1
2726174	Soft Carrying Case	1
2567301	Instruction Sheet	1
2742724	Service Information Sheet	1
Replacement clamp and cable assembly are available but require recalibration. See the <i>771 Service Information Sheet</i> for part numbers and procedures.		

LIMITED WARRANTY & LIMITATION OF LIABILITY

This Fluke product will be free from defects in material and workmanship for 3 years (one year for cable and clamp) from the date of purchase. This warranty does not cover fuses, disposable batteries or damage from accident, neglect, misuse or abnormal conditions of operation or handling. Resellers are not authorized to extend any other warranty on Fluke's behalf. To obtain service during the warranty period, send your defective Meter to the nearest Fluke Authorized Service Center with a description of the problem.

THIS WARRANTY IS YOUR ONLY REMEDY. NO OTHER WARRANTIES, SUCH AS FITNESS FOR A PARTICULAR PURPOSE, ARE EXPRESSED OR IMPLIED. FLUKE IS NOT LIABLE FOR ANY SPECIAL, INDIRECT, INCIDENTAL OR CONSEQUENTIAL DAMAGES OR LOSSES, ARISING FROM ANY CAUSE OR THEORY. Since some states or countries do not allow the exclusion or limitation of an implied warranty or of incidental or consequential damages, this limitation of liability may not apply to you.