

CARMEN-50-S-C

~24° spot beam. Assembly with holder C compatible with LEDiL HEKLA.

TECHNICAL SPECIFICATIONS:

Dimensions	Ø 50.0 mm
Height	25.5 mm
Fastening	socket
Colour	black
Box size	476 x 273 x 292 mm
Box weight	6.9 kg
Quantity in Box	308 pcs
ROHS compliant	yes ⓘ



MATERIAL SPECIFICATIONS:

Component	Type	Material	Colour
CARMEN-50-S	Lens	PMMA	clear
CARMEN-50-HLD-C	Holder	PC	black

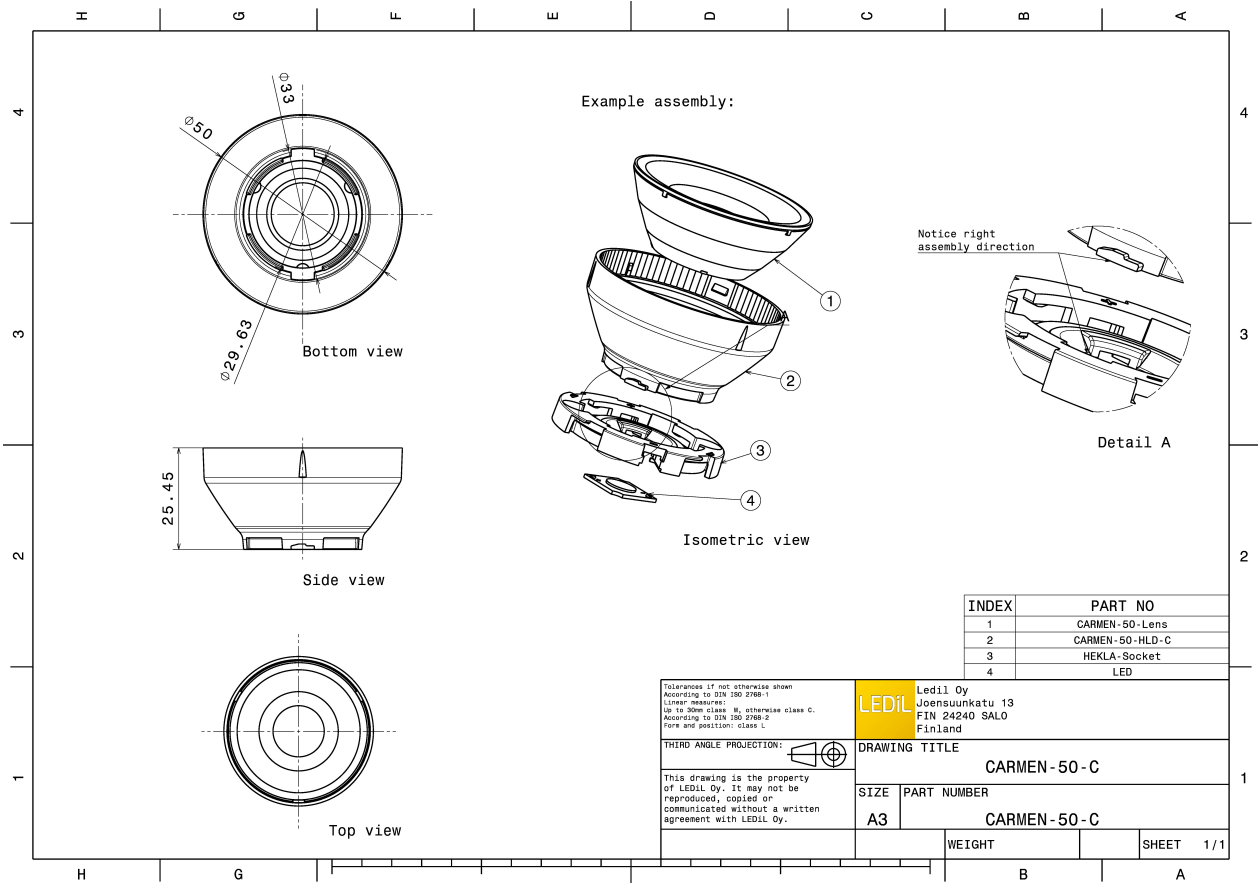

PHOTOMETRIC DATA (MEASURED):

CITIZEN

LED CLL02x/CLU02x (LES10)
 FWHM 24.0°
 Efficiency 66 %
 Peak intensity 3.100 cd/lm
 Required components:
 F15255_HEKLA-SOCKET-C

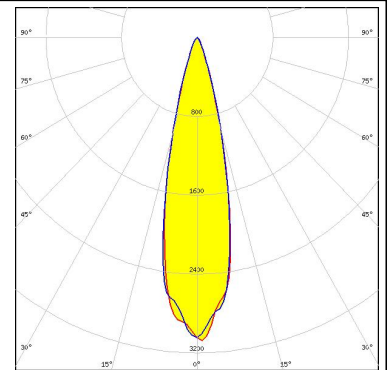
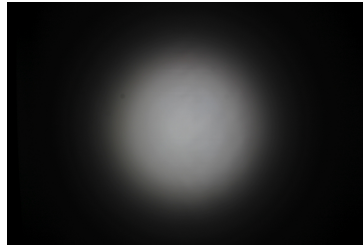

CITIZEN

LED CLU700/701
 FWHM 19.0°
 Efficiency 73 %
 Peak intensity 5.300 cd/lm
 Required components:
 F15255_HEKLA-SOCKET-C

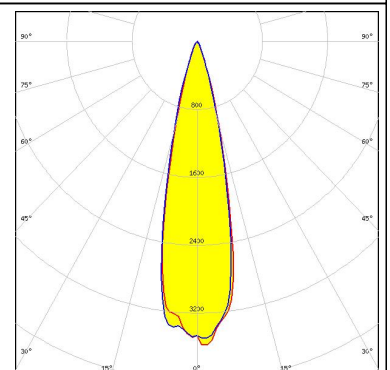
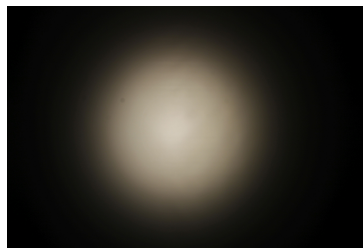

CREE

LED CMA1516
 FWHM 25.0°
 Efficiency 68 %
 Peak intensity 3.000 cd/lm
 Required components:
 F15256_HEKLA-SOCKET-D

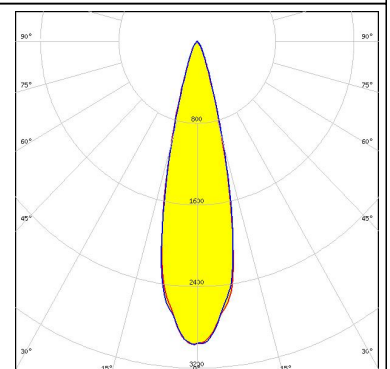
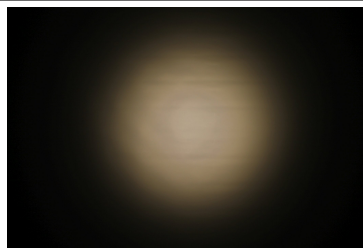

CREE

LED CXA/B 13xx
 FWHM 22.0°
 Efficiency 77 %
 Peak intensity 4.500 cd/lm
 Required components:
 F15956_HEKLA-SOCKET-J

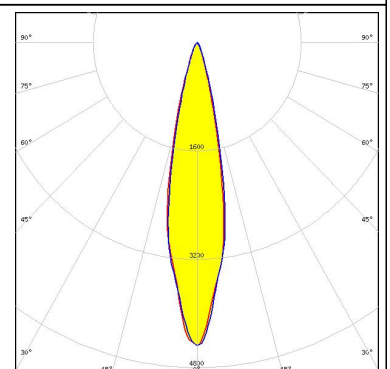
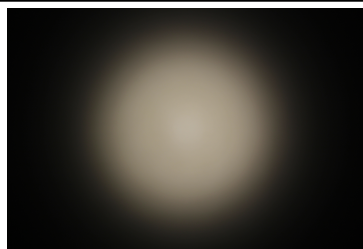

PHOTOMETRIC DATA (MEASURED):



LED CXA/B 13xx
 FWHM 21.0°
 Efficiency 76 %
 Peak intensity 4.500 cd/lm
 Required components:
 F15956_HEKLA-SOCKET-J

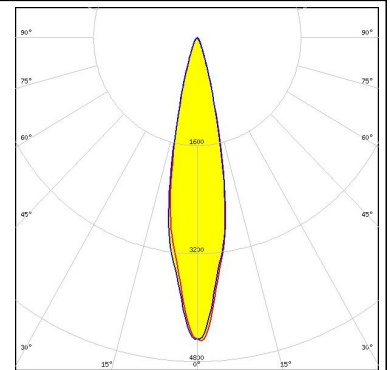

LED CXA/B 15xx
 FWHM 24.0°
 Efficiency 69 %
 Peak intensity 3.400 cd/lm
 Required components:
 F15256_HEKLA-SOCKET-D

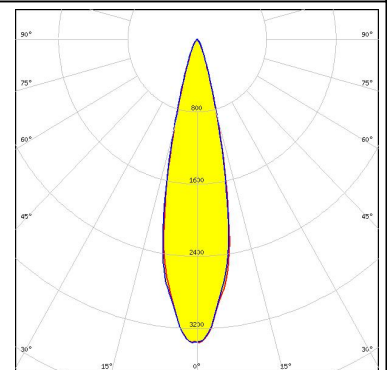
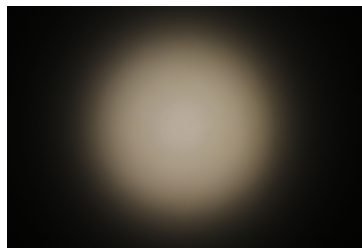

LED LUXEON CoB 1202s
 FWHM 21.0°
 Efficiency 75 %
 Peak intensity 4.700 cd/lm
 Required components:
 F15848_HEKLA-SOCKET-G

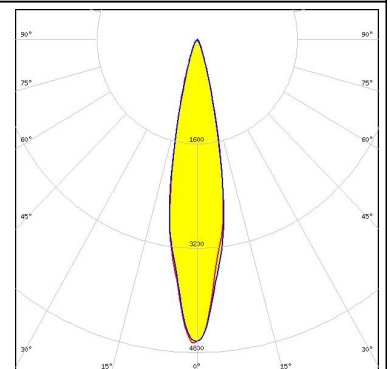
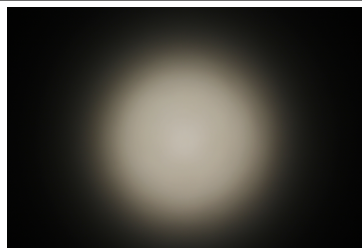

LED CDM-9 (Dim-To-Warm)
 FWHM 21.0°
 Efficiency 57 %
 Peak intensity 3.700 cd/lm
 Required components:
 C16142_HEKLA-SOCKET-K
 Bender Wirth: 490 Typ L8

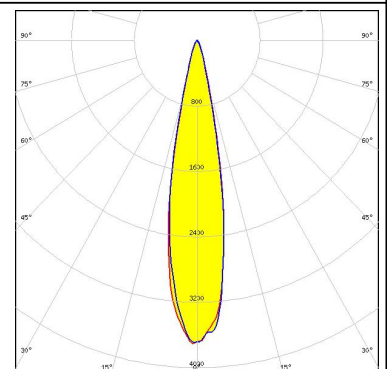
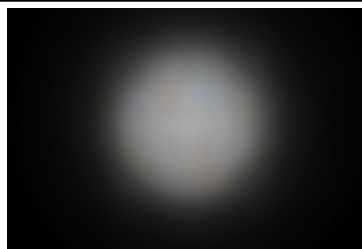

PHOTOMETRIC DATA (MEASURED):



LED CXM-9
 FWHM 24.0°
 Efficiency 67 %
 Peak intensity 3.100 cd/lm
 Required components:
 F15255_HEKLA-SOCKET-C

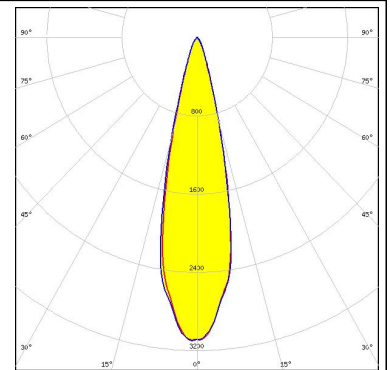
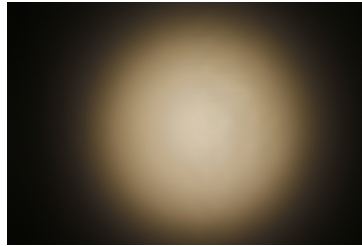

LED COB S-Type (LES 7)
 FWHM 22.0°
 Efficiency 73 %
 Peak intensity 4.100 cd/lm
 Required components:
 F15848_HEKLA-SOCKET-G

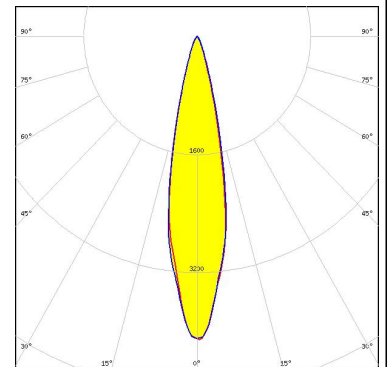

LED COB D Series LES 9.8 mm
 FWHM 25.0°
 Efficiency 67 %
 Peak intensity 3.000 cd/lm
 Required components:
 F15255_HEKLA-SOCKET-C

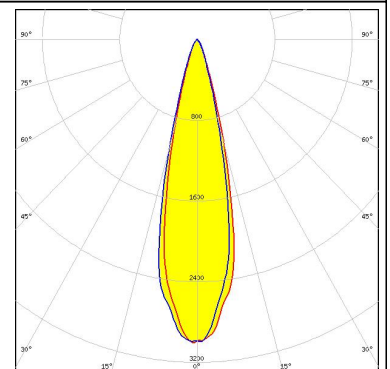
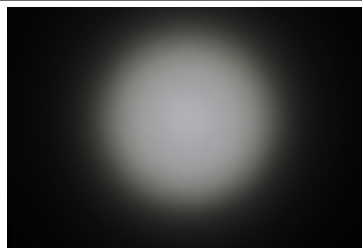

LED LC010C G2
 FWHM 19.0°
 Efficiency 74 %
 Peak intensity 5.300 cd/lm
 Required components:
 F15255_HEKLA-SOCKET-C

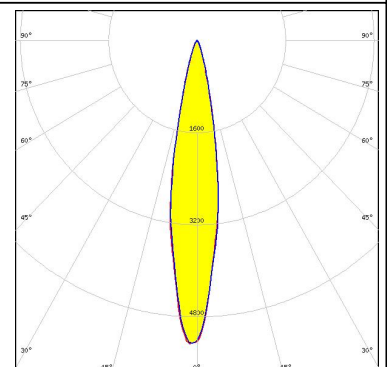

PHOTOMETRIC DATA (SIMULATED):

bridgelux.

LED V6 Gen6
FWHM 21.0°
Efficiency 71 %
Peak intensity 4.400 cd/lm
Required components:
F15253_HEKLA-SOCKET-A

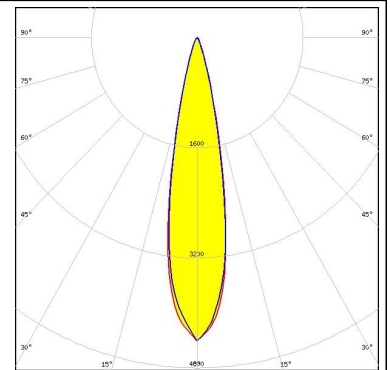

bridgelux.

LED VERO10
FWHM 24.0°
Efficiency 64 %
Peak intensity 3.180 cd/lm
Required components:
F15616_HEKLA-SOCKET-F

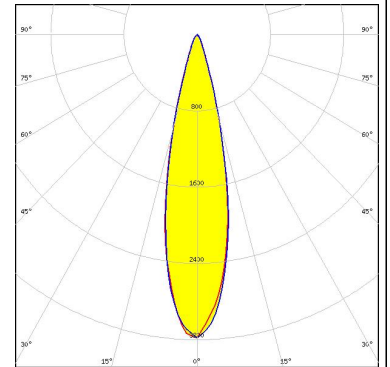

bridgelux.

LED VERO13
FWHM 27.0°
Efficiency 66 %
Peak intensity 2.500 cd/lm
Required components:
C16142_HEKLA-SOCKET-K

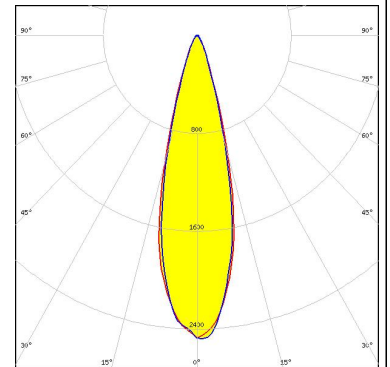

TRIDONIC

LED SLE G5 LES11
FWHM 24.0°
Efficiency 63 %
Peak intensity 3.000 cd/lm
Required components:
F15255_HEKLA-SOCKET-C

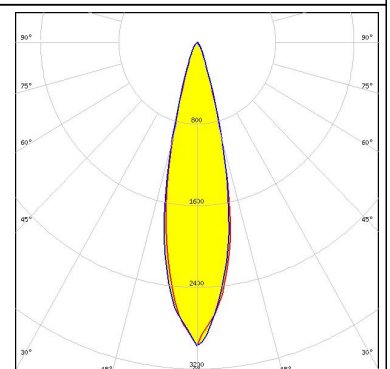

PHOTOMETRIC DATA (SIMULATED):

XICATO

LED XTM - 9mm LES
FWHM 25.0°
Efficiency 67 %
Peak intensity 3.000 cd/lm
Required components:
C15743_XTM-ADAPTER-50-B

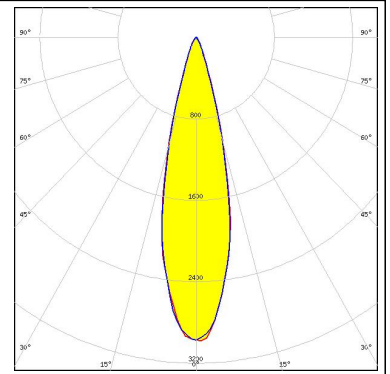

GENERAL INFORMATION:

NOTE: The typical beam angle will be changed by different color, chip size and chip position tolerance. The typical total beam angle is the full angle measured where the luminous intensity is half of the peak value.

Due to use of high power COB's with this product, special attention to proper thermal design is highly recommended. LEDiL has no liability for direct, indirect or consecutive damages arising from the LEDiL products being used outside of the recommended temperature range.

MATERIALS:

As part of our continuous research and improvement processes, and to ensure the best possible quality and availability of our products, LEDiL reserves the right to change material grades without notice.

PRODUCT DATA USER AGREEMENT AND DISCLAIMER:

The measured data in the provided downloadable LEDiL Product Datasheets and Mechanical 2D-Drawings is rounded and provided as reference for planning. LEDiL Oy's optical specifications have been verified by conducting performance testing of the products in accordance with the company's quality system. The reported data are averaged results of multiple measurements with typical variation. LEDiL Oy reserves the right to without prior notification make changes and improvements to its products.

LEDiL Oy assumes neither warranty, nor guarantee nor any other liability of any kind for the contents and correctness of the provided data. The provided data has been generated with highest diligence but the provided data may in reality not represent the complete possible variation range of all intrinsic parameters. Therefore, in certain cases a deviation from the provided data could occur.

LEDiL Oy reserves the right to undertake technical changes of its products without further notification which could lead to changes in the provided data. LEDiL Oy assumes no liability of any kind for the possible deviation from any provided data or any other damage resulting from the usage of the provided data.

The user agrees to this disclaimer and user agreement with the download or usage of the provided files.

LEDiL Oy

Joensuunkatu 13
FI-24240 SALO
Finland

LEDiL Inc.

228 West Page Street
Suite D
Sycamore IL 60178
USA

Local sales and technical support

[www.ledil.com/
where_to_buy](http://www.ledil.com/where_to_buy)

Shipping locations

Salo, Finland
Hong Kong, China

Distribution Partners

[www.ledil.com/
where_to_buy](http://www.ledil.com/where_to_buy)