

GENERAL DESCRIPTION

The M665 is a dual SAW, selectable frequency VCSO frequency source for low-jitter clock generation. An integrated SAW (surface acoustic wave) delay line implements the high-Q VCO (voltage controlled oscillator) function, which results in low output phase noise and very low jitter. The M665-01 is available in a range of center frequencies from 125 to 177 MHz. The M665-02 provides 500 to 708 MHz. Guaranteed minimum pull-range of ± 120 ppm meets GbE requirements. (It also fully satisfies ± 50 ppm minimum pull-range specification commonly required.) Industry-standard K_{vco} (VCO Gain) provides full replacement compatibility. The M665 is well suited for phase-locked loop implementations, clock and data recovery circuits, and other timing applications in telecom and optical fiber networking systems (e.g., OC-48).



PIN ASSIGNMENT (9 x 14mm SMT)

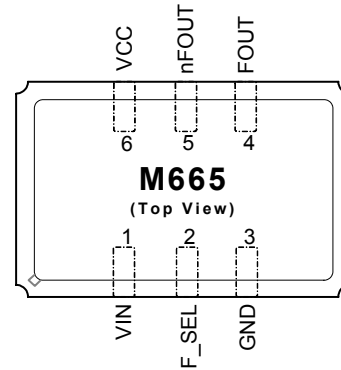

Figure 1: Pin Assignment

FEATURES

- ◆ Two integrated SAW devices and selectable output frequency; supports multi-rate optical interfaces
- ◆ M665-01 output frequencies from 125 to 177 MHz
M665-02 output frequencies from 500 to 708 MHz (Specify center frequencies at time of order)
- ◆ Industry-standard K_{vco} for full compatibility
- ◆ Low phase jitter 0.2ps rms typical for the M665-02 (50kHz to 80MHz)
- ◆ Differential 3.3V LVPECL output
- ◆ Single 3.3V power supply
- ◆ Small 9 x 14mm SMT (surface mount) package
- ◆ Compliant to EC RoHS Directive: SMT (6 of 6); J-Lead (5 of 6)

BLOCK DIAGRAM

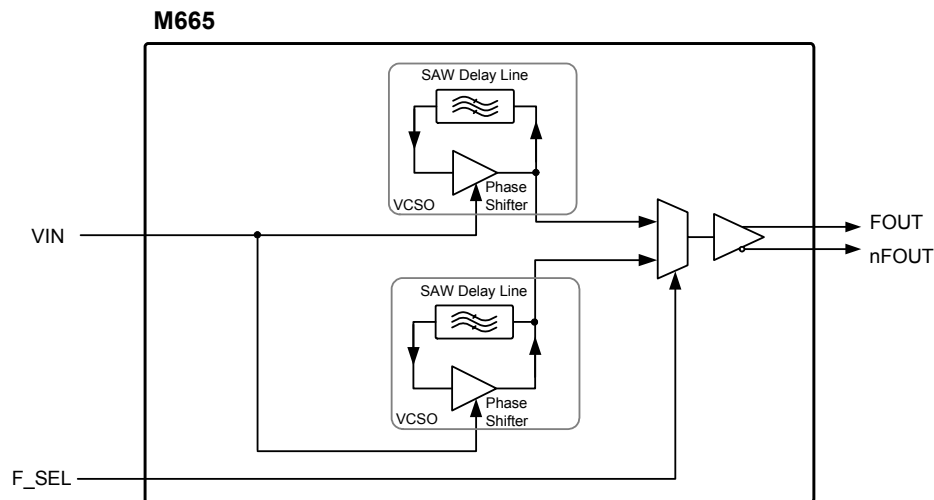

Figure 2: Block Diagram

Sample of Available Output Frequencies

VCSO Center Frequencies ¹ (MHz)	Applications
155.5200, 167.3316	SONET/SDH, SONET/SDH FEC
156.2500, 161.1328	Gigabit Ethernet, GbE FEC
622.0800, 669.3266	SONET/SDH, SONET/SDH FEC
625.0000, 644.5313	Gigabit Ethernet, GbE FEC

Table 1: Sample of Available Output Frequencies

Note 1: Specify VCSO center frequencies at time of order

PIN DESCRIPTIONS

Number	Name	I/O	Configuration	Description
1	VIN	Input		Frequency control input.
2	F_SEL	Input	Internal pull-down resistor ¹	Frequency select: Logic 1 selects Frequency 2. Logic 0 selects Frequency 1.
3	GND	Ground		Power supply ground connection.
4	FOUT	Output	No internal terminator	Clock output pair. Differential LVPECL.
5	nFOUT			
6	VCC	Power		Power supply connection, connect to +3.3V.

Table 2: Pin Descriptions

Note 1: See "Frequency Select" in Table 5 (DC Characteristics for M665-01 on pg. 3) and Table 7 (DC Characteristics for M665-02 on pg. 4).

ABSOLUTE MAXIMUM RATINGS¹

Symbol	Parameter	Rating	Unit
V _I	Inputs	-0.5 to V _{CC} +0.5	V
V _O	Outputs	-0.5 to V _{CC} +0.5	V
V _{CC}	Power Supply Voltage	4.6	V
T _S	Storage Temperature	-55 to +125	°C

Table 3: Absolute Maximum Ratings

Note 1: Stresses beyond those listed under Absolute Maximum Ratings may cause permanent damage to the device. These ratings are stress specifications only. Functional operation of product at these conditions or any conditions beyond those listed in Recommended Conditions of Operation, DC Characteristics, or AC Characteristics is not implied. Exposure to absolute maximum rating conditions for extended periods may affect product reliability.

RECOMMENDED CONDITIONS OF OPERATION

Symbol	Parameter	Min	Typ	Max	Unit
V _{CC}	Positive Supply Voltage	2.97	3.3	3.63	V
T _A	Ambient Operating Temperature	-40	25	+85	°C

Table 4: Recommended Conditions of Operation

ELECTRICAL SPECIFICATIONS FOR M665-01
DC Characteristics for M665-01
Unless stated otherwise, $V_{CC} = 3.3 \text{ Volts} \pm 10\%$, $T_A = 0 \text{ to } 85^\circ\text{C}$, VCSO Freq.'s = 155.52, 167.3316MHz, Outputs terminated into 180Ω to ground

	Symbol	Parameter	Pin	Min	Typ	Max	Unit
Power Supply	V_{CC}	Positive Supply Voltage	VCC	2.97	3.3	3.63	V
	I_{CC}	Power Supply Current			90	125	mA
Control Voltage	V_{IN}	Input Control Voltage Range	VIN	0		3.3	V
		V_{IN} Input Impedence			100		k Ω
Frequency Select ¹	V_{IH}	Input High Voltage		2		$V_{CC} + 0.3$	V
	V_{IL}	Input Low Voltage		-0.3		0.8	V
	I_{IH}	Input High Current	F_SEL			5	μA
	I_{IL}	Input Low Current		-150			μA
	$R_{pulldown}$	Internal Pull-down Resistor			51		k Ω
Differential Outputs	V_{OH}	Output High Voltage		$V_{CC} - 0.98$		$V_{CC} - 0.75$	V
	V_{OL}	Output Low Voltage		$V_{CC} - 1.95$		$V_{CC} - 1.63$	V
	V_{P-P}	Peak to Peak Output Voltage ²	FOUT, nFOUT	0.450	0.625	0.85	V_{P-P}
	I_{OUT}	Output Current				20	mA

Note 1: Internally pulled down to Logic 0 (Frequency 1) if left unselected.

Note 2: Single-ended measurement. See Figure 3, Output Rise and Fall Time, on pg. 5.

Table 5: DC Characteristics for M665-01
AC Characteristics for M665-01
Unless stated otherwise, $V_{CC} = 3.3 \text{ Volts} \pm 10\%$, $T_A = 0 \text{ to } 85^\circ\text{C}$, VCSO Freq.'s = 155.52, 167.3316MHz, Outputs terminated into 180Ω to ground

	Symbol	Parameter	Min	Typ	Max	Unit	Notes	
Control Voltage	V_{IN}	Modulation Bandwidth		600		kHz		
Output	F_{OUT}	Output Center Frequency Range M665-01	125		177	MHz		
	APR	Absolute (Guaranteed) Pull-Range ¹	± 120			ppm		
	f_{STAB}	Frequency Stability		100		ppm p-p	At any given V_{IN}	
	L_{IN}	Tuning Linearity		6		%	$V_{IN} = 0.3 \text{ to } 3.0\text{V}$ Best fit straight line	
	K_{VCO}	VCO Gain	@ 155.52MHz		400		ppm/V	$V_{IN} = 0.3 \text{ to } 3.0\text{V}$
			Non-harmonic Spurious	-50	-77		dBc	
	Φ_n	SSB (single sideband) Phase Noise, offset from carrier	100Hz Offset		-48		dBc/Hz	
			1kHz Offset		-75		dBc/Hz	
			10kHz Offset		-99		dBc/Hz	
			100kHz Offset		-124		dBc/Hz	
			1MHz Offset		-142		dBc/Hz	
	J(t)	Jitter (rms)	12kHz to 20MHz		0.30		ps rms	
			@ 155.52MHz	50kHz to 80MHz	0.18		ps rms	
	odc	Output Duty Cycle ²		45		55	%	
t_R	Output Rise Time ² for FOUT, nFOUT			275	425	ps	20% to 80%	
t_F	Output Fall Time ² for FOUT, nFOUT			275	425	ps	20% to 80%	

 Note 1: Also fully meets ± 50 ppm minimum pull-range specification that is commonly required.

Note 2: See Parameter Measurement Information on pg. 5.

Table 6: AC Characteristics for M665-01

ELECTRICAL SPECIFICATIONS FOR M665-02
DC Characteristics for M665-02
Unless stated otherwise, $V_{CC} = 3.3 \text{ Volts} \pm 10\%$, $T_A = 0 \text{ to } 85^\circ\text{C}$, VCSO Freq.'s = 622.08, 669.3266MHz, Outputs terminated into 180Ω to ground

	Symbol	Parameter	Pin	Min	Typ	Max	Unit
Power Supply	V_{CC}	Positive Supply Voltage	VCC	2.97	3.3	3.63	V
	I_{CC}	Power Supply Current			90	125	mA
Control Voltage	V_{IN}	Input Control Voltage Range	VIN	0		3.3	V
		V_{IN} Input Impedance			100		k Ω
Frequency Select ¹	V_{IH}	Input High Voltage		2		$V_{CC} + 0.3$	V
	V_{IL}	Input Low Voltage		-0.3		0.8	V
	I_{IH}	Input High Current	F_SEL			5	μA
	I_{IL}	Input Low Current		-150			μA
	$R_{pulldown}$	Internal Pull-down Resistor			51		k Ω
Differential Outputs	V_{OH}	Output High Voltage		$V_{CC} - 0.98$		$V_{CC} - 0.75$	V
	V_{OL}	Output Low Voltage		$V_{CC} - 1.95$		$V_{CC} - 1.63$	V
	V_{P-P}	Peak to Peak Output Voltage ²	FOUT, nFOUT	0.450	0.625	0.85	V_{P-P}
	I_{OUT}	Output Current				20	mA

Note 1: Internally pulled down to Logic 0 (Frequency 1) if left unselected.

Note 2: Single-ended measurement. See Figure 3, Output Rise and Fall Time, on pg. 5.

Table 7: DC Characteristics for M665-02
AC Characteristics for M665-02
Unless stated otherwise, $V_{CC} = 3.3 \text{ Volts} \pm 10\%$, $T_A = 0 \text{ to } 85^\circ\text{C}$, VCSO Freq.'s = 622.08, 669.3266MHz, Outputs terminated into 180Ω to ground

	Symbol	Parameter	Min	Typ	Max	Unit	Notes	
Control Voltage	V_{IN}	Modulation Bandwidth		600		kHz		
Output	F_{OUT}	Output Center Frequency Range M665-02	500		708	MHz		
	APR	Absolute (Guaranteed) Pull-Range ¹	± 120			ppm		
	f_{STAB}	Frequency Stability		100		ppm p-p	At any given V_{IN}	
	L_{IN}	Tuning Linearity		6		%	$V_{IN} = 0.3 \text{ to } 3.0\text{V}$ Best fit straight line	
	K_{VCO}	VCO Gain	@622.08MHz		400		ppm/V	$V_{IN} = 0.3 \text{ to } 3.0\text{V}$
			Non-harmonic Spurious	-50	-77		dBc	
	Φ_n	SSB (single sideband) Phase Noise, offset from carrier @622.08MHz	100Hz Offset		-42		dBc/Hz	
			1kHz Offset		-72		dBc/Hz	
			10kHz Offset		-102		dBc/Hz	
			100kHz Offset		-127		dBc/Hz	
			1MHz Offset		-146		dBc/Hz	
	J(t)	Jitter (rms) @622.08MHz	12kHz to 20MHz		0.22		ps rms	
			50kHz to 80MHz		0.16		ps rms	
	odc	Output Duty Cycle ²		45		55	%	
t_R	Output Rise Time ² for FOUT, nFOUT			275	400	ps	20% to 80%	
t_F	Output Fall Time ² for FOUT, nFOUT			275	400	ps	20% to 80%	

 Note 1: Also fully meets ± 50 ppm minimum pull-range specification that is commonly required.

Note 2: See Parameter Measurement Information on pg. 5.

Table 8: AC Characteristics for M665-02

PARAMETER MEASUREMENT INFORMATION

Output Rise and Fall Time

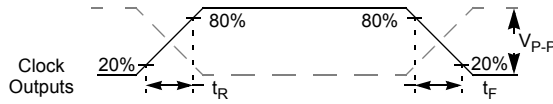

Figure 3: Output Rise and Fall Time

Output Duty Cycle

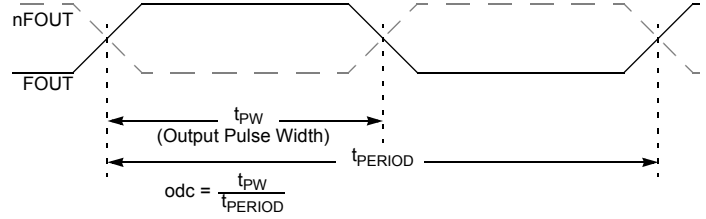
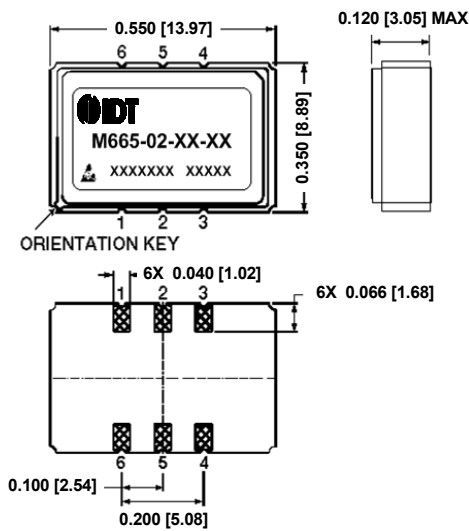

Figure 4: Output Duty Cycle

DEVICE PACKAGE - 9 x 14mm SMT and J-Lead Package

Mechanical Dimensions:

9 x 14 SMT (Surface Mount) Package



9 x 14 J-Lead Package

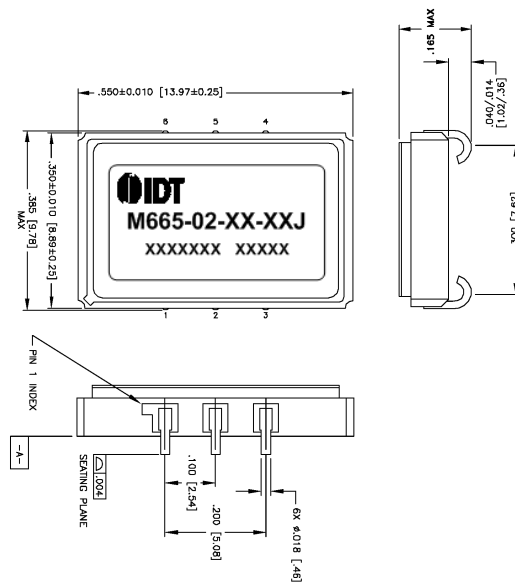

Dimensions are in mm;
 dimensions in [] are in inches
 Unless otherwise specified, all
 dimensions are ±0.13 [0.005]

Figure 5: 9 x 14mm Package Dimensions

ORDERING INFORMATION

Part Numbering Scheme

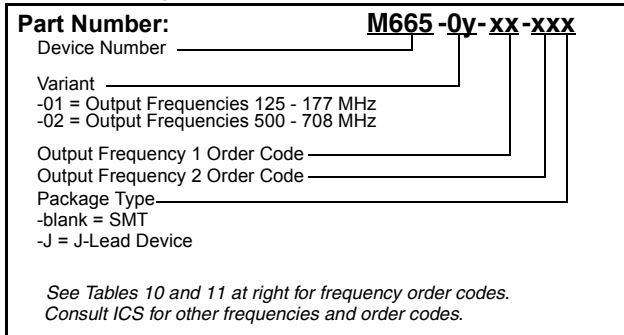

Figure 6: Part Numbering Scheme

Example Order Numbers

For Output Frequencies (MHz) <i>Frequency 1, Frequency 2</i>	Order Part Number M665-0y-xx-xx
155.5200, 167.3316	M665-01-BA-BH
156.2500, 161.1328; j-lead	M665-01-BB-BDJ
622.0800, 669.3266	M665-02-AA-AH
625.0000, 644.5313; j-lead	M665-02-AB-ADJ

Table 9: Example Order Numbers

M665-01 Standard Output Frequencies & Order Codes

125.0000 DA	167.2820 BF
153.6000 BO	167.3280 BG
155.5200 BA	167.3316 BH
156.2500 BB	167.7097 BI
156.8324 BC	168.0400 BJ
161.1328 BD	172.6423 BK
164.3555 BM	173.3708 BL
166.6286 BE	176.8382 BQ

Table 10: M665-01 Standard Output Frequencies & Order Codes

M665-02 Standard Output Frequencies & Order Codes

500.0000 CA	669.1281 AF
614.4000 AO	669.3120 AG
622.0800 AA	669.3266 AH
625.0000 AB	670.8386 AI
627.3296 AC	672.1600 AJ
644.5313 AD	690.5692 AK
657.4219 AM	693.4830 AL
666.5143 AE	707.3527 AQ

Table 11: M665-02 Standard Output Frequencies & Order Codes

Consult IDT for the availability of other frequencies

While the information presented herein has been checked for both accuracy and reliability, Integrated Device Technology (IDT) assumes no responsibility for either its use or for the infringement of any patents or other rights of third parties, which would result from its use. No other circuits, patents, or licenses are implied. This product is intended for use in normal commercial applications. Any other applications such as those requiring extended temperature range, high reliability, or other extraordinary environmental requirements are not recommended without additional processing by IDT. IDT reserves the right to change any circuitry or specifications without notice. IDT does not authorize or warrant any IDT product for use in life support devices or critical medical instruments.