

**ebm-papst St. Georgen GmbH & Co. KG**

Hermann-Papst-Str. 1
 D-78112 St. Georgen
 Phone +49 (0) 7724 81-0
 Fax +49 (0) 7724 81-1309
 info2@de.ebmpapst.com
 www.ebmpapst.com

Nominal data

Type	612 JH	
Nominal voltage	VDC	12
Nominal voltage range	VDC	7 .. 13.6
Speed (rpm)	min ⁻¹	11700
Power consumption	W	7.7
Min. ambient temperature	°C	-20
Max. ambient temperature	°C	70
Air flow	m ³ /h	70
Sound power level	B	6.4
Sound pressure level	dB(A)	53

ml = Max. load · me = Max. efficiency · fa = Free air · cs = Customer specification · ce = Customer equipment
 Subject to change



Technical description

Housing material	Glass-fiber reinforced PBT plastic
Impeller material	Glass-fiber reinforced PA plastic
Weight	0.100 kg
Dimensions	60 x 60 x 32 mm
Airflow direction	Exhaust over struts
Direction of rotation	Clockwise, viewed toward rotor
Storage	Ball bearing
Service life L10 at 40 °C	57500 h
Service life L10 at maximum temperature	27500 h
Cable	Leads AWG 24, TR 64, stripped and tin-plated.
Motor protection	Protection against reverse polarity and blocked rotor.
Locked-rotor protection	With electronic locked-rotor and overload protection
Approval	CE
Option	Possible custom designs: Speed signal Go / No-go alarm Alarm with speed limit External temperature sensor PWM control input Analog control input Moisture protection

Product drawing

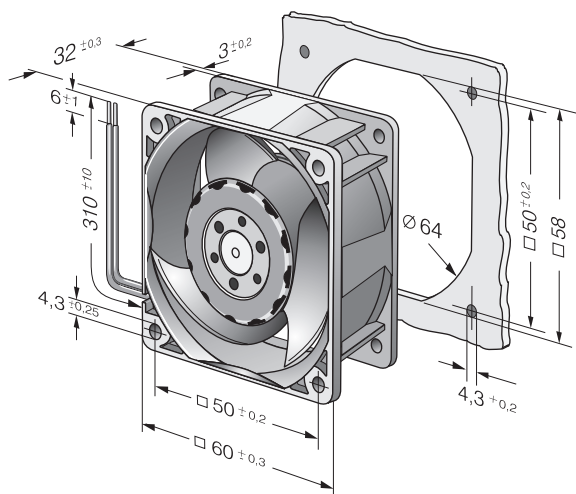

Curves: Air performance

