

General Description

The AAT4902 is a member of Skyworks' Application Specific Power MOSFET (ASPM™) product family. It is a full-bridge, constant output voltage power stage operating with supply voltage range of 2.5V to 5.5V. The output states of AAT4902 are controlled by the input signals according to the input to output logic table. The output high voltage V_{OH} is equal to 2.0 times of V_{LIM} (the constant voltage setting point voltage) when $V_{LIM} \leq V_M/2$ or equal to V_M (the motor supply voltage) when $V_{LIM} > V_M/2$. AAT4902 is protected from shoot-through current by integrated break-before-make circuitry.

The internal over-temperature protection circuitry turns off the device when an over-temperature fault occurs and recovers automatically when the fault is removed.

The AAT4902 is offered in the Pb-free, 9-pin wafer-level chip-scale package (WLCSP) package and is specified over the -40°C to +85°C temperature range.

Features

- Wide Supply Voltage Range
 - V_{DD} Range: 2.5V to 5.5V
 - V_M Range: 2.5V to 5.5V
- One Channel Constant Output Voltage Driver
- Low Quiescent Mode
 - 70µA in Quiescent Mode
 - Less than 1µA in Shutdown Mode
- Over-Temperature Protection
- ±400mA Maximum Output Current
- -40°C to 85°C Temperature Range
- WLCSP-9 Package

Applications

- Digital Still Cameras (DSCs)
- Smart Phones

Typical Application

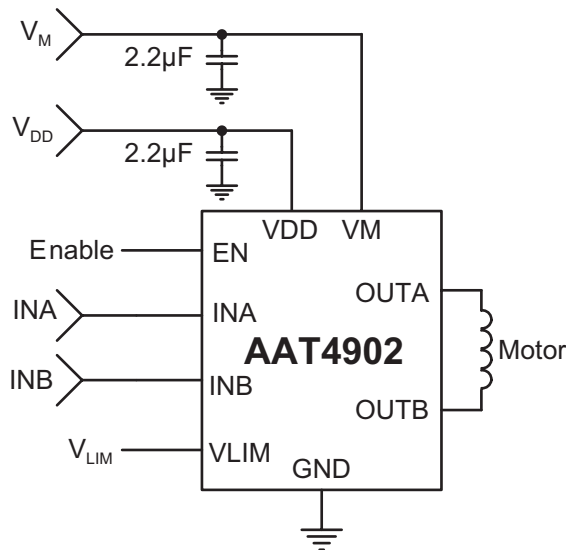

One-Channel Full-Bridge Motor Driver**Pin Descriptions**

Pin #	Symbol	Description
A1	OUTA	Output of the constant voltage H bridge.
A2	VM	Motor power supply stage.
A3	OUTB	Output of the constant voltage H bridge
B1	INA	Input logic signal to control the output driver stage together with INB according to the input-output table.
B2	PGND	Power ground of the output driver stage.
B3	INB	Input logic signal to control the output driver stage together with INA according to the input-output table.
C1	VDD	Supply voltage for the control circuit.
C2	EN	Enable control; active high.
C3	VLIM	Constant output voltage setting signal.

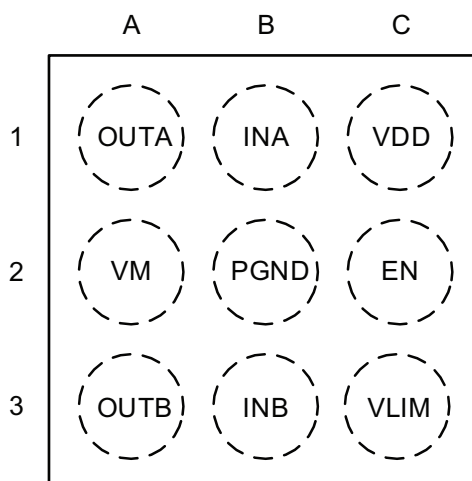
Pin Configuration**WLCSP-9
(Top View)**

One-Channel Full-Bridge Motor Driver**Absolute Maximum Rating** $T_A = 25^\circ\text{C}$.

Symbol	Description	Value	Units
V_{DD}	Power Supply Voltage	-0.3 to 6.0	V
V_M	Motor Power Supply Voltage	-0.3 to 6.0	V
V_{IN}	Control Input Voltage	-0.3 to $V_{DD} + 0.3$	V
V_{LIM}	Constant-Voltage Setting	-0.3 to $V_M + 0.3$	V
P_D	Power Dissipation	704	mW
T_{OPR}	Operating Temperature Range	-40 to 85	$^\circ\text{C}$
T_{JMAX}	Junction Temperature	150	$^\circ\text{C}$
T_{STG}	Storage Temperature Range	-55 to +150	$^\circ\text{C}$
I_{OUT}	H-Bridge Output Current	-500 to +500	mA/ch

Thermal Consideration

Symbol	Description	Value	Units
P_D	Maximum Power Dissipation	704	mW
θ_{JA}	Thermal Resistance	142	mW/ $^\circ\text{C}$
T_J	Operating Junction Temperature Range	-40 to 150	$^\circ\text{C}$

Recommended Operating Conditions $T_A = -40^\circ\text{C}$ to $+85^\circ\text{C}$.

Symbol	Description	Min	Typ	Max	Units
V_{DD}	Power Supply Voltage	2.5	3.0	5.5	V
V_M	Motor Power Supply Voltage	2.5	5.0	5.5	V
V_{IN}	Control Input Voltage	0		V_{DD}	V
V_{LIM}	Constant-Voltage Setting	0		V_M	V
I_{OUT}	H-Bridge Output Current			± 400	mA

One-Channel Full-Bridge Motor Driver**Electrical Characteristics**

$T_A = 25^\circ\text{C}$, $V_{DD} = 3.0\text{V}$, $V_M = 5.0\text{V}$ unless otherwise specified.

Symbol	Description	Conditions	Min	Typ	Max	Units
I_S	Shutdown Current	$V_{EN} = 0$		0	1	μA
I_{OP}	Operating Current	$V_{EN} = V_{INA} = V_{DD}$, $V_{INB} = 0\text{V}$, $I_{VDD} + I_{VM}$, No Load		450		μA
I_Q	Quiescent Current	$V_{EN} = V_{DD}$, $V_{INA} = V_{INB} = 0\text{V}$, $I_{VDD} + I_{VM}$		70		μA
V_{INH}	Input Voltage High		2			V
V_{INL}	Input Voltage Low				0.7	V
I_{INH}	High Level Input Current	$V_{IN} = 3\text{V}$	15	30	60	μA
I_{INL}	Low Level Input Current	$V_{IN} = 0\text{V}$	-1	0		μA
R_{IN}	Pull-down Resistor		50	100	200	$\text{k}\Omega$
I_{VLIM}	Constant Voltage Control Input Current		-1.5	-0.5		μA
V_{UVLO}	UVLO Voltage		1.6		2.4	V
R_{ON}	Output On-Resistance	$I_{OUT} = \pm 400\text{mA}$, $V_M = 5.0\text{V}$, high and low sides in total		0.65	1.2	Ω
V_{OH}	Output H Voltage	$V_{LIM} = 1\text{V}$, 10Ω Load	1.9	2	2.1	V
T_{ON}	Turn-On Time	$I_{OUT} = \pm 150\text{mA}$, 10Ω Load		1.5	3	μs
T_{OFF}	Turn-Off Time	$I_{OUT} = \pm 150\text{mA}$, 10Ω Load		0.1	1	μs
T_R	Rise Time	$I_{OUT} = \pm 150\text{mA}$, 10Ω Load		0.2	4	μs
T_F	Fall Time	$I_{OUT} = \pm 150\text{mA}$, 10Ω Load		0.02	0.5	μs
T_{SD}	Over-Temperature Threshold			150		$^\circ\text{C}$
T_{HYS}	Over-Temperature Hysteresis			15		$^\circ\text{C}$

AAT4902

One-Channel Full-Bridge Motor Driver

Timing Diagram

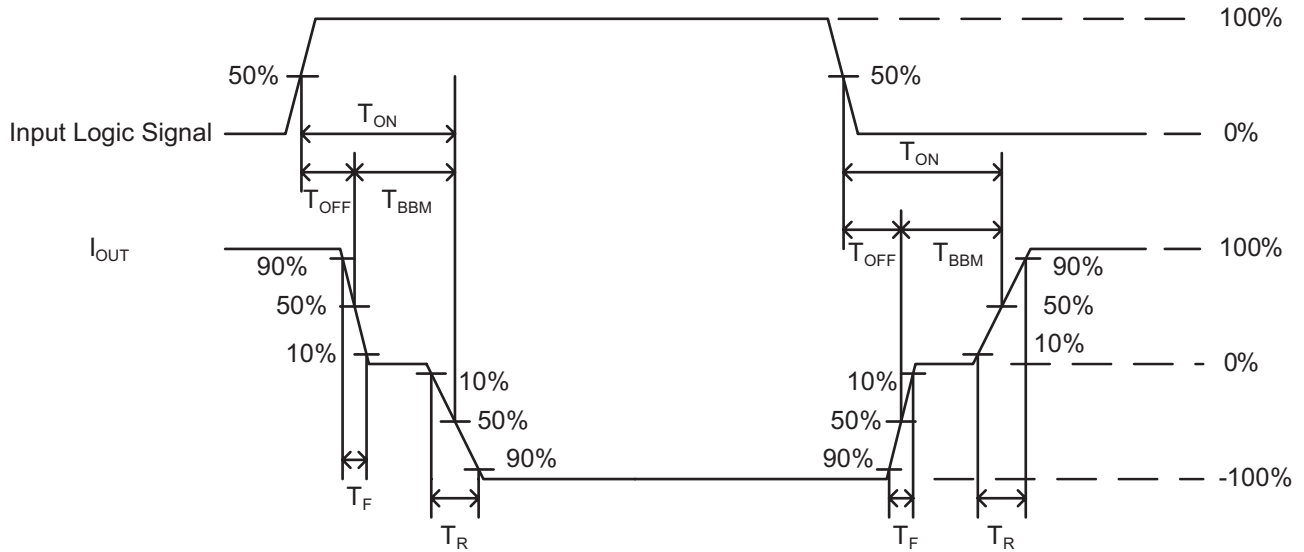

AAT4902

One-Channel Full-Bridge Motor Driver

Typical Characteristics

Operating Current vs. Temperature

($V_M = 5V$; $V_{LIM} = 0.75V$; $V_{EN} = 3V$; $V_{INA} = 3V$; $V_{INB} = 0V$; No Load)

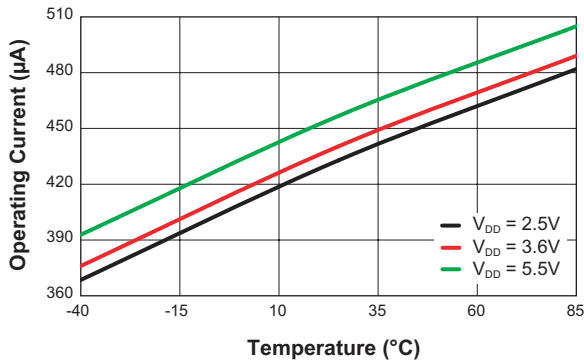

Operating Current vs. Power Supply Voltage

($V_M = 5V$; $V_{LIM} = 0.75V$; $V_{EN} = 3V$; $V_{INA} = 3V$; $V_{INB} = 0V$; No Load)

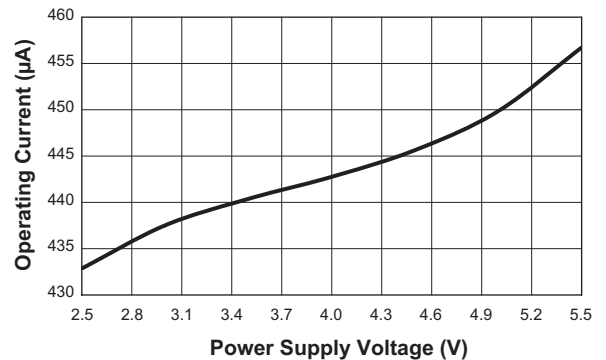

Quiescent Current vs. Temperature

($V_M = 5V$; $V_{LIM} = 0.75V$; $V_{EN} = 3V$; $V_{INA} = V_{INB} = 0V$)

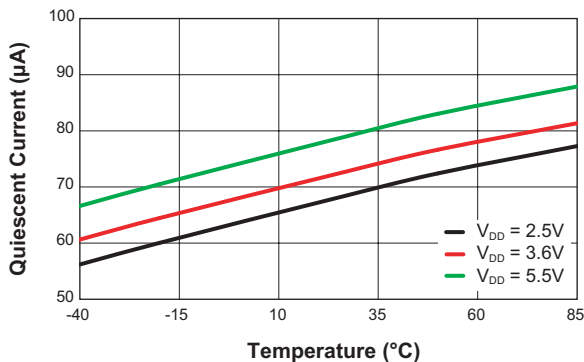

Quiescent Current vs. Power Supply Voltage

($V_M = 5V$; $V_{LIM} = 0.75V$; $V_{EN} = 3V$; $V_{INA} = V_{INB} = 0V$)

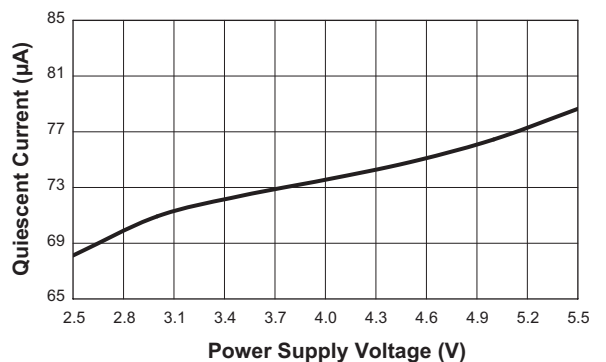

EN Input High Threshold Voltage vs. Power Supply Voltage

($V_M = 5V$; $V_{LIM} = 1V$; $V_{INA} = 3V$; $V_{INB} = 0V$)

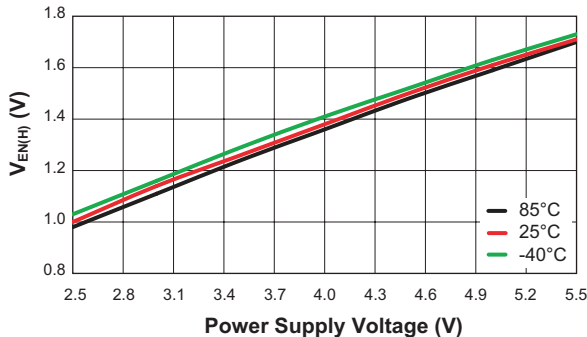

EN Input Low Threshold Voltage vs. Power Supply Voltage

($V_M = 5V$; $V_{LIM} = 1V$; $V_{INA} = 3V$; $V_{INB} = 0V$)

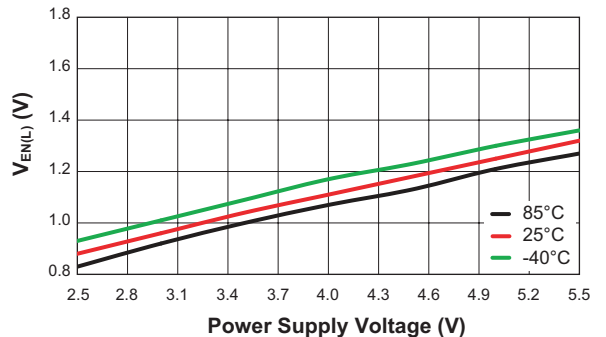

Typical Characteristics

INA/B Input High Threshold Voltage vs. Power Supply Voltage
($V_M = 5V$; $V_{LIM} = 1V$; $V_{EN} = 3V$)

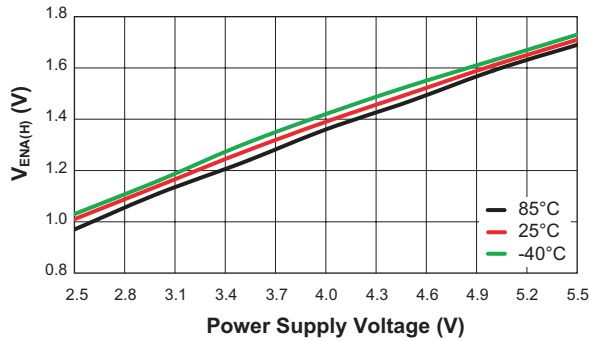

INA/B Input Low Threshold Voltage vs. Power Supply Voltage
($V_M = 5V$; $V_{LIM} = 1V$; $V_{EN} = 3V$)

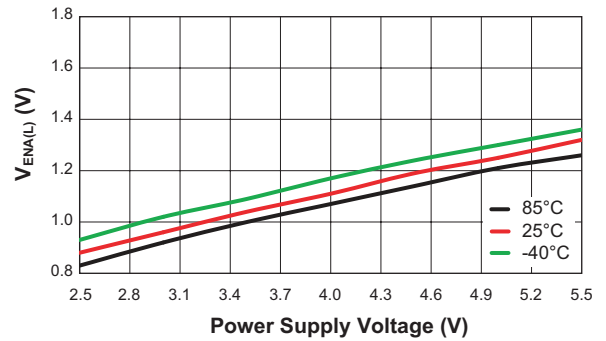

Shutdown Current vs. Temperature
($V_M = 5V$; $V_{LIM} = 1V$; $V_{EN} = V_{INA} = V_{INB} = 0V$)

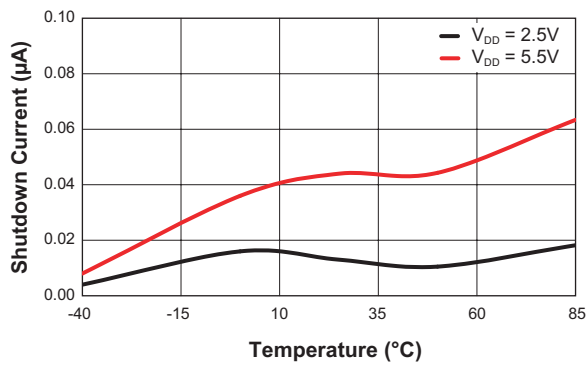

Output H Voltage vs. V_LIM
($V_M = 5V$; $V_{DD} = 3V$; $V_{EN} = V_{INA} = 3V$; $V_{INB} = 0V$)

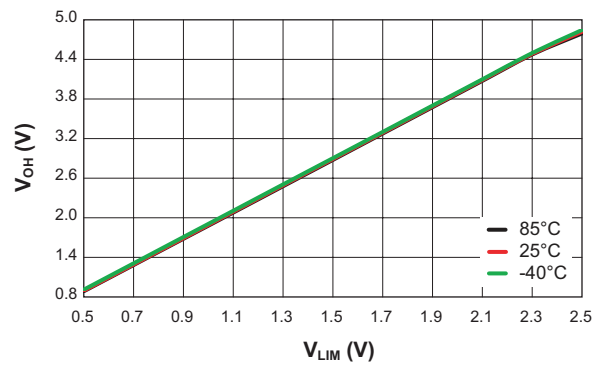

High Side $R_{DS(ON)}$ vs. Temperature
($V_M = 5V$; $V_{LIM} = 3V$; $V_{EN} = V_{INA} = 3V$; $V_{INB} = 0V$; $I_{OUT} = 0.4A$)

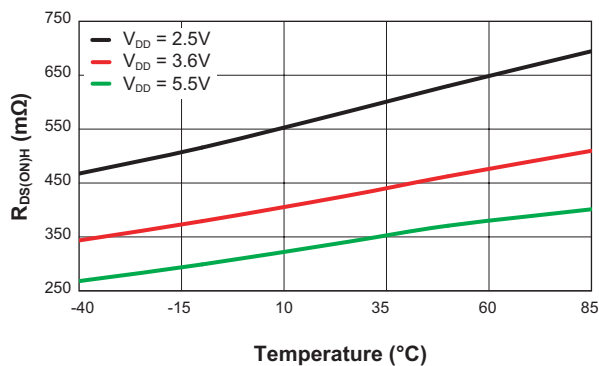

Low Side $R_{DS(ON)}$ vs. Temperature
($V_M = 5V$; $V_{LIM} = 3V$; $V_{EN} = V_{INB} = 3V$; $V_{INA} = 0V$; $I_{OUT} = 0.4A$)

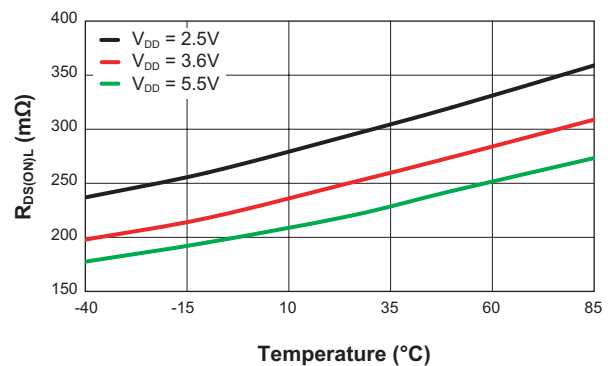

AAT4902

One-Channel Full-Bridge Motor Driver

Typical Characteristics

High Side $R_{DS(ON)}$ vs. Output Current
 ($V_M = 5V$; $V_{LIM} = 3V$; $V_{EN} = V_{INA} = 3V$; $V_{INB} = 0V$)

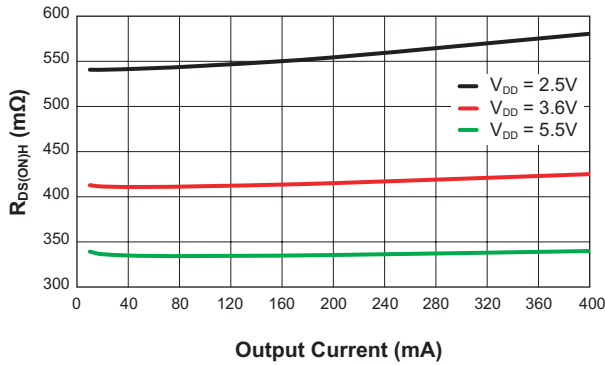

Low Side $R_{DS(ON)}$ vs. Output Current
 ($V_M = 5V$; $V_{LIM} = 3V$; $V_{EN} = V_{INB} = 3V$; $V_{INA} = 0V$)

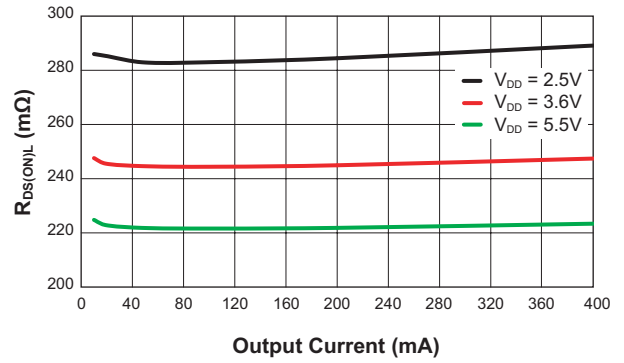

MOSFETs $R_{DS(ON)}$ vs. Power Supply Voltage
 ($V_M = 5V$; $V_{LIM} = 3V$; $V_{EN} = 3V$; $I_{OUT} = 0.4A$)

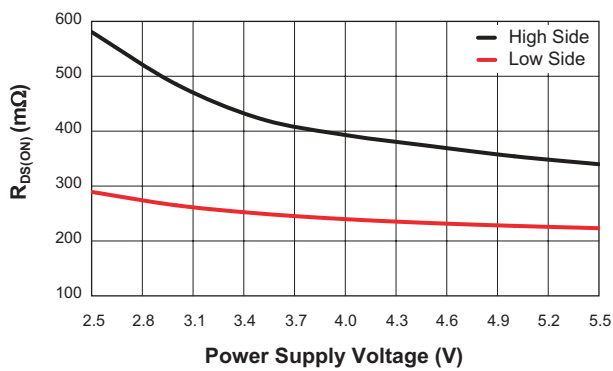

Input-Output Logic
 ($V_{DD} = V_M = V_{INA} = V_{INB} = V_{LIM} = 3.6V$)

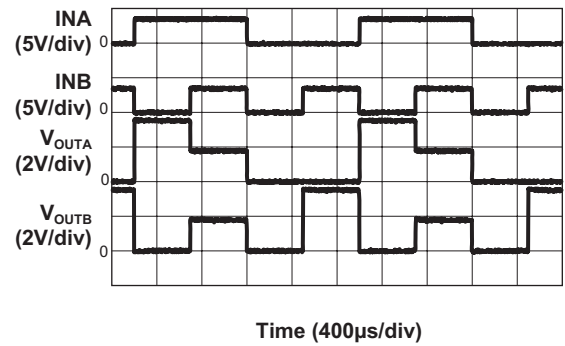

Turn On

($V_{DD} = V_M = 3.6V$; $V_{LIM} = 0.75V$; $I_{LOAD} = 150mA$)

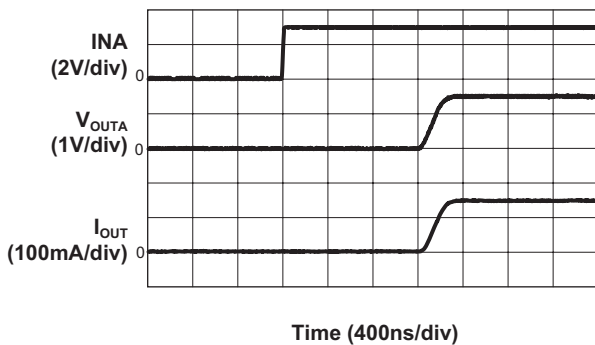

Turn Off

($V_{DD} = V_M = 3.6V$; $V_{LIM} = 0.75V$; $I_{LOAD} = 150mA$)

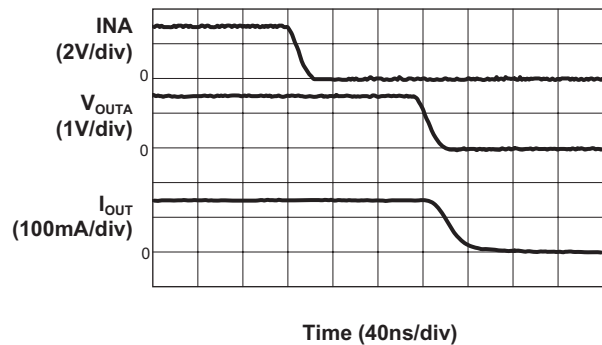

Functional Block Diagram

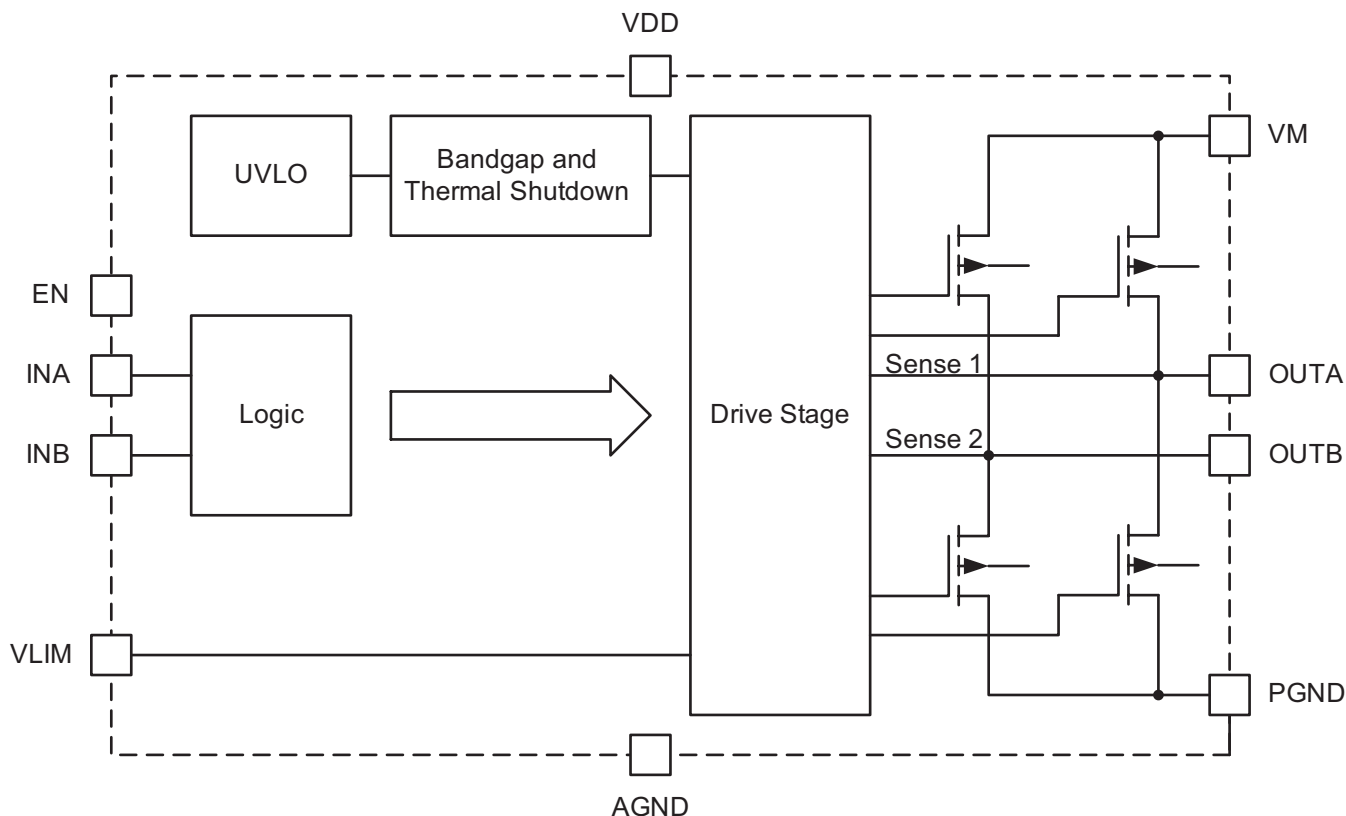

Functional Description

The AAT4902 is a full bridge driver configured with two half bridges. Each half bridge's high-side MOSFET will be turned on when INA/B is driven high, and the low-side MOSFET will be turned off when INA/B is driven low. Each channel of AAT4902 can supply $\pm 400\text{mA}$ to load. The device operating current is $70\mu\text{A}$ typical with $V_{DD} = V_M = 5.0\text{V}$ and no input signal. When the enable pin (EN) is set to low, the device is turned off and the shutdown current is less than $0.1\mu\text{A}$. The AAT4902 is protected from shoot-through current by the integrated break-before-make circuitry.

Output H Voltage

The output H voltage (V_{OH}) can be programmed by setting the VLIM pin (constant output voltage setting pin): When $V_{LIM} \leq V_M/2$, the output H voltage (V_{OH}) is equal to 2.0 times V_{LIM} ; when $V_{LIM} > V_M/2$, the output H voltage (V_{OH}) approximates V_M voltage.

Input-Output Logic Table

The AAT4902 is configured with two input control pins, INA and INB. The control pins are active high to enable the H-bridge outputs. If INA and INB are in anti-phase, the device provides forward/reverse signal to drive the motor.

Table 1 shows the Input-Output logic for the AAT4902.

Input		Output	
INA	INB	OUTA	OUTB
L	L	L	L
L	H	L	H
H	L	H	L
H	H	Z	Z

Table 1: AAT4902 Input-Output Logic Table.

Note: When Z is the Constant-Voltage Driver state both top and bottom power MOSFETs are turned off.

Application Information

Supply Capacitor

The supply capacitor provides a low impedance loop for the edges of pulsed current drawn by the AAT4902 and reduces the surge current drawn from the input power. A 2.2 μ F or larger X7R or X5R low ESR/ESL ceramic capacitor is selected for the power supply decoupling. The capacitor should be placed as closely as possible to the VDD pin. This keeps the high frequency content of input current localized, minimizing EMI and supply voltage ripple.

Output H Voltage

The output H voltage (V_{OH}) can be programmed by setting V_{LIM} (constant output voltage setting voltage); the V_M voltage should never be exceeded:

$$V_{OH} = 2.0 \cdot V_{LIM}$$

(Voltage in V; when $V_{LIM} > V_M/2$, output H voltage is equal to the V_M voltage)

For example, if V_{LIM} is 1.0V and V_M is 5.0V, then the output H voltage (V_{OH}) is 2.0V typical.

Figure 1 shows the relation between the output H voltage (V_{OH}) and V_{LIM} .

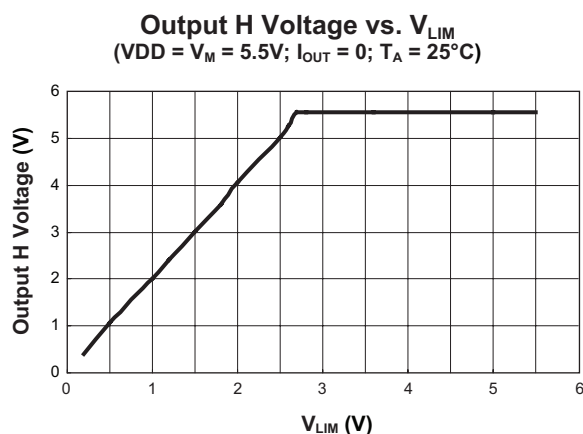

Figure 1: Output H Voltage vs. V_{LIM} .

Shoot-Through Protection

The internal high-side and low-side MOSFETs of the AAT4902 cannot conduct at the same time to prevent shoot-through current. When the high-side MOSFET turns on, the low-side MOSFET turns off first; after break-before-make time (T_{BBM} ; see Timing Diagram), the high-side MOSFET then turns on. Similarly, before the low-side MOSFET turns on, the high-side MOSFET turns off; after a certain break-before-make time (T_{BBM}), the low-side MOSFET turns on. The dead time between the high-side and low-side turn-on should be kept as low as possible to minimize current flows through the body diode of the high-side and/or low-side MOSFET(s). The break-before-make shoot-through protection significantly reduces losses associated with the driver at high frequency.

Over-Temperature Protection

Over-temperature protection is active and disables the AAT4902 when the die temperature of the device exceeds t_{SD} (150°C). When the fault is removed by the die temperature dropping below t_{SD} minus the hysteresis of 15°C, the AAT4902 automatically recovers to normal operation.

Thermal Calculations

The AAT4902 can provide $\pm 400\text{mA}$ output current to drive a motor. The limiting characteristic for the maximum output power is essentially package power dissipation and the device's internal thermal limit. At any given ambient temperature (T_A), the maximum package power dissipation can be determined by the following equation:

$$P_{D(MAX)} = \frac{T_{J(MAX)} - T_A}{\theta_{JA}}$$

Where:

$T_{J(MAX)}$ = junction temperature of the die (125°C)

T_A = ambient temperature (25°C)

θ_{JA} = thermal resistance (142°C/W)

AAT4902

One-Channel Full-Bridge Motor Driver

Typical Application Circuit

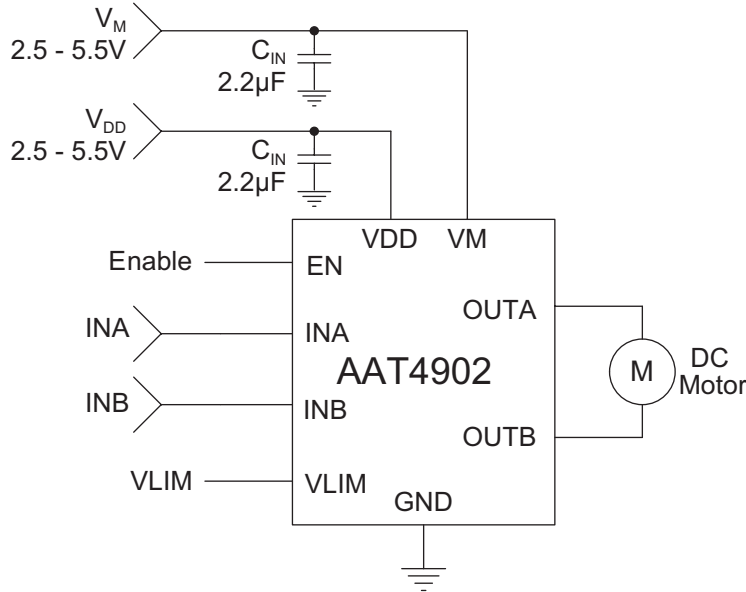
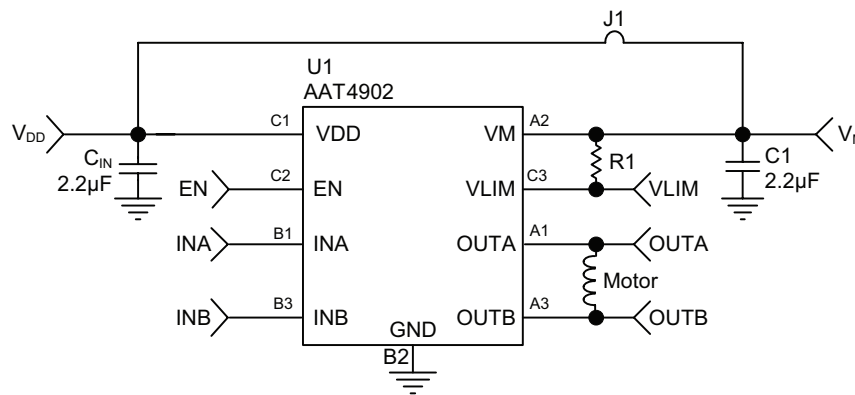

Figure 2: Full Bridge Motor Driver Application Using AAT4902.

Evaluation Board Schematic



U1: AAT4902IUR
 C1, C_{IN} : 0603 X7R 2.2 μF 10V GRM188R71A225KE15

Figure 3: AAT4902 Evaluation Board Schematic.

Evaluation Board Layout

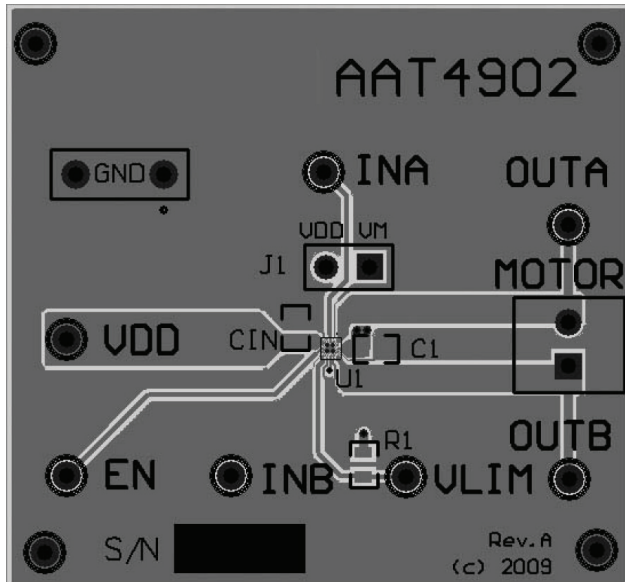

Figure 4: AAT4902 Evaluation Board Top Side Layout.

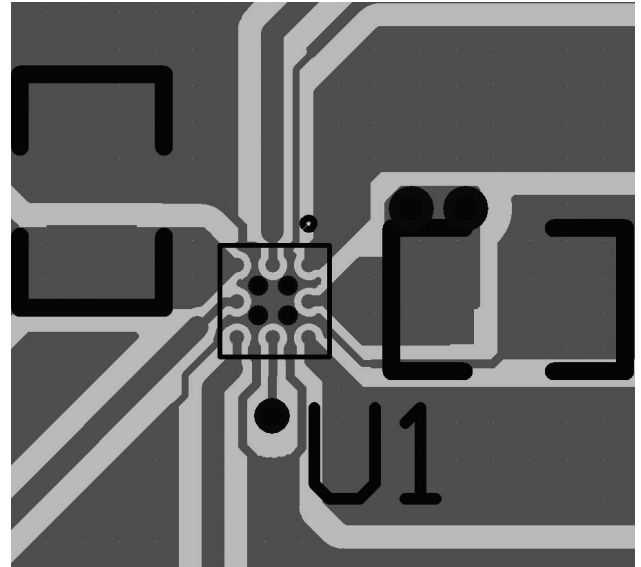

Figure 5: AAT4902 Evaluation Board Top Side Layout (detail).

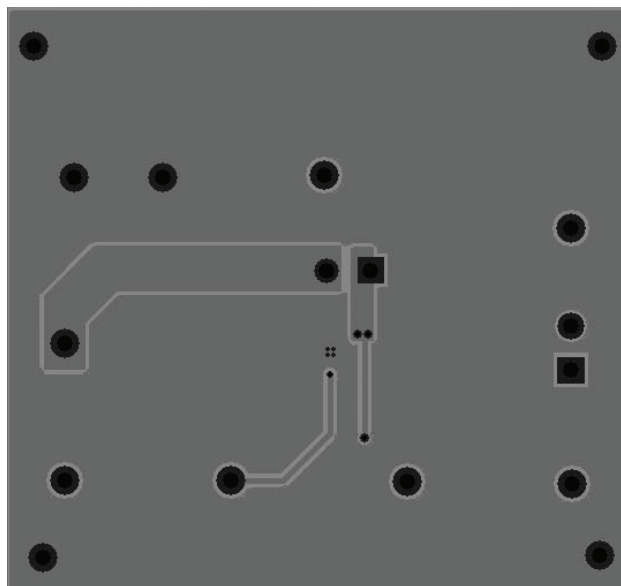

Figure 6: AAT4902 Evaluation Board Bottom Side Layout.

