

RELEASABLE SMT POKE-IN

WIRE CONNECTOR

TE Connectivity's low profile, SMT releasable poke-in wire connector accommodates multiple design requirements with 1, 2 & 3 position connector configurations. The releasable poke-in wire connector features an integral conductor release mechanism, recessed below the top side of the connector and cannot be compromised or broken during multiple insertion and release cycles. Ideal for LED lighting applications, the surface mount releasable poke-in connectors accept 18 to 22 gauge solid and stranded conductors and are tape and reel packaged for high speed SMT processing.

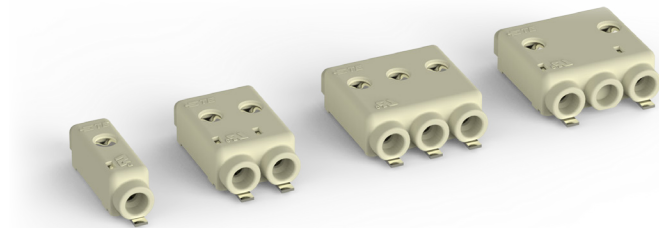

Mechanical

- Operating temperature: -40°C to 130°C

Electrical

- Current rating: 18 AWG wire - 9 A
20-22 AWG wire - 5 A
- Voltage rating: 600 VAC/DC

Materials

- Housing: UL 94 V0 high temperature resistant thermoplastic
- Contacts: Tin over nickel plated copper alloy

Applications and Specifications

- Application specification: 114-32113
- Product specification: 108-32063
- UL and cUL recognized: File No. E28476

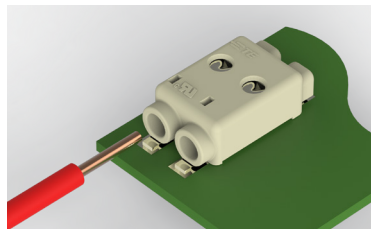

Insert solid conductors horizontal to printed circuit board to complete termination

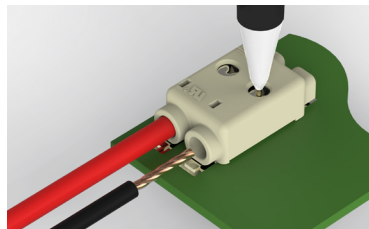

Insert stranded conductors horizontal to printed circuit boards and/or remove both solid and stranded conductors by first depressing the release mechanism with a ball point pen or the tip of any small device. Remove the conductors by pulling horizontal to the printed circuit board.

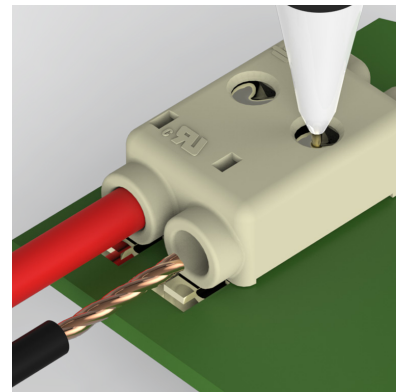

Key Benefits

- Automated production with flat top surface for vacuum pick up and high temperature material for re-flow processing
- Low profile design and rounded corners prevent obstruction of LED lighting and minimizes shadowing
- Side by side stackable design on 4 mm spacing supports higher connection variations, minimizes part number inventory and lowers production costs
- Integral robust wire release mechanism to help prevent damage during wire assembly and rework
- Requires no specialized tools for wire insertion or removal
- Accommodates multiple design requirements with 1, 2 & 3 position connector configurations
- Support high voltage connections with a 2 position 8 mm centerline version
- Accepts 18 - 22 gauge solid, stranded or pre-bond conductors in AWG or metric sizes to support global applications
- Prevent obstruction of LED lights with a low profile design and rounded corners to minimize shadows

Applications

- Linear or circular LED light modules
- Metering and control terminal block connections
- Power to contact boards in applications and building equipment

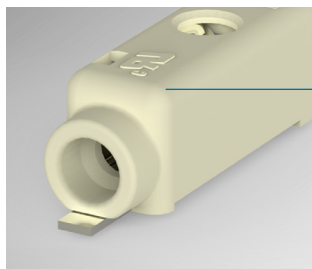

1

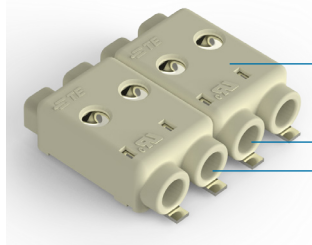

2

3

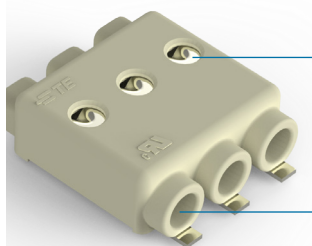

4

5

Releasable Poke-in Wire Connector Features

- 1 Low profile design and rounded corners prevent obstruction of LED light and minimizes shadowing
- 2 Flat top surface for vacuum pick up
- 3 Side by side stackable on 4 mm centers
- 4 Recessed release mechanism eliminates multi-surface features on top of connector and cannot be pried upward during conductor insertion eliminating potential for breakage
- 5 Integral terminal release confines wire on all four sides inside terminal housing ensuring secure connection

Wire types and sizes accepted

- Solid wire: 18, 20, 22 AWG, 0.75 and 0.34 mm²
- Stranded wire: 18 AWG & 0.5 mm², 16 strands max, 20, 22 AWG, 7 strands max
0.75 mm² 24 strands max
0.34 mm² 19 strands max
- Prebond wire: 18 AWG, 16 strands max
20 AWG, 7 strands max
- Max insulation OD: 2.5 mm (.098") max
- Strip Length: 9.0 mm ± 1.0 (0.354" ± 0.039)

Product Offering

No. of Positions	TE Part No.	"A" Dimension	"B" Dimension
1 Position	2213301-1	3.90 mm	12.00 mm
2 Position	2213301-2	7.90 mm	16.00 mm
3 Position	2213301-3	11.90 mm	20.00 mm
2 Position High Voltage	1-2213301-2	11.90 mm	20.00 mm

Dimensions

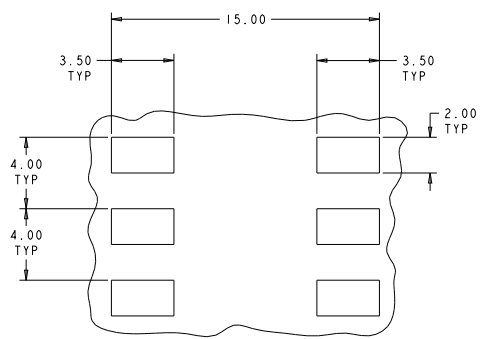
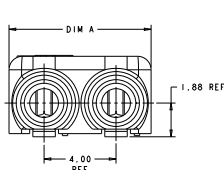
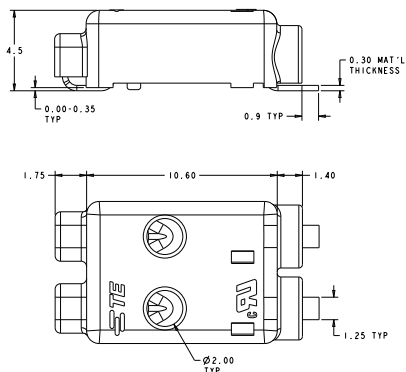

Recommended PCB Layout

Tape and Reel Packaging Diagram - 2213301-2 shown for reference

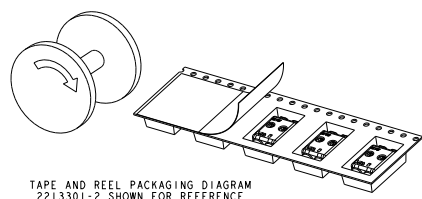

TAPE AND REEL PACKAGING DIAGRAM
2213301-2 SHOWN FOR REFERENCE

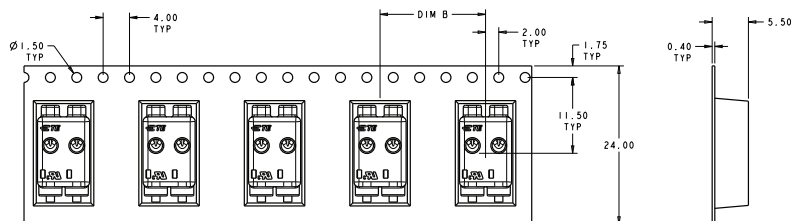

For More Information

te.com/ib

TE Technical Support Center

- Internet: te.com
- USA: 1-800-522-6752
- Canada: +1-905-475-6222
- Mexico: +52 (0) 55-1106-0800
- Latin/S. America +54 (0) 11-4733-2200
- Germany: +49 (0) 6251-133-1999
- UK: +44 (0) 800-267666
- France: +33 (0) 1-3420-8686
- Netherlands: +31 (0) 73-6246-999
- China: +86 (0) 400-820-6015

te.com

© 2014 TE Connectivity Ltd. family of companies. All Rights Reserved

TE Connectivity and TE connectivity (logo) are trademarks. Other logos, product and/or company names might be trademarks of their respective owners.

1-1773730-4 JG9b PDF 07/2014