



**MICROCHIP**

---

**MCP19111  
Battery Charger  
Evaluation Board  
User's Guide**

---

**Note the following details of the code protection feature on Microchip devices:**

- Microchip products meet the specification contained in their particular Microchip Data Sheet.
- Microchip believes that its family of products is one of the most secure families of its kind on the market today, when used in the intended manner and under normal conditions.
- There are dishonest and possibly illegal methods used to breach the code protection feature. All of these methods, to our knowledge, require using the Microchip products in a manner outside the operating specifications contained in Microchip's Data Sheets. Most likely, the person doing so is engaged in theft of intellectual property.
- Microchip is willing to work with the customer who is concerned about the integrity of their code.
- Neither Microchip nor any other semiconductor manufacturer can guarantee the security of their code. Code protection does not mean that we are guaranteeing the product as "unbreakable."

Code protection is constantly evolving. We at Microchip are committed to continuously improving the code protection features of our products. Attempts to break Microchip's code protection feature may be a violation of the Digital Millennium Copyright Act. If such acts allow unauthorized access to your software or other copyrighted work, you may have a right to sue for relief under that Act.

---

Information contained in this publication regarding device applications and the like is provided only for your convenience and may be superseded by updates. It is your responsibility to ensure that your application meets with your specifications. MICROCHIP MAKES NO REPRESENTATIONS OR WARRANTIES OF ANY KIND WHETHER EXPRESS OR IMPLIED, WRITTEN OR ORAL, STATUTORY OR OTHERWISE, RELATED TO THE INFORMATION, INCLUDING BUT NOT LIMITED TO ITS CONDITION, QUALITY, PERFORMANCE, MERCHANTABILITY OR FITNESS FOR PURPOSE. Microchip disclaims all liability arising from this information and its use. Use of Microchip devices in life support and/or safety applications is entirely at the buyer's risk, and the buyer agrees to defend, indemnify and hold harmless Microchip from any and all damages, claims, suits, or expenses resulting from such use. No licenses are conveyed, implicitly or otherwise, under any Microchip intellectual property rights.

**Trademarks**

The Microchip name and logo, the Microchip logo, dsPIC, FlashFlex, flexPWR, JukeBlox, KEELOQ, KEELOQ logo, Kleer, LANCheck, MediaLB, MOST, MOST logo, MPLAB, OptoLyzer, PIC, PICSTART, PIC<sup>32</sup> logo, RightTouch, SpyNIC, SST, SST Logo, SuperFlash and UNI/O are registered trademarks of Microchip Technology Incorporated in the U.S.A. and other countries.

The Embedded Control Solutions Company and mTouch are registered trademarks of Microchip Technology Incorporated in the U.S.A.

Analog-for-the-Digital Age, BodyCom, chipKIT, chipKIT logo, CodeGuard, dsPICDEM, dsPICDEM.net, ECAN, In-Circuit Serial Programming, ICSP, Inter-Chip Connectivity, KleerNet, KleerNet logo, MiWi, MPASM, MPF, MPLAB Certified logo, MPLIB, MPLINK, MultiTRAK, NetDetach, Omniscient Code Generation, PICDEM, PICDEM.net, PICkit, PICtail, RightTouch logo, REAL ICE, SQI, Serial Quad I/O, Total Endurance, TSHARC, USBCheck, VariSense, ViewSpan, WiperLock, Wireless DNA, and ZENA are trademarks of Microchip Technology Incorporated in the U.S.A. and other countries.

SQTP is a service mark of Microchip Technology Incorporated in the U.S.A.

Silicon Storage Technology is a registered trademark of Microchip Technology Inc. in other countries.

GestIC is a registered trademarks of Microchip Technology Germany II GmbH & Co. KG, a subsidiary of Microchip Technology Inc., in other countries.

All other trademarks mentioned herein are property of their respective companies.

© 2014, Microchip Technology Incorporated, Printed in the U.S.A., All Rights Reserved.

ISBN: 978-1-63276-711-0

**QUALITY MANAGEMENT SYSTEM  
CERTIFIED BY DNV  
= ISO/TS 16949 =**

*Microchip received ISO/TS-16949:2009 certification for its worldwide headquarters, design and wafer fabrication facilities in Chandler and Tempe, Arizona; Gresham, Oregon and design centers in California and India. The Company's quality system processes and procedures are for its PIC<sup>®</sup> MCUs and dsPIC<sup>®</sup> DSCs, KEELOQ<sup>®</sup> code hopping devices, Serial EEPROMs, microperipherals, nonvolatile memory and analog products. In addition, Microchip's quality system for the design and manufacture of development systems is ISO 9001:2000 certified.*

**Object of Declaration: MCP19111 Battery Charger Evaluation Board**

EU Declaration of Conformity

Manufacturer: Microchip Technology Inc.  
2355 W. Chandler Blvd.  
Chandler, Arizona, 85224-6199  
USA

This declaration of conformity is issued by the manufacturer.

The development/evaluation tool is designed to be used for research and development in a laboratory environment. This development/evaluation tool is not a Finished Appliance, nor is it intended for incorporation into Finished Appliances that are made commercially available as single functional units to end users under EU EMC Directive 2004/108/EC and as supported by the European Commission's Guide for the EMC Directive 2004/108/EC (8<sup>th</sup> February 2010).

This development/evaluation tool complies with EU RoHS2 Directive 2011/65/EU.

This development/evaluation tool, when incorporating wireless and radio-telecom functionality, is in compliance with the essential requirement and other relevant provisions of the R&TTE Directive 1999/5/EC and the FCC rules as stated in the declaration of conformity provided in the module datasheet and the module product page available at [www.microchip.com](http://www.microchip.com).

For information regarding the exclusive, limited warranties applicable to Microchip products, please see Microchip's standard terms and conditions of sale, which are printed on our sales documentation and available at [www.microchip.com](http://www.microchip.com).

Signed for and on behalf of Microchip Technology Inc. at Chandler, Arizona, USA

  
Derek Carlson  
VP Development Tools

12-Sep-14  
Date



# MCP19111 BATTERY CHARGER EVALUATION BOARD USER'S GUIDE

## Table of Contents

<b>Preface</b> .....	<b>5</b>
Introduction.....	5
Document Layout .....	5
Conventions Used in this Guide .....	6
Recommended Reading.....	7
The Microchip Web Site .....	7
Development Systems Customer Change Notification Service .....	7
Customer Support .....	8
Document Revision History .....	8
<b>Chapter 1. Product Overview</b>	
1.1 Introduction .....	9
1.2 Short Overview: MCP19111 Enhanced Power Analog Controller .....	9
1.3 What Is the MCP19111 Battery Charger Evaluation Board? .....	9
1.4 MCP19111 Battery Charger Evaluation Board Kit Contents .....	10
<b>Chapter 2. Installation and Operation</b>	
2.1 Introduction .....	11
2.2 Getting Started .....	11
<b>Chapter 3. Graphical User Interface</b>	
3.1 Running the MCP19111 Battery Charger Evaluation Board .....	14
3.2 Programming the MCP19111 Battery Charger Evaluation Board .....	24
3.3 Calibration with the GUI .....	26
<b>Appendix A. Schematic and Layouts</b>	
A.1 Introduction .....	30
A.2 Board – Schematic (Sheet 1) .....	31
A.3 Board – Schematic (Sheet 2) .....	32
A.4 Board – Top Silk .....	33
A.5 Board – Top Copper and Silk .....	34
A.6 Board – Top Copper .....	35
A.7 Board – Mid Layer 1 .....	36
A.8 Board – Mid Layer 2 .....	37
A.9 Board – Bottom Silk .....	38
A.10 Board – Bottom Copper and Silk .....	39
A.11 Board – Bottom Copper .....	40
<b>Appendix B. Bill of Materials</b>	
<b>Appendix C. Charge Profile Block Diagrams</b>	
C.1 Introduction .....	43
<b>Worldwide Sales and Service</b> .....	<b>56</b>



# MCP19111 BATTERY CHARGER EVALUATION BOARD USER'S GUIDE

## Preface

### NOTICE TO CUSTOMERS

All documentation becomes dated, and this manual is no exception. Microchip tools and documentation are constantly evolving to meet customer needs, so some actual dialogs and/or tool descriptions may differ from those in this document. Please refer to our web site ([www.microchip.com](http://www.microchip.com)) to obtain the latest documentation available.

Documents are identified with a “DS” number. This number is located on the bottom of each page, in front of the page number. The numbering convention for the DS number is “DSXXXXXXXXA”, where “XXXXXXXX” is the document number and “A” is the revision level of the document.

For the most up-to-date information on development tools, see the MPLAB® IDE on-line help. Select the Help menu, and then Topics to open a list of available on-line help files.

## INTRODUCTION

This chapter contains general information that will be useful to know before using the MCP19111 Battery Charger Evaluation Board. Items discussed in this chapter include:

- Document Layout
- Conventions Used in this Guide
- Recommended Reading
- The Microchip Web Site
- Customer Support
- Document Revision History

## DOCUMENT LAYOUT

This document describes how to use the MCP19111 Battery Charger Evaluation Board as a development tool to emulate and debug firmware on a target board. The manual layout is as follows:

- **Chapter 1. “Product Overview”** – Contains important information on the MCP19111 Battery Charger Evaluation Board
- **Chapter 2. “Installation and Operation”** – Covers the initial setup and operation of the MCP19111 Battery Charger Evaluation Board
- **Chapter 3. “Graphical User Interface”** – Covers the Graphical User Interface (GUI)
- **Appendix A. “Schematic and Layouts”** – Shows the schematic and board layouts for the MCP19111 Battery Charger Evaluation Board
- **Appendix B. “Bill of Materials”** – Lists the parts used to build the MCP19111 Battery Charger Evaluation Board
- **Appendix C. “Charge Profile Block Diagrams”** – Includes block diagrams that show the flow of logic that enables the MCP19111 to control the charge cycle for efficient battery charging

# MCP19111 Battery Charger Evaluation Board User's Guide

## CONVENTIONS USED IN THIS GUIDE

This manual uses the following documentation conventions:

### DOCUMENTATION CONVENTIONS

Description	Represents	Examples
<b>Arial font:</b>		
Italic characters	Referenced books	<i>MPLAB<sup>®</sup> IDE User's Guide</i>
	Emphasized text	...is the <i>only</i> compiler...
Initial caps	A window	the Output window
	A dialog	the Settings dialog
	A menu selection	select Enable Programmer
Quotes	A field name in a window or dialog	"Save project before build"
Underlined, italic text with right angle bracket	A menu path	<u><i>File&gt;Save</i></u>
Bold characters	A dialog button	Click <b>OK</b>
	A tab	Click the <b>Power</b> tab
N'Rnnnn	A number in verilog format, where N is the total number of digits, R is the radix and n is a digit.	4'b0010, 2'hF1
Text in angle brackets < >	A key on the keyboard	Press <Enter>, <F1>
<b>Courier New font:</b>		
Plain Courier New	Sample source code	#define START
	Filenames	autoexec.bat
	File paths	c:\mcc18\h
	Keywords	_asm, _endasm, static
	Command-line options	-Opa+, -Opa-
	Bit values	0, 1
	Constants	0xFF, 'A'
Italic Courier New	A variable argument	<i>file.o</i> , where <i>file</i> can be any valid filename
Square brackets [ ]	Optional arguments	mcc18 [options] <i>file</i> [options]
Curly brackets and pipe character: {   }	Choice of mutually exclusive arguments; an OR selection	errorlevel {0 1}
Ellipses...	Replaces repeated text	var_name [, var_name...]
	Represents code supplied by user	void main (void) { ... }

## RECOMMENDED READING

This user's guide describes how to use MCP19111 Battery Charger Evaluation Board. Other useful documents are listed below. The following Microchip documents are available and recommended as supplemental reference resources.

- **MCP19111 Data Sheet – “Digitally Enhanced Power Analog Controller with Integrated Synchronous Driver” (DS20002331)**
- **MCP19110/11 User’s Guide – “Buck Power Supply Graphical User Interface” (DS50002113B)**

## THE MICROCHIP WEB SITE

Microchip provides online support via our web site at [www.microchip.com](http://www.microchip.com). This web site is used as a means to make files and information easily available to customers. Accessible by using your favorite Internet browser, the web site contains the following information:

- **Product Support** – Data sheets and errata, application notes and sample programs, design resources, user’s guides and hardware support documents, latest software releases and archived software
- **General Technical Support** – Frequently Asked Questions (FAQs), technical support requests, online discussion groups, Microchip consultant program member listing
- **Business of Microchip** – Product selector and ordering guides, latest Microchip press releases, listing of seminars and events, listings of Microchip sales offices, distributors and factory representatives

## DEVELOPMENT SYSTEMS CUSTOMER CHANGE NOTIFICATION SERVICE

Microchip’s customer notification service helps keep customers current on Microchip products. Subscribers will receive e-mail notification whenever there are changes, updates, revisions or errata related to a specified product family or development tool of interest.

To register, access the Microchip web site at [www.microchip.com](http://www.microchip.com), click on Customer Change Notification and follow the registration instructions.

The Development Systems product group categories are:

- **Compilers** – The latest information on Microchip C compilers, assemblers, linkers and other language tools. These include all MPLAB C compilers; all MPLAB assemblers (including MPASM assembler); all MPLAB linkers (including MPLINK object linker); and all MPLAB librarians (including MPLIB object librarian).
- **Emulators** – The latest information on Microchip in-circuit emulators. This includes the MPLAB REAL ICE and MPLAB ICE 2000 in-circuit emulators.
- **In-Circuit Debuggers** – The latest information on the Microchip in-circuit debuggers. This includes MPLAB ICD 3 in-circuit debuggers and PICkit 3 debug express.
- **MPLAB IDE** – The latest information on Microchip MPLAB IDE, the Windows Integrated Development Environment for development systems tools. This list is focused on the MPLAB IDE, MPLAB IDE Project Manager, MPLAB Editor and MPLAB SIM simulator, as well as general editing and debugging features.
- **Programmers** – The latest information on Microchip programmers. These include production programmers such as MPLAB REAL ICE in-circuit emulator, MPLAB ICD 3 in-circuit debugger and MPLAB PM3 device programmers. Also included are nonproduction development programmers such as PICSTART Plus and PICkit 2 and 3.

# MCP19111 Battery Charger Evaluation Board User's Guide

---

---

## CUSTOMER SUPPORT

Users of Microchip products can receive assistance through several channels:

- Distributor or Representative
- Local Sales Office
- Field Application Engineer (FAE)
- Technical Support

Customers should contact their distributor, representative or field application engineer (FAE) for support. Local sales offices are also available to help customers. A listing of sales offices and locations is included in the back of this document.

Technical support is available through the web site at:  
<http://www.microchip.com/support>.

## DOCUMENT REVISION HISTORY

### Revision A (October 2014)

- Initial Release of this Document.





# MCP19111 BATTERY CHARGER EVALUATION BOARD USER'S GUIDE

---

---

## Chapter 1. Product Overview

---

---

### 1.1 INTRODUCTION

This chapter provides an overview of the MCP19111 Battery Charger Evaluation Board and covers the following topics:

- Short Overview: MCP19111 Enhanced Power Analog Controller
- What Is the MCP19111 Battery Charger Evaluation Board?
- MCP19111 Battery Charger Evaluation Board Kit Contents

### 1.2 SHORT OVERVIEW: MCP19111 ENHANCED POWER ANALOG CONTROLLER

The MCP19111 device is a highly-integrated, mixed-signal, analog Pulse-Width Modulation (PWM) current mode controller with an integrated microcontroller core for synchronous DC/DC step-down applications. Since the MCP19111 uses traditional analog control circuitry to regulate the output of the DC/DC converter, the integration of the PIC<sup>®</sup> microcontroller mid-range core is used to provide complete customization of the device operating parameters, start-up and shut-down profiles, protection levels and fault handling procedures.

### 1.3 WHAT IS THE MCP19111 BATTERY CHARGER EVALUATION BOARD?

The MCP19111 Battery Charger Evaluation Board is intended to demonstrate how the MCP19111 device operates in a buck topology for the purpose of charging batteries of various chemistries. It is configured to regulate the amount of charge current and the type of charging while simultaneously reading the state of the battery to change between operation modes for optimized charge profiles. Nearly all operational charge parameters are programmable by utilizing the integrated PIC microcontroller core.

The board comes preprogrammed with firmware designed to operate with the graphical user interface (GUI). MPLAB<sup>®</sup> X Integrated Development Environment (IDE) software can be used to download user-defined firmware, thus tailoring it to the user's specific application. The evaluation board contains headers for In-Circuit Serial Programming<sup>™</sup> (ICSP<sup>™</sup>), as well as I<sup>2</sup>C<sup>™</sup> communication. The MCP19111 Battery Charger Evaluation Board firmware implements an SSP module process derived from the I<sup>2</sup>C specification to allow the MCP19111 to communicate with the GUI via a PICKIT<sup>™</sup> Serial Analyzer. MPLAB X IDE, MPLAB<sup>®</sup> XC8 Compiler toolchain, the MCP19111 Battery Charger Evaluation Board GUI and the MCP19111 Battery Charger Evaluation Board Firmware are available for download from the Microchip website. See [Chapter 3. "Graphical User Interface"](#) for details.

# MCP19111 Battery Charger Evaluation Board User's Guide

## 1.4 MCP19111 BATTERY CHARGER EVALUATION BOARD KIT CONTENTS

The MCP19111 Battery Charger Evaluation Board kit includes the following items:

- MCP19111 Battery Charger Evaluation Board (ADM00513)
- Important Information Sheet

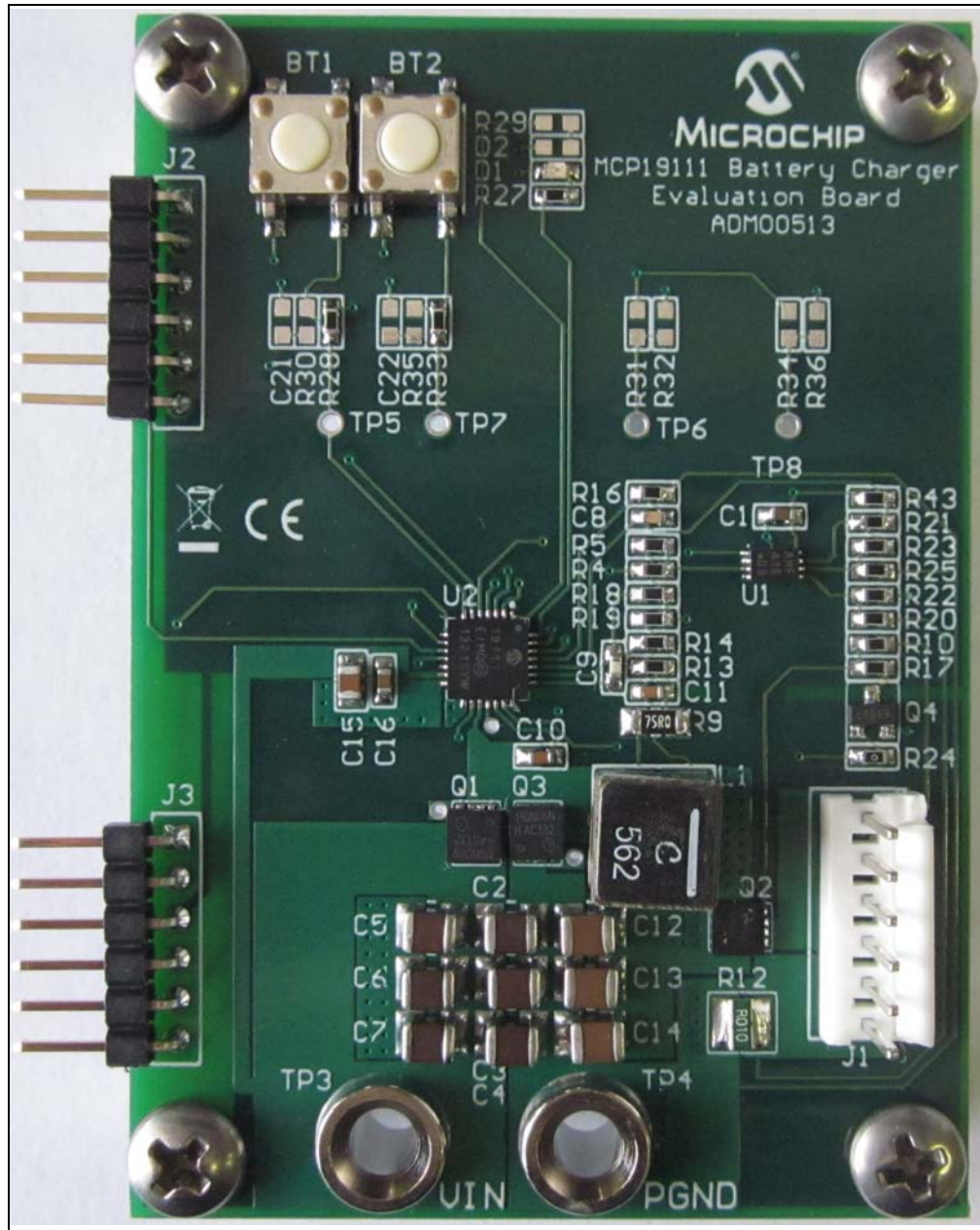

**FIGURE 1-1:** MCP19111 Battery Charger Evaluation Board.



# MCP19111 BATTERY CHARGER EVALUATION BOARD USER'S GUIDE

---

---

## Chapter 2. Installation and Operation

---

---

### 2.1 INTRODUCTION

#### 2.1.1 MCP19111 Battery Charger Evaluation Board Features

The MCP19111 Battery Charger Evaluation Board is used to charge Nickel Metal-Hydrate (NiMH) batteries of up to seven cells, Lithium-Ion (Li-Ion) batteries of up to four cells and Valve-Regulated Lead-Acid (VRLA) batteries of up to six cells. The board uses the MCP19111 digitally-enhanced PWM controller to generate the charge algorithms for the various battery types. The board can run in Rapid Charge Current mode for NiMH batteries, as well as Constant Current/Constant Voltage mode for Li-Ion batteries. The MCP19111 Battery Charger Evaluation Board also has two charge configurations for VRLA batteries, which can be charged in both Rapid Charge and Constant Current modes. The MCP19111 is limited by its input voltage range of 32V.

The MCP19111 Battery Charger Evaluation Board is used to evaluate Microchip's MCP19111 device in a buck power converter topology for a battery-charging application. The MCP19111 device works in conjunction with both current and voltage sense control loops to monitor and regulate the battery pack voltage or charge current. The battery charger board also provides several status and fault indications for various states of the board. Moreover, the board detects the presence or the removal of a battery pack. The board has the capability to connect to both the PICkit™ 3 In-Circuit Debugger/Programmer for reprogramming and the PICkit Serial Analyzer to operate in conjunction with the GUI. Normally, the PICkit Serial Analyzer is used to configure the charge cycle and to change parameters.

The MCP19111 Battery Charger Evaluation Board is fully assembled, programmed and tested to evaluate and demonstrate the MCP19111 operating performance in a digitally-controlled “smart battery-charging” application for various common battery chemistries.

### 2.2 GETTING STARTED

#### 2.2.1 Configuration Requirements

The MCP19111 Battery Charger Evaluation Board GUI requires a computer with Microsoft® Windows® XP/7/8 operating system and a USB 2.0 port. To run the software, follow the steps described in this section.

To power up and run the MCP19111 Battery Charger Evaluation Board with the GUI, the following are required:

- MCP19111 Battery Charger Evaluation Board
- MCP19111 Battery Charger Evaluation Board GUI
- PICkit Serial Analyzer
- Input Power Supply (capable of supplying enough current to support all charge cycles)
- Battery Pack

# MCP19111 Battery Charger Evaluation Board User's Guide

## 2.2.2 Installing the MCP19111 Battery Charger Evaluation Board GUI

Follow the steps below to download and install the MCP19111 Battery Charger Evaluation Board GUI:

1. The MCP19111 Battery Charger Evaluation Board Firmware and GUI archive can be downloaded from the Microchip website at <http://www.microchip.com/wwwproducts/Devices.aspx?product=MCP19111>.
2. After downloading and unzipping the archive, open the GUI folder and locate the `setup.exe` file.
3. Double-click the file. In the Application Install - Security Warning dialog box, press the **Install** button.

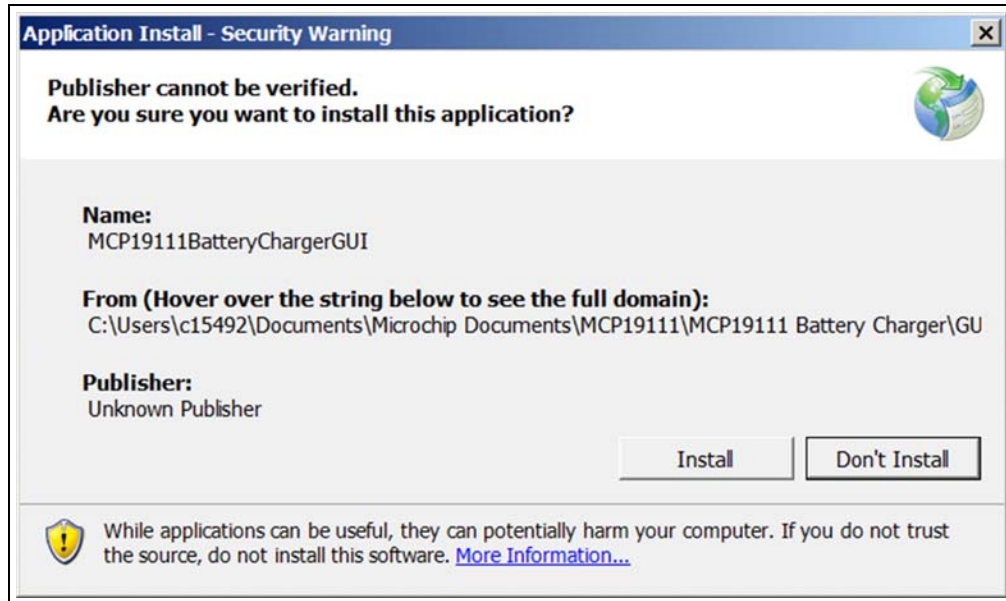

**FIGURE 2-1:** Installing the MCP19111 Battery Charger Evaluation Board GUI.

4. The (100%) Installing MCP19111BatteryChargerGUI window showing the installation progress will appear briefly on the screen.

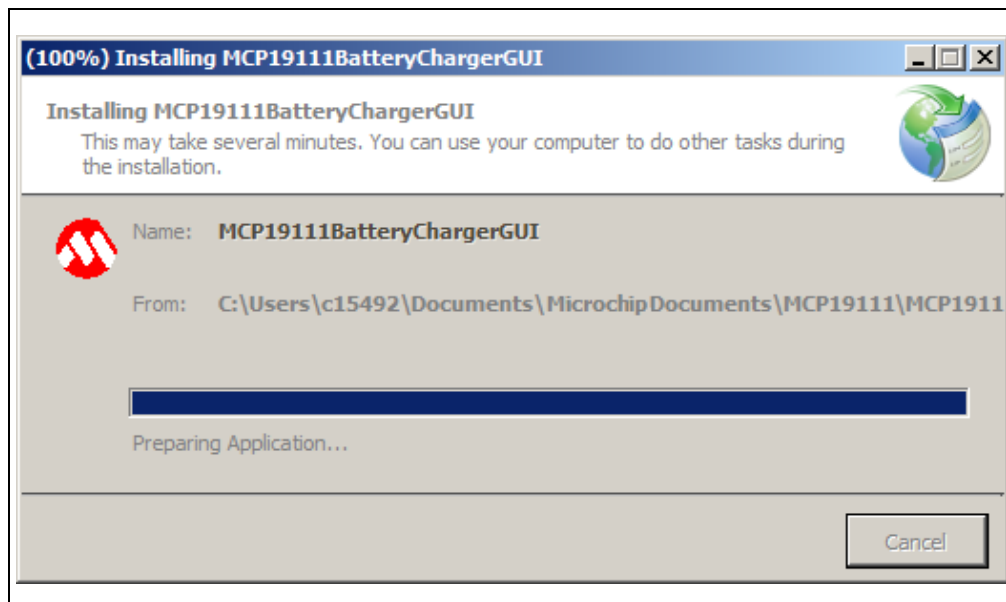

**FIGURE 2-2:** The (100%) Installing MCP19111BatteryChargerGUI Window.

5. Once the installation is complete, the GUI will appear on the screen.

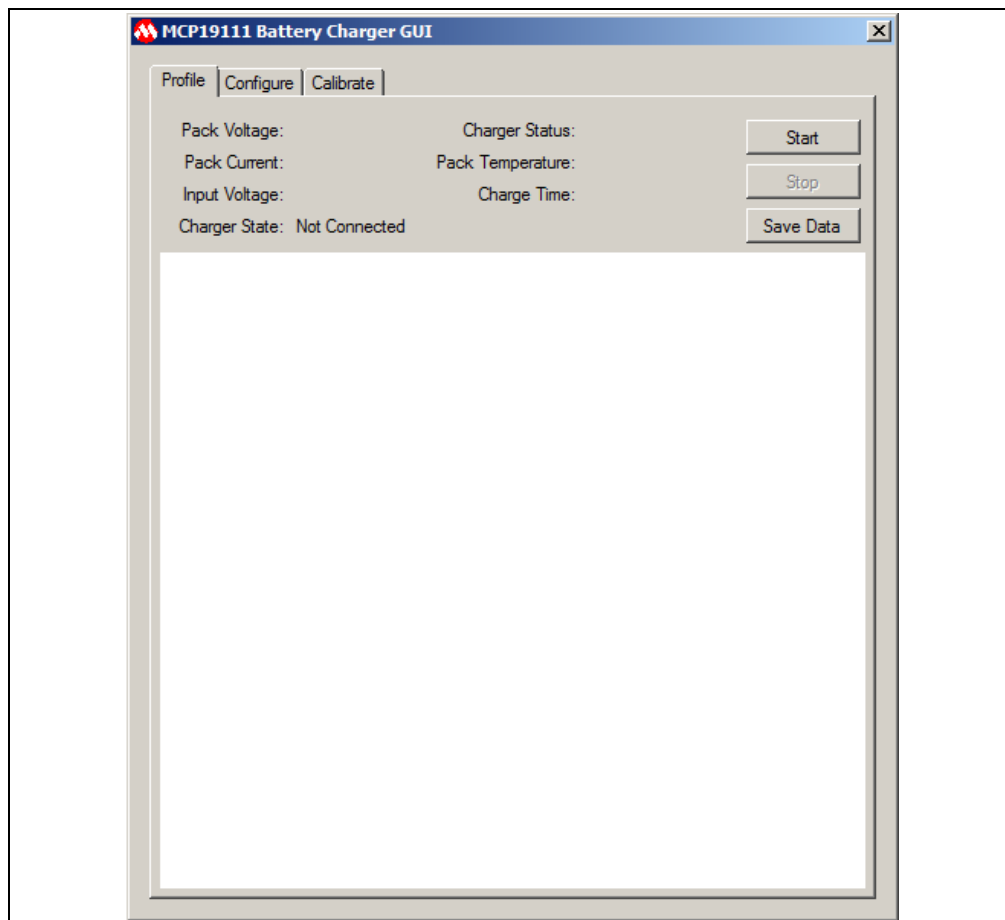

**FIGURE 2-3:** The MCP19111 Battery Charger Evaluation Board GUI.



# MCP19111 BATTERY CHARGER EVALUATION BOARD USER'S GUIDE

---

---

## Chapter 3. Graphical User Interface

---

---

### 3.1 RUNNING THE MCP19111 BATTERY CHARGER EVALUATION BOARD

#### 3.1.1 Setting up the GUI and the Board

1. Connect two banana-banana power cables from the power supply to  $V_{IN}$  and GND jacks on the MCP19111 Battery Charger Evaluation Board. The board should be powered within the range of approximately 13V-28V or  $V_{IN} > V_{OUT} + 2V$ . Different battery chemistries will not start operating until a certain input voltage is reached. However, most types of batteries will charge with an input of 16V to the battery charger board.
2. Connect a battery pack to the J1 header on the evaluation board. Take note of the type of battery, as well as the number of cells and amount of capacity (mAh). These details will become important when running specific charge profiles with the GUI. Ensure the battery is connected to the battery pack properly. The battery pack should have a secure cable to attach to J1 that correctly orients the + lead with pin 1 and 2 of J1 and the - lead with pins 5 and 6 of J1.
3. Attach a PICkit Serial device to J2 on the board and connect to the computer via USB. Ensure the PICkit is powered and not in "busy" status.
4. Make sure the MCP19111 Battery Charger Evaluation Board GUI is installed on the computer. Apply power to the board at a value of  $V_{IN} > V_{OUT} + 2V$  or 6V minimum and open the GUI.

#### 3.1.2 Charge Configuration

1. Once the board is powered and calibrated, select a correct charge configuration based on the type of battery being charged and other factors, such as the rate it needs to be charged at. All these parameters can be changed in the **Configure** tab of the GUI.

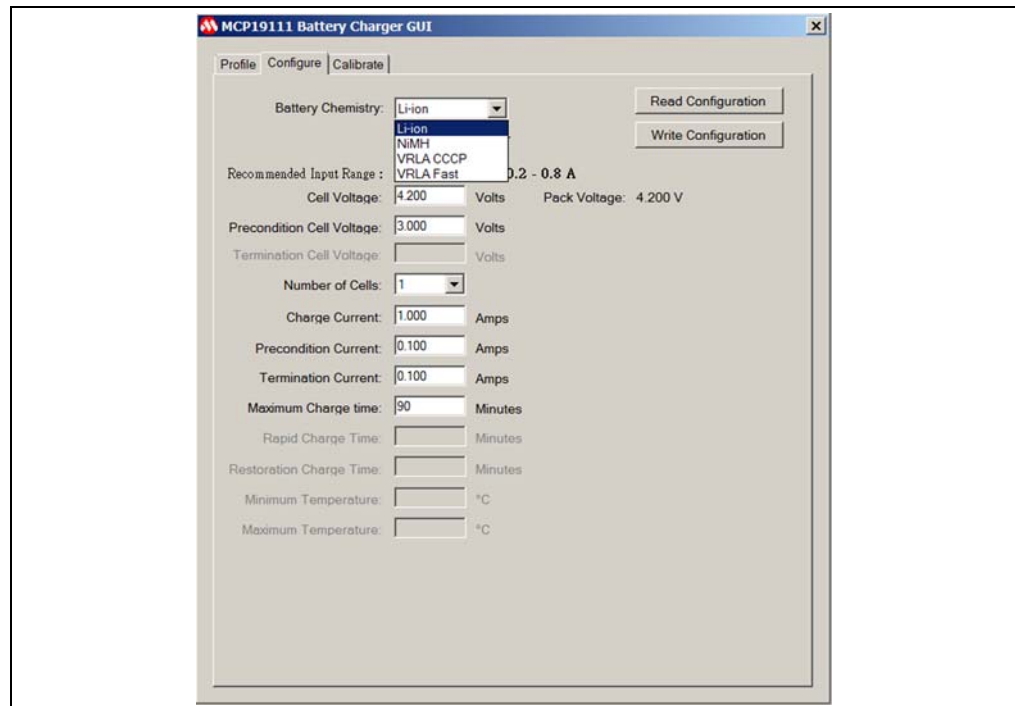

**FIGURE 3-1:** The GUI Configure Tab with Available Battery Chemistries.

# MCP19111 Battery Charger Evaluation Board User's Guide

2. From the Battery Chemistry drop-down menu at the top of the **Configure** tab, the user can select the chemistry of the battery they intend to charge between Lithium ("Li-Ion"), "NiMH", "VRLA CCCP" (Constant Current Constant Potential) and "VRLA Fast" (Rapid Charge Current Mode). The different types of battery chemistries require different charge profiles and selecting any of these lets the GUI provide a preset value for the various charge parameters. It also blocks off certain parameters that can be controlled by the user in order to ensure safe and efficient charging for each type of battery chemistry.
3. The current charge configuration that is set in the firmware of the board can be read into the GUI by selecting the **Read Configuration** button. If a board has not been configured with its current firmware, it will send an error message indicating it does not have a configuration and the user will be required to write one. Refer to the data sheets for the battery pack being used for proper charge parameters to enter into the GUI. When the user has entered the desired parameters into the charge profile, the **Write Configuration** button must be selected to write the profile into the firmware of the MCP19111.
4. If the battery pack has a thermistor, the user can select the "With Thermistor" check box to allow the MCP19111 to read temperature values, which are simultaneously displayed numerically, as well as on a real-time graph in the **Profile** tab so the user can monitor the battery pack temperature.

## 3.1.2.1 CONFIGURATION TAB – OTHER CONFIGURATION PARAMETERS

**TABLE 3-1: OTHER CONFIGURATION PARAMETERS**

Parameter	Description
Cell Voltage	This parameter controls the rated voltage of each cell in the battery pack.
Precondition Cell Voltage	This parameter sets the voltage value at which the battery charger transitions from the precondition current mode to its constant current mode. This transition is meant to protect the battery pack if the value is below the minimum value of the working voltage.
Termination Cell Voltage	This parameter controls the pack voltage value at which the battery charger ends the main charge phase and transitions to the Trickle Charge mode or turns off. This value is typically the maximum value of the specified working voltage range.
Rapid Charge/Charge Current	This parameter provides the current value applied to the battery pack by the charger during the main charging state. The charger implements either Rapid Charge mode or Charge Current mode, depending on the battery chemistry selected.
Restoration/Precondition Current	For deeply discharged batteries, a small amount of restoration current is necessary to bring the battery pack voltage to a level that is safe to implement Rapid Charge Current mode or Charge Current mode. This parameter controls the current value applied during this stage of charging.
Trickle Charge Current	After the battery reaches termination cell voltage, the sudden decrease in current will lead to a drop in the pack voltage. The battery charger applies a trickle charge current controlled by this parameter for an allotted period of time to regulate the voltage at which the main charge cycle terminated.
Termination Current	For Li-Ion and VRLA CCCP chemistries that end their charge cycle in Constant Voltage mode, the termination current parameter controls the current value at which the battery charger will end the charge cycle. The battery charger will slowly ramp down the charge current to this value and then turn off.



**TABLE 3-1: OTHER CONFIGURATION PARAMETERS (CONTINUED)**

<b>Parameter</b>	<b>Description</b>
Number of Cells	Enter the number of cells for the attached battery. The GUI uses this to calculate the termination voltage to charge the battery to. Each battery chemistry allows for certain ranges of cell arrangements.
Rapid Charge Time	This parameter sets the maximum time period during which the battery charger will run in Rapid Charge mode.
Restoration Charge Time	This parameter sets the maximum time period during which the battery charger will apply restoration current to the battery.
Maximum Temperature	A protection feature for the battery that is only active when the “With Thermistor” check box is selected with a NiMH charge profile. The parameter sets the maximum temperature in degrees Celsius (°C) that the battery can reach before the battery charger shuts off completely.
Minimum Temperature	A protection feature for the battery that is only active when the “With Thermistor” check box is selected. The parameter sets the minimum temperature in degrees Celsius (°C) that the battery can fall down to before the battery charger shuts off completely.

## 3.1.3 Running a Charge Profile

Once the user has ensured the battery charger board is powered, programmed, calibrated and configured properly, a charge profile can be defined. By selecting the **Profile** tab, the user can control running the charge profile and monitoring the charge status. At the top of the tab, the user can view the instantaneous values of the pack voltage, pack current, input voltage and state of the charger.

At all times, the user can see whether the battery pack is charging or not. The battery charger board will also give error states such as Overtemperature (OT), Under Threshold Input Voltage (UT) or Over Threshold Input Voltage (OVT). The charger will say "Off" if the user attempts to run a charge but the charger board is not currently running.

**Note:** The MCP19111 Battery Charger Evaluation Board is shipped already programmed and calibrated. Unless the user programs it themselves or adjusts the calibration data, the Charge Configuration is the only necessary user input.

When the battery is successfully charging, the Charger State will read different states based on the type of battery that is being charged. Examples of different charge states include "Precondition", "Constant Current", "Constant Voltage", "Rapid Charge", "Trickle" and "Off".

Enabling the charge can be toggled by selecting the **Start** and **Stop** buttons. The graphs on the lower half of the tab display real-time voltage and current, as well as a temperature profile if the "With Thermistor" check box was selected in the **Configure** tab. The GUI allows for the reporting of the various measured values in real time, so that the user can monitor if charge current and voltage are regulating correctly and safely.

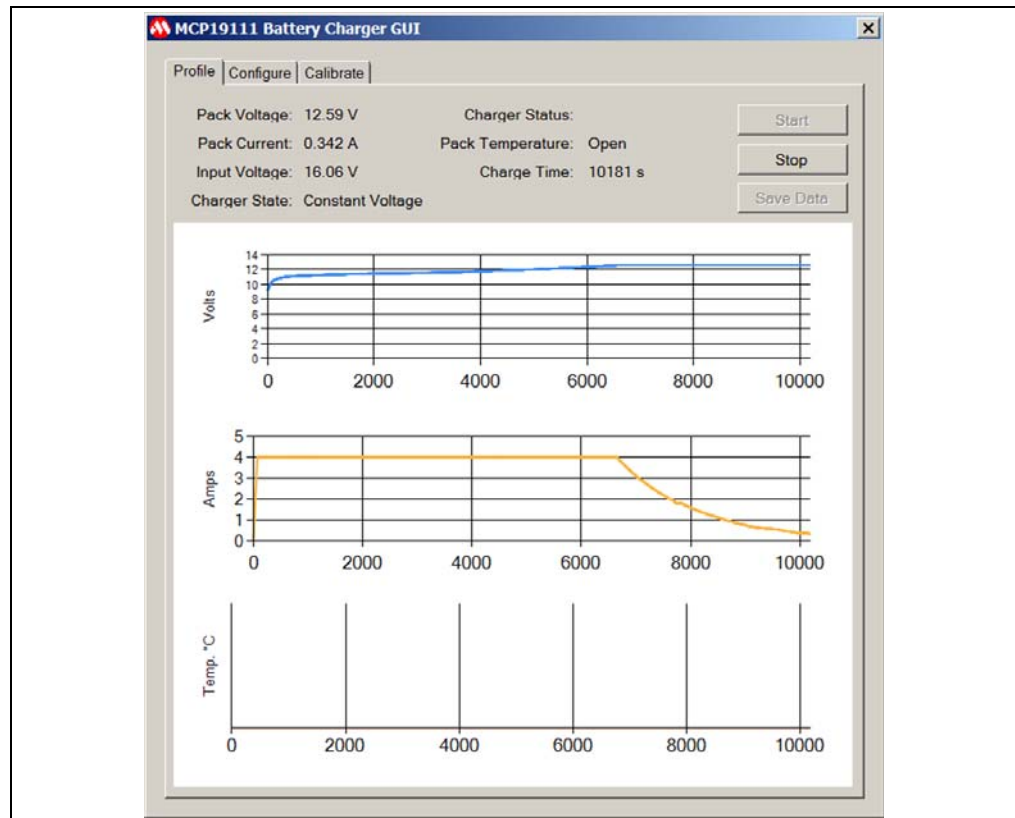

**FIGURE 3-2:** A Full Charge Profile.

**TABLE 3-2: CHARGE CURRENT LIMITATIONS**

Minimum	Maximum
0.10A	6.00A

# MCP19111 Battery Charger Evaluation Board User's Guide

## 3.1.4 Battery Chemistry Charge Profiles

Figures 3-3 to 3-6 show examples of curves in the charge profiles.

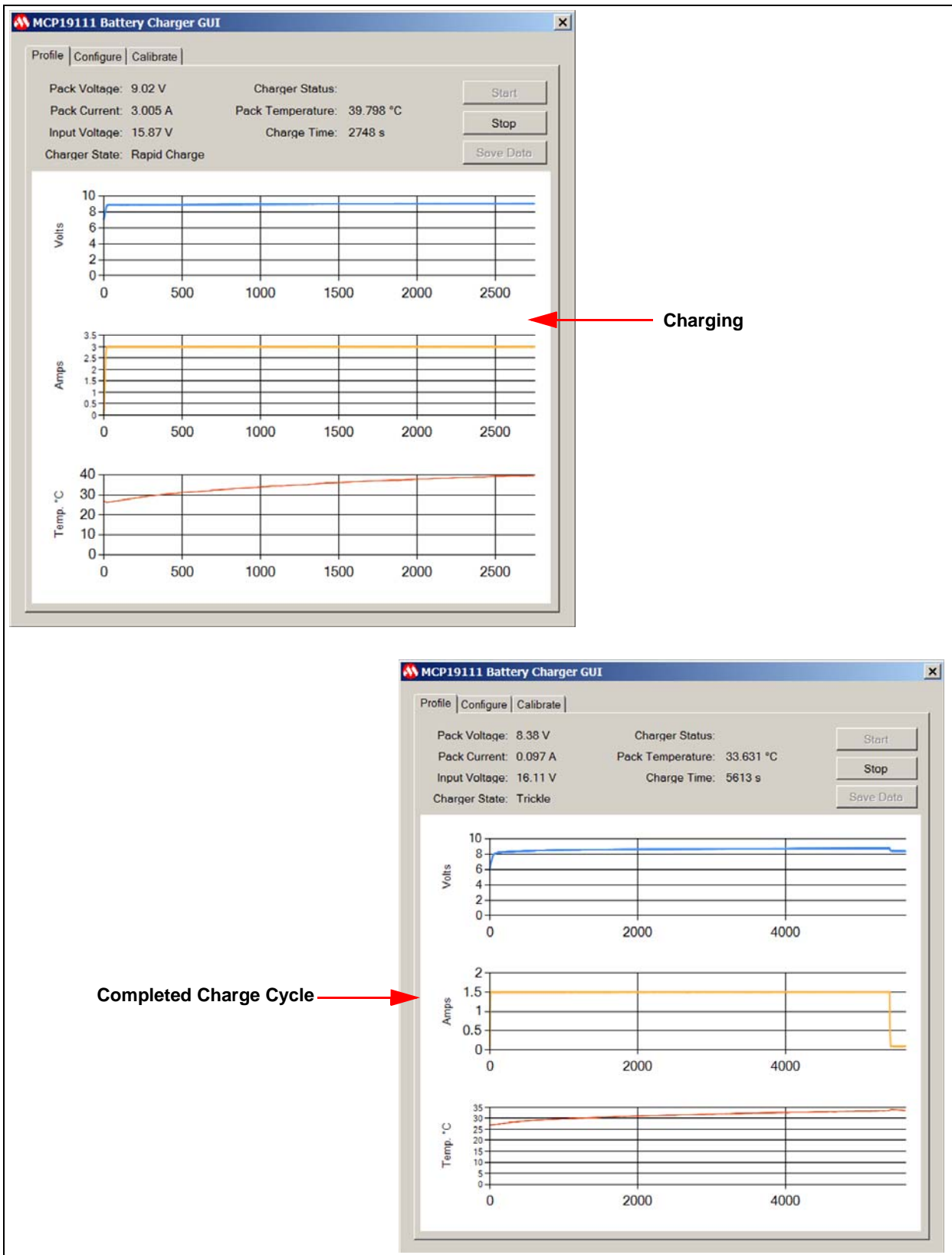

**FIGURE 3-3:** Charge Profile for NiMH Battery Pack (6-Cell, 3.00A Charge Current).

# Graphical User Interface

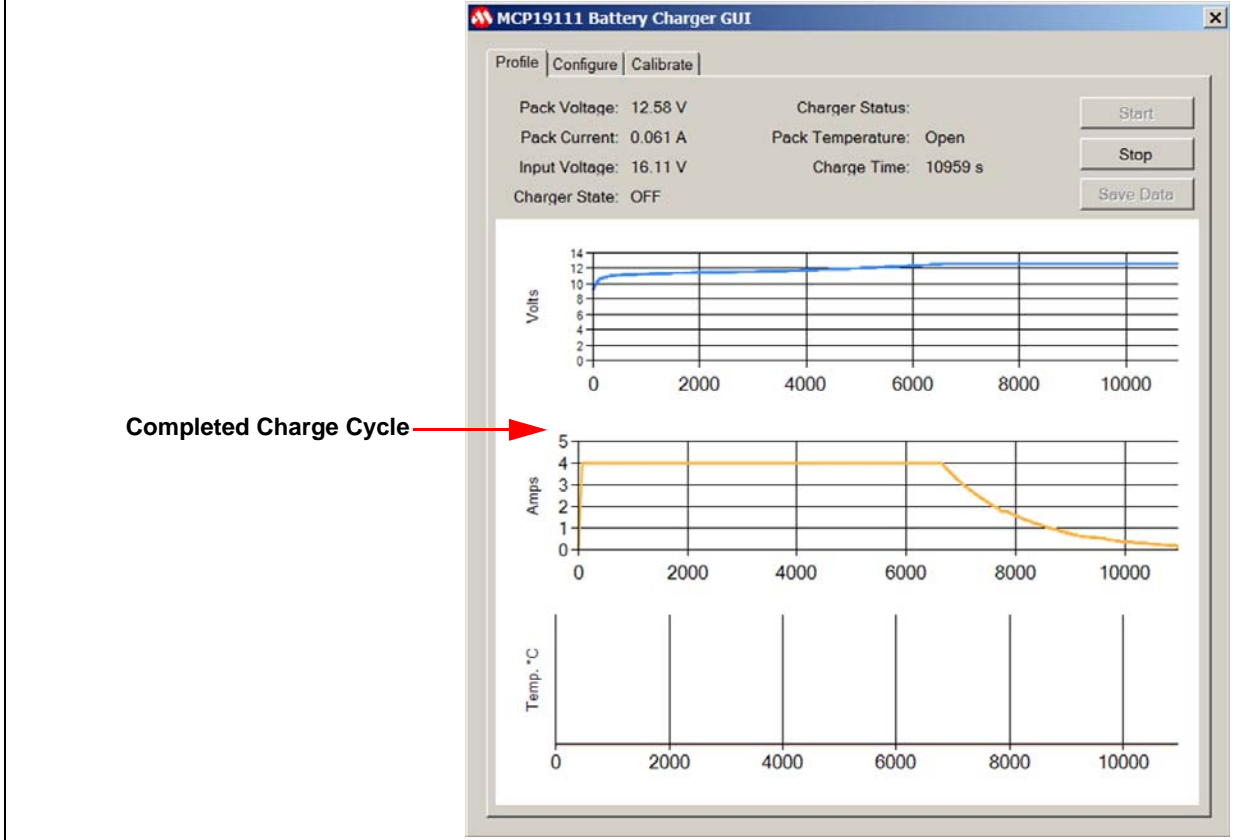
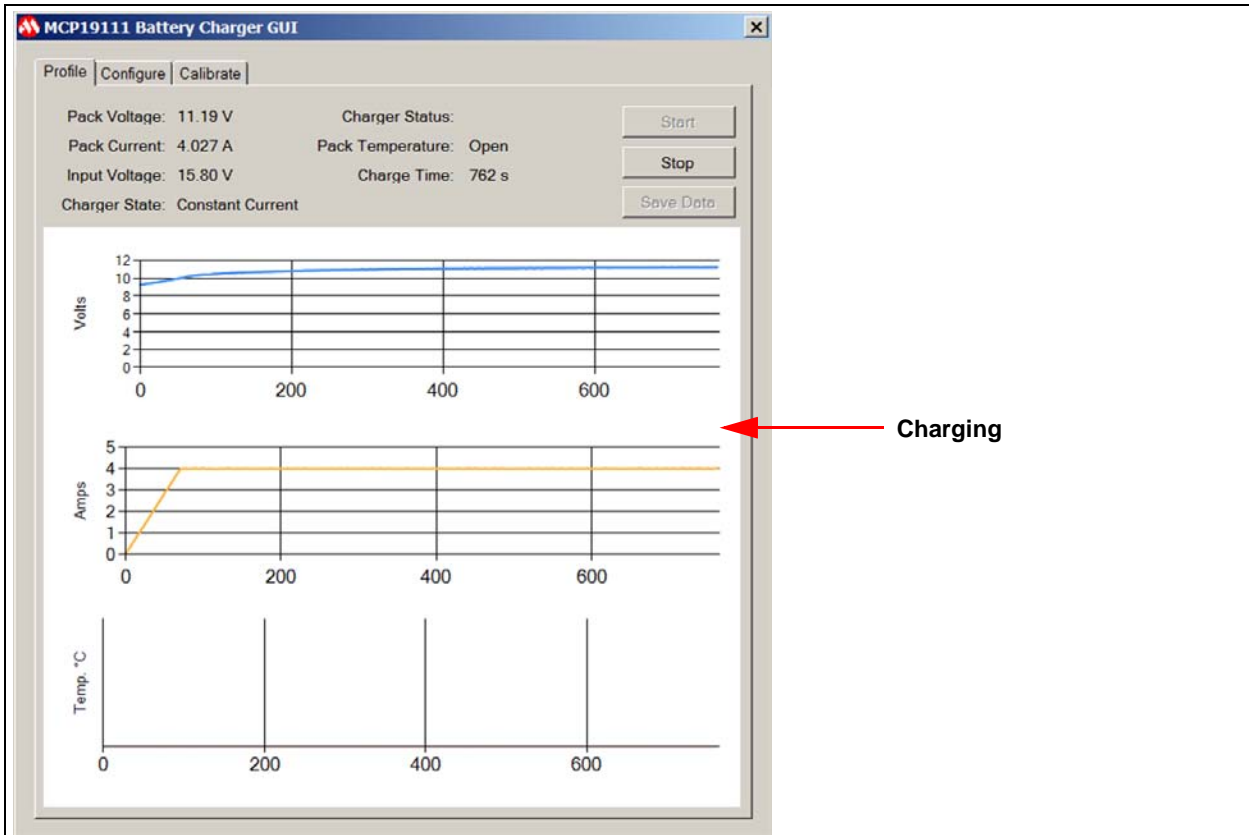

**FIGURE 3-4:** Charge Profile for Li-Ion Battery Pack (3-Cell, 4.00A Charge Current).

# MCP19111 Battery Charger Evaluation Board User's Guide

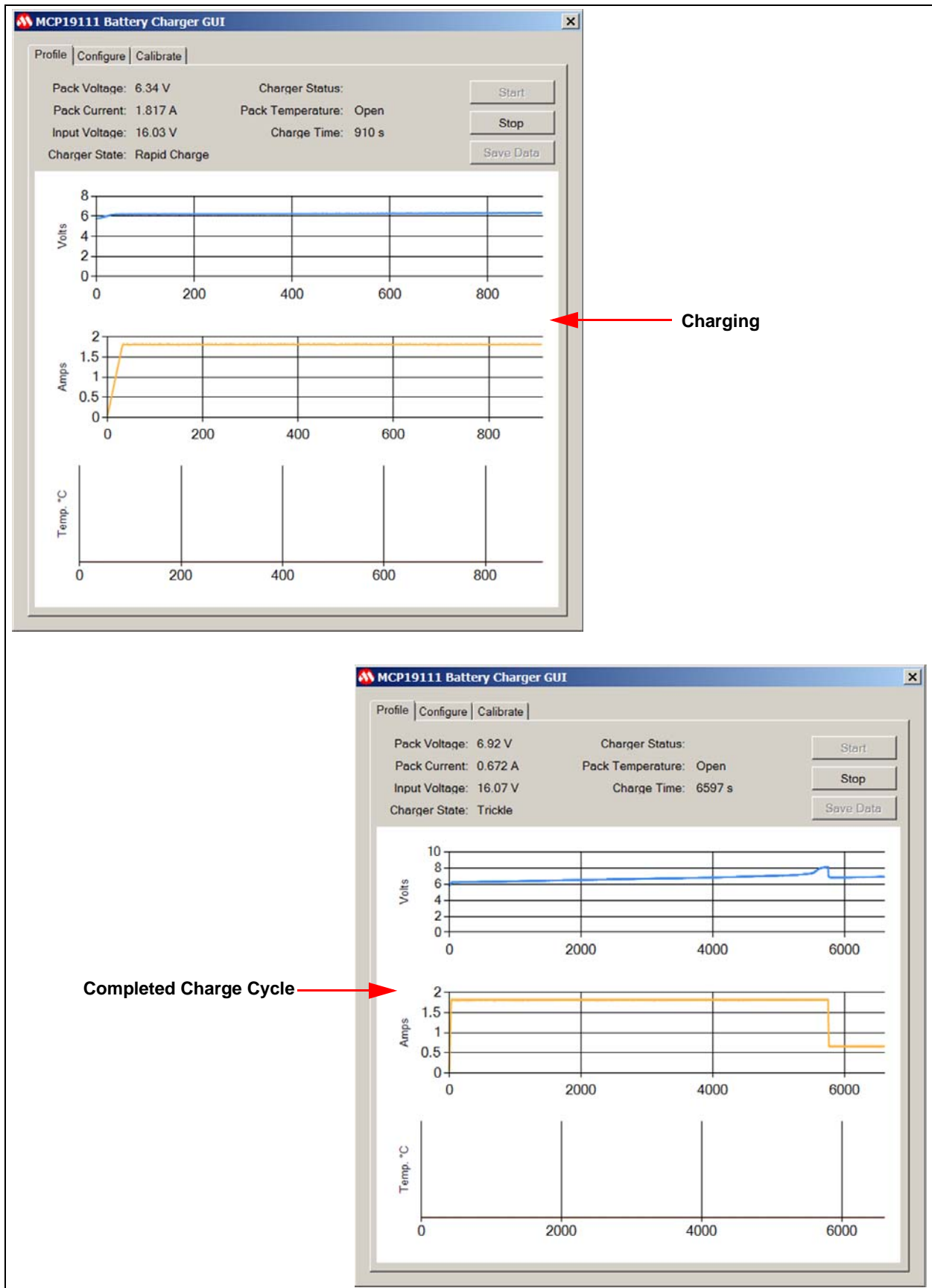

**FIGURE 3-5:** VRLA Fast Charge Profile (3-Cell, 1.80A Charge Current).

# Graphical User Interface

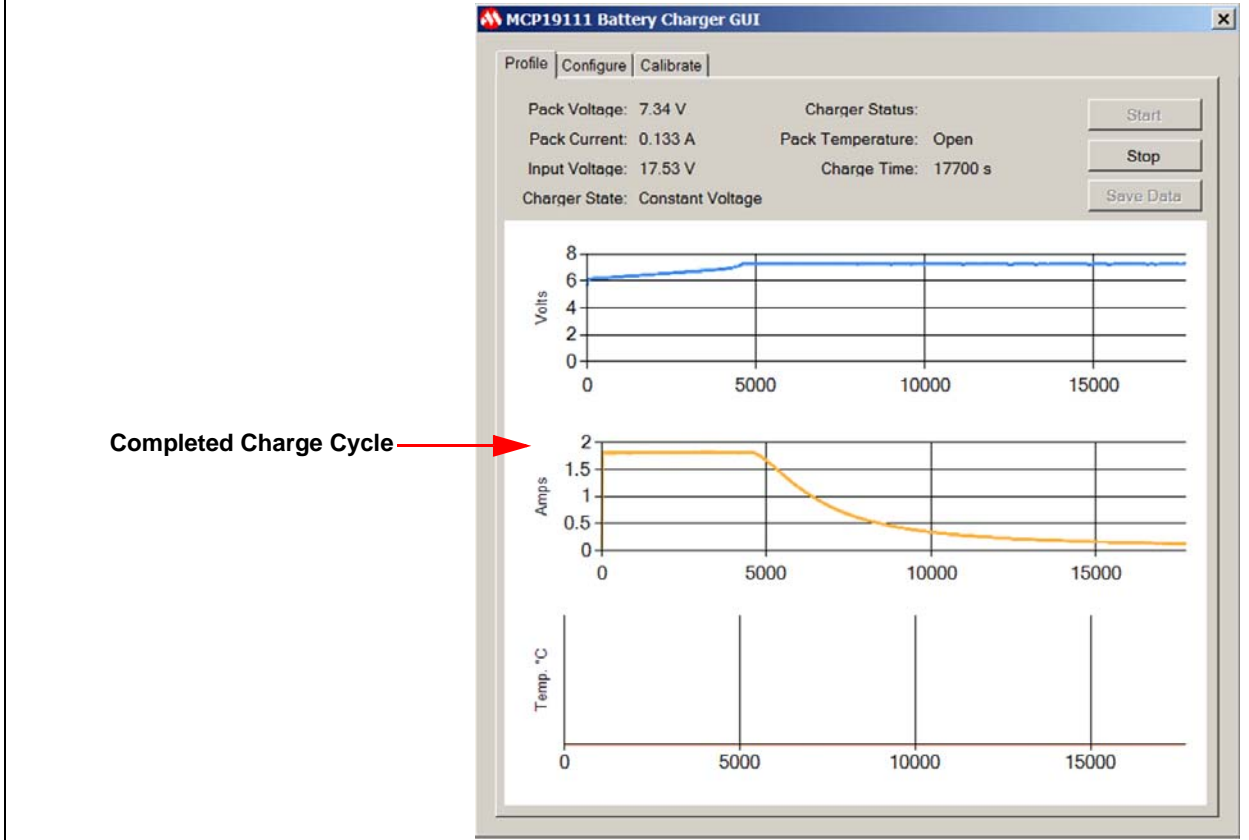
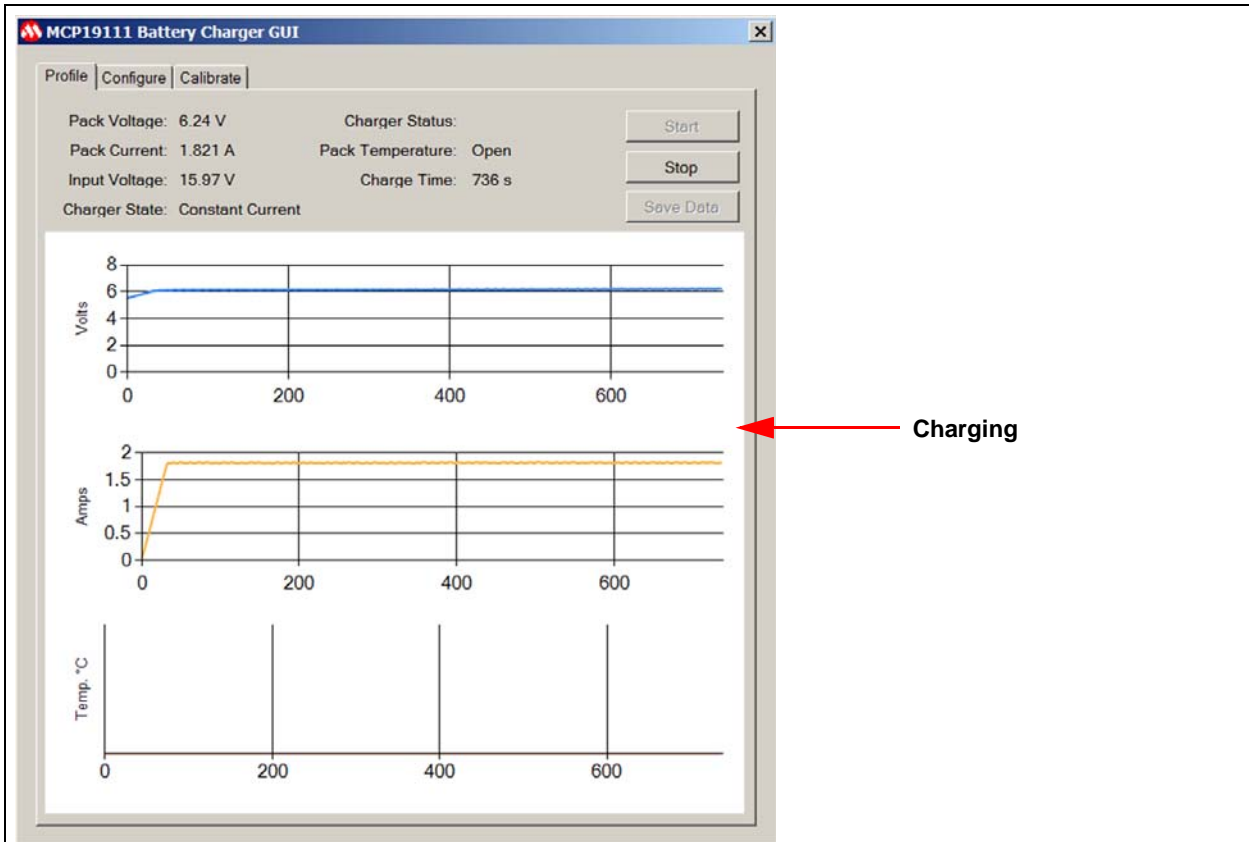

**FIGURE 3-6:** VRLA CCCP Charge Profile (3-Cell, 1.80A Charge Current).

# MCP19111 Battery Charger Evaluation Board User's Guide

## 3.2 PROGRAMMING THE MCP19111 BATTERY CHARGER EVALUATION BOARD

The MCP19111 Battery Charger Evaluation Board comes with preprogrammed firmware installed. The following tools are required to reprogram the device.

- MPLAB X Integrated Development System (IDE) (version 2.05 or later)
- MPLAB XC8 Compiler (version 1.3 or later)
- MCP19111 Battery Charger Evaluation Board Firmware
- MCP19111 Battery Charger Evaluation Board
- PICKit 3 In-Circuit Debugger/Programmer

Follow the steps below to install all necessary software and start reprogramming the MCP19111 device:

1. If MPLAB X IDE is already installed, go to Step 2. If not, download MPLAB X IDE from [www.microchip.com/mplabx](http://www.microchip.com/mplabx) and follow the MPLAB X IDE installation instructions.
2. If an XC8-compatible C-compiler or an equivalent is already installed in MPLAB X IDE, go to Step 3. If not, a free version of Microchip's XC8 is available for download on [www.microchip.com/mplabxc](http://www.microchip.com/mplabxc). The XC8 user guide, installation instructions and download links are available on this page.
3. Download the MCP19111 Battery Charger Evaluation Board Firmware archive (\*.zip) from [www.microchip.com/mcp19111](http://www.microchip.com/mcp19111) under "Documentation & Software".
4. Unzip the MCP19111 Battery Charger Evaluation Board Firmware archive. Place the MCP19111BatteryCharger.X project folder in the desired folder location.
5. Power up the MCP19111 Battery Charger Evaluation Board.
6. Connect the PICKit 3 In-Circuit Debugger to the MCP19111 Battery Charger Evaluation Board via the 6-pin connector J3.
7. Open MPLAB X IDE to load the MCP19111 Battery Charger Evaluation Board Firmware. From the File menu, select Open Project (Figure 3-7).

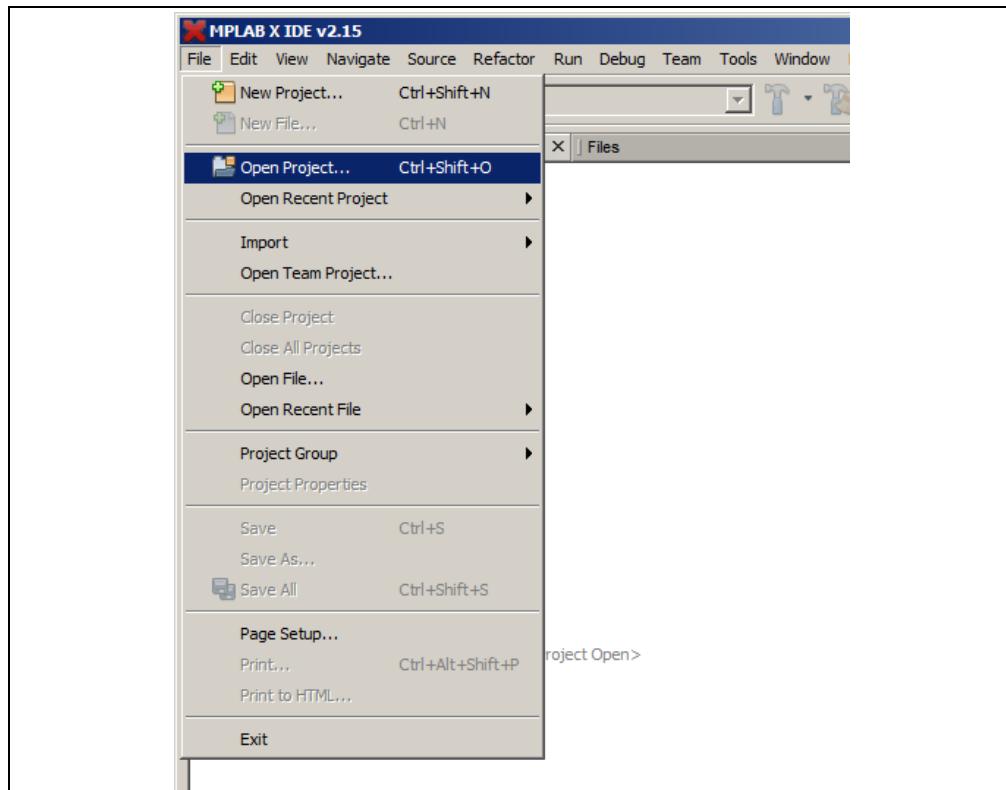

**FIGURE 3-7:** Opening Project in MPLAB X IDE.



- Browse for the location of the extracted firmware. Select “MCP19111BatteryCharger.X” from the list, then check the “Open as Main Project” option. Click on the **Open Project** button to complete loading the file.

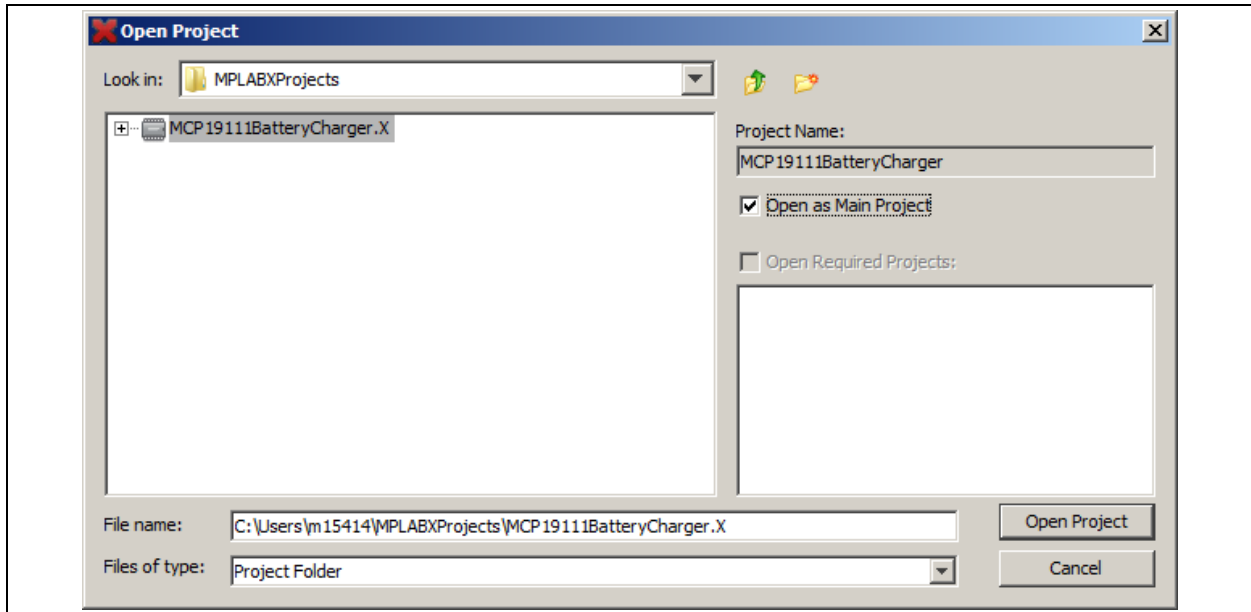

**FIGURE 3-8:** Loading Firmware into MPLAB X IDE.

- Once the project is opened, click on the **Make and Program Device Main Project** (🔧) button on the tool bar to program the device. Wait until the program process is complete, as shown in [Figure 3-9](#).

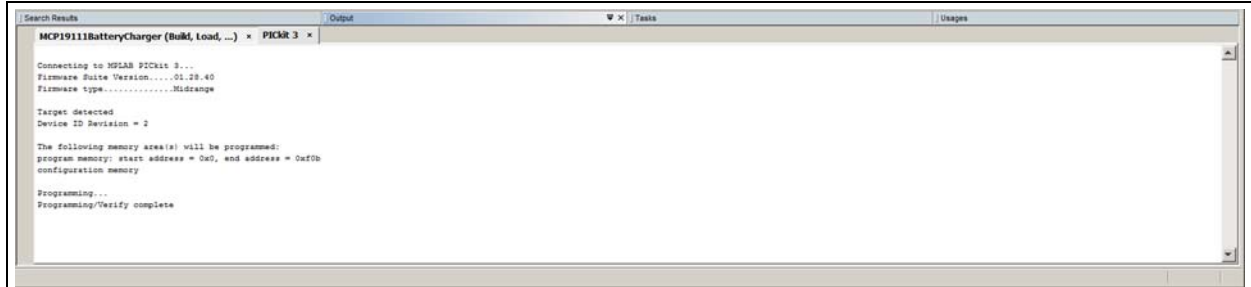

**FIGURE 3-9:** Program Process Complete Window.

# MCP19111 Battery Charger Evaluation Board User's Guide

## 3.3 CALIBRATION WITH THE GUI

The evaluation board is calibrated prior to distribution. If calibration is lost as a result of programming follow this procedure to recalibrate.

To calibrate the MCP19111 Battery Charger Evaluation Board, the following is required:

- MCP19111 Battery Charger Evaluation Board
- MCP19111 Battery Charger Evaluation Board GUI
- PICKit Serial Analyzer
- Two variable power supplies (0-32V, 0-3.5A)
- Two Banana-Banana Power Cables
- Two Banana-Grabber Power Cables
- Digital Multimeter

To complete board calibration, follow the steps below:

1. Make sure the MCP19111 Battery Charger Evaluation Board is programmed with the most up-to-date firmware. Connect the  $V_{IN}$  and  $P_{GND}$  terminals of the battery charger board to a variable power supply and apply 8.40V.
2. Run a banana-grabber cable from  $V_{IN}$  to pin 1 or 2 of J1. This is to emulate the battery pack voltage that is read by the MCP19111 and displayed in the GUI for calibration.
3. Run a second banana-grabber cable from the ground terminal to pin 5 or 6 of J1. This provides a direct reference to ground.
4. Attach a multimeter to the same respective pins in order to accurately measure the simulated battery voltage. Make sure the voltage read is 8.40V. Refer to [Figure 3-10](#) for the proper voltage calibration setup.

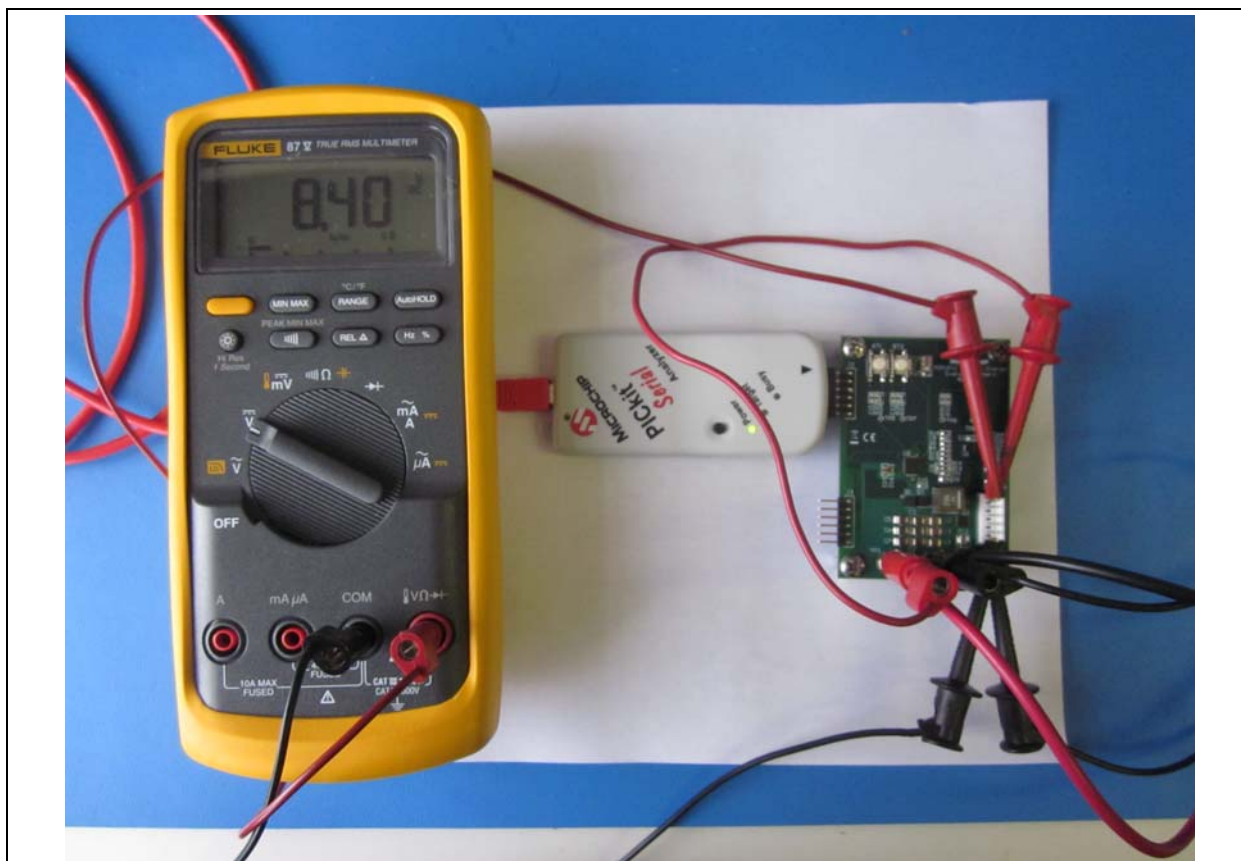

**FIGURE 3-10:** Voltage Calibration Setup.

5. Make sure the GUI is installed on a computer. Connection from the GUI to the board can be made using a PICKit Serial Analyzer. Attach the PICKit Serial to J2 on the board and connect to the computer hosting the GUI via USB. The LEDs of the PICKit should be visible when looking at the front of the board. Make sure that the <Power> LED on the PICKit Serial is on and the <Busy> LED is not flashing red.
6. In the GUI, select the **Calibrate** tab (see [Figure 3-11](#)). This tab contains boxes to read values into the ADC of the MCP19111 to initialize and calibrate the firmware for the specific evaluation board that has been attached.

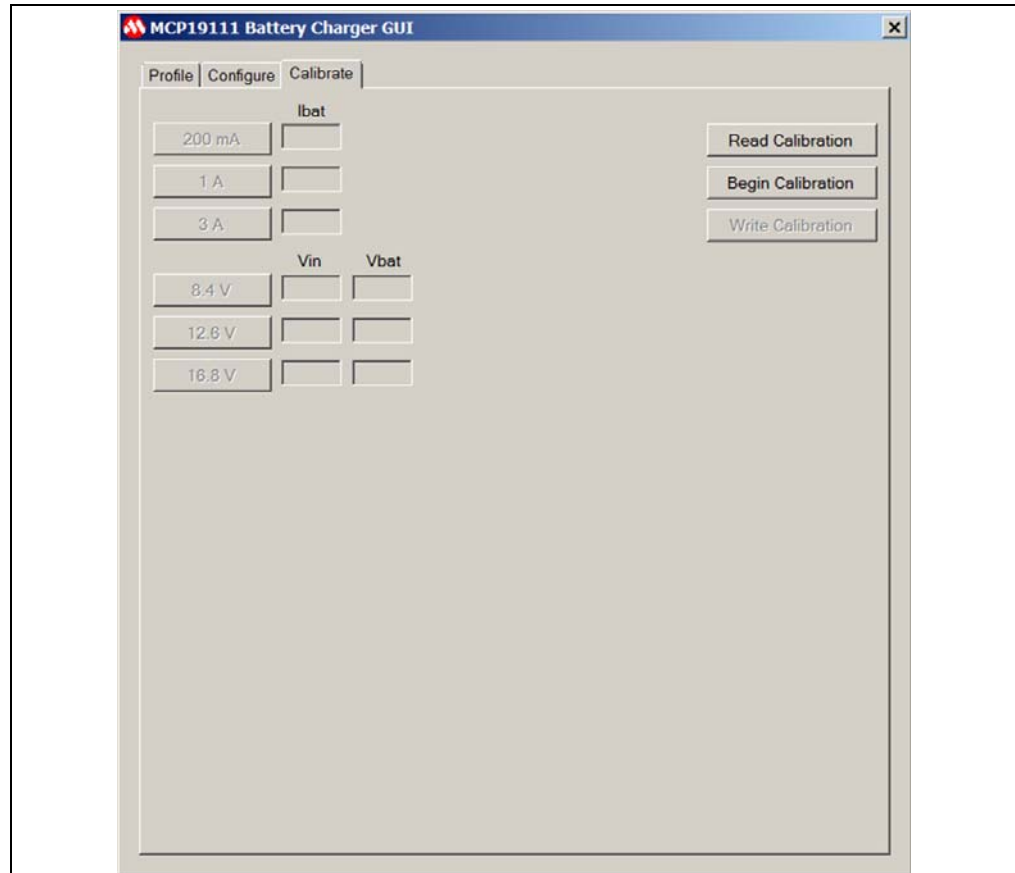
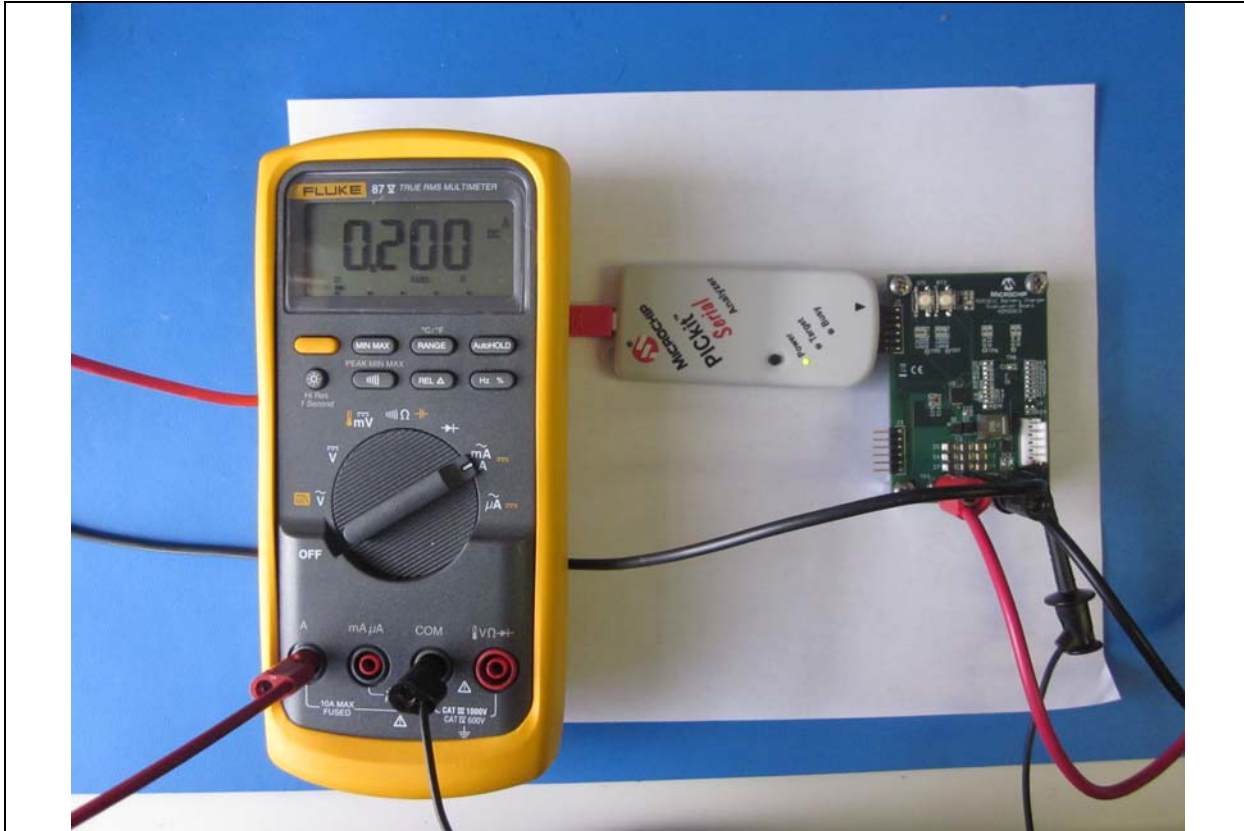

**FIGURE 3-11:** The Calibrate Tab.

7. Click on the **Begin Calibration** button to enable the remaining fields on the tab. Confirm that the pack voltage being read is 8.40V with a multimeter and then click on the button with the corresponding value. This stores calibration values to the firmware to accommodate to that specific board. Repeat for 12.60V and 16.80V.
8. To calibrate the board for pack current, a slightly different configuration is needed. Disconnect the multimeter and connections from the J1 header.

# MCP19111 Battery Charger Evaluation Board User's Guide

- An additional power supply will be needed to provide constant current values to the battery charger board. To ensure accurate calibration, input current should be run through a digital ammeter to display correct current values. This current should be connected to pin 5 or 6 of J1. To complete the current loop, connect P<sub>GND</sub> to the ground terminal of the constant current power supply, so that both supplies share the same ground reference. Refer to for a correct configuration of the current calibration setup.



**FIGURE 3-12:** Current Calibration Setup.

- Run the constant current supply at 200 mA, 1.00A and 3.00A, while ensuring the values are exact with the digital ammeter. Select the respective buttons with each current value after verifying accurate measurement to read the calibration value. When all values have been collected, click on the **Write Calibration** button. This stores the calibration values to the firmware of the MCP19111 device on the board. [Figure 3-13](#) provides an example of proper calibration values.

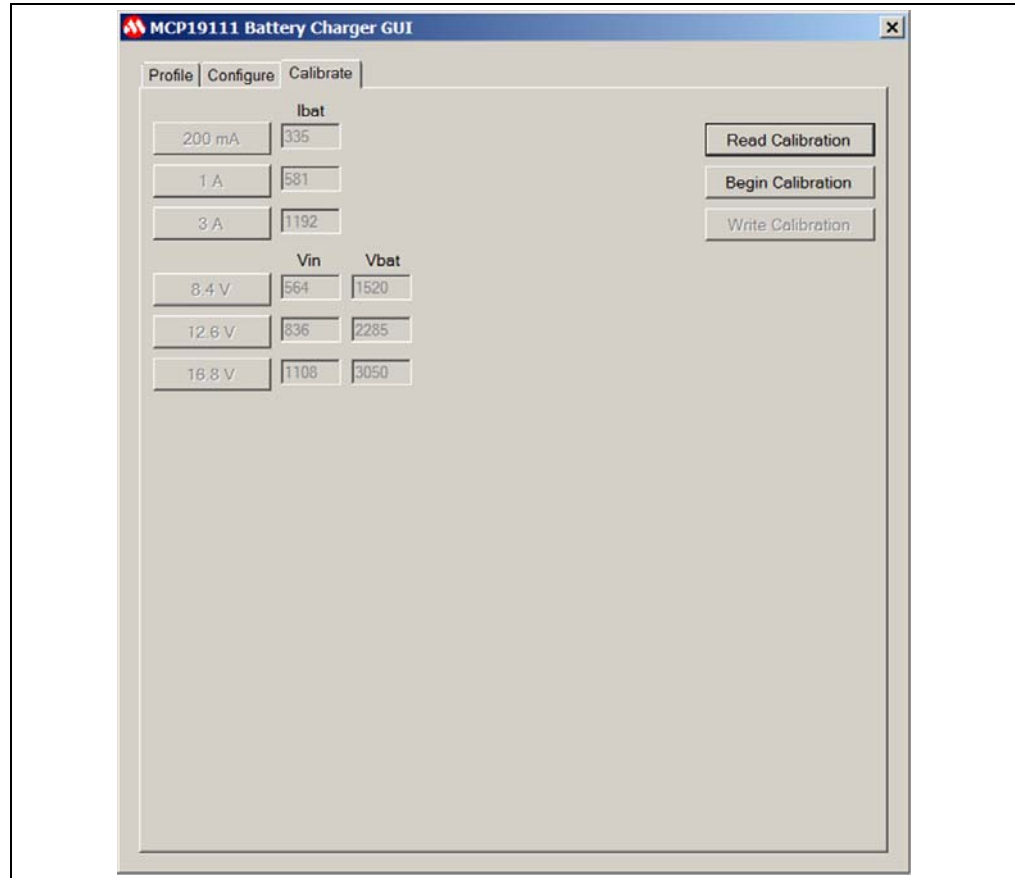

**FIGURE 3-13:** GUI Calibration Tab with Proper Calibration Values.

- To verify whether a board is properly calibrated, click on the **Read Calibration** button while the board is powered and connected to the GUI.
- Error checking is performed during the calibration process. In case of an error message, recheck connections and restart the calibration process.



# MCP19111 BATTERY CHARGER EVALUATION BOARD USER'S GUIDE

---

---

## Appendix A. Schematic and Layouts

---

---

### A.1 INTRODUCTION

This appendix contains the following schematics and layouts for the MCP19111 Battery Charger Evaluation Board:

- Board – Schematic (Sheet 1)
- Board – Schematic (Sheet 2)
- Board – Top Silk
- Board – Top Copper and Silk
- Board – Top Copper
- Board – Mid Layer 1
- Board – Mid Layer 2
- Board – Bottom Silk
- Board – Bottom Copper and Silk
- Board – Bottom Copper

A.2 BOARD – SCHEMATIC (SHEET 1)

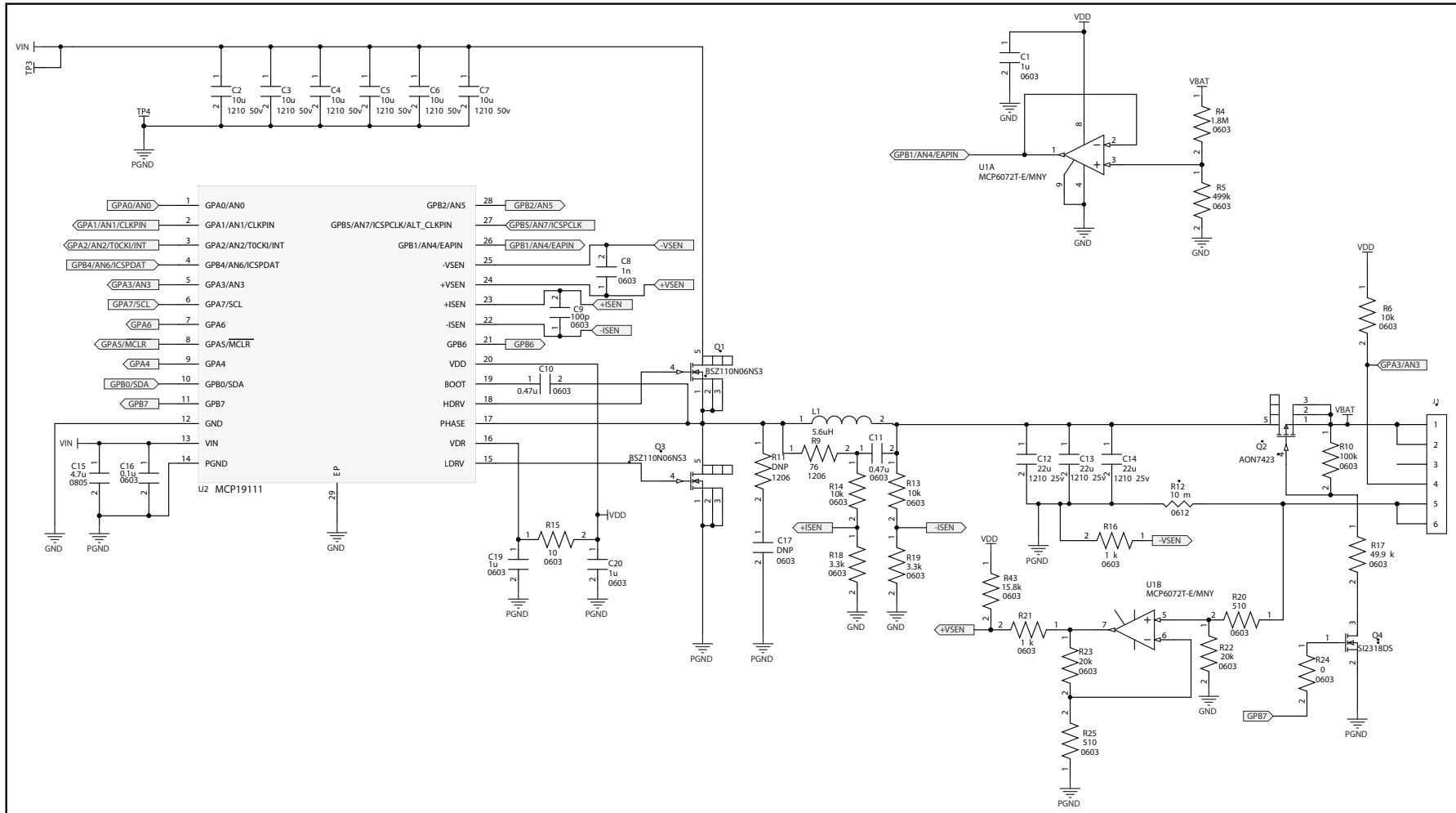

### A.3 BOARD – SCHEMATIC (SHEET 2)

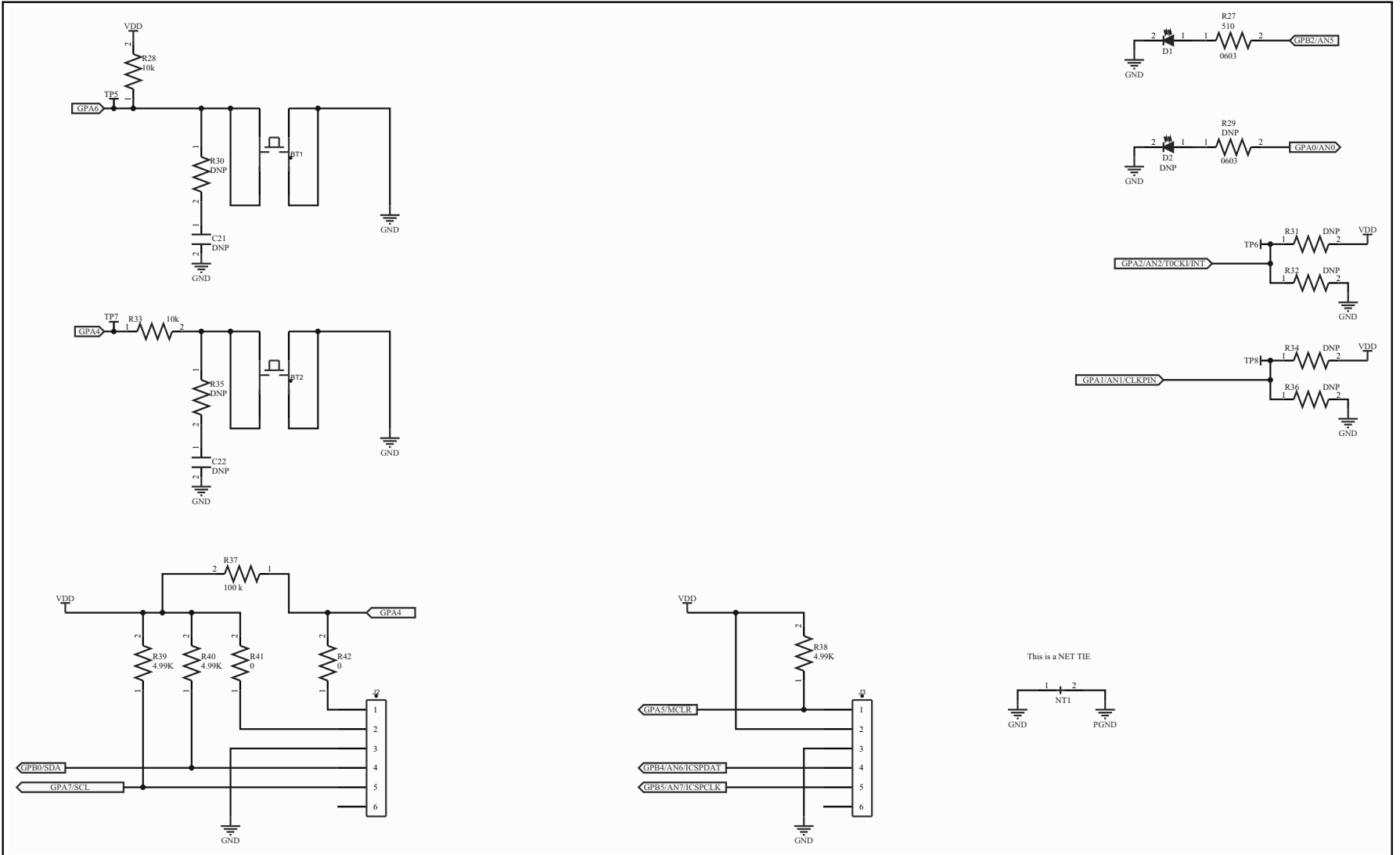



## A.4 BOARD – TOP SILK

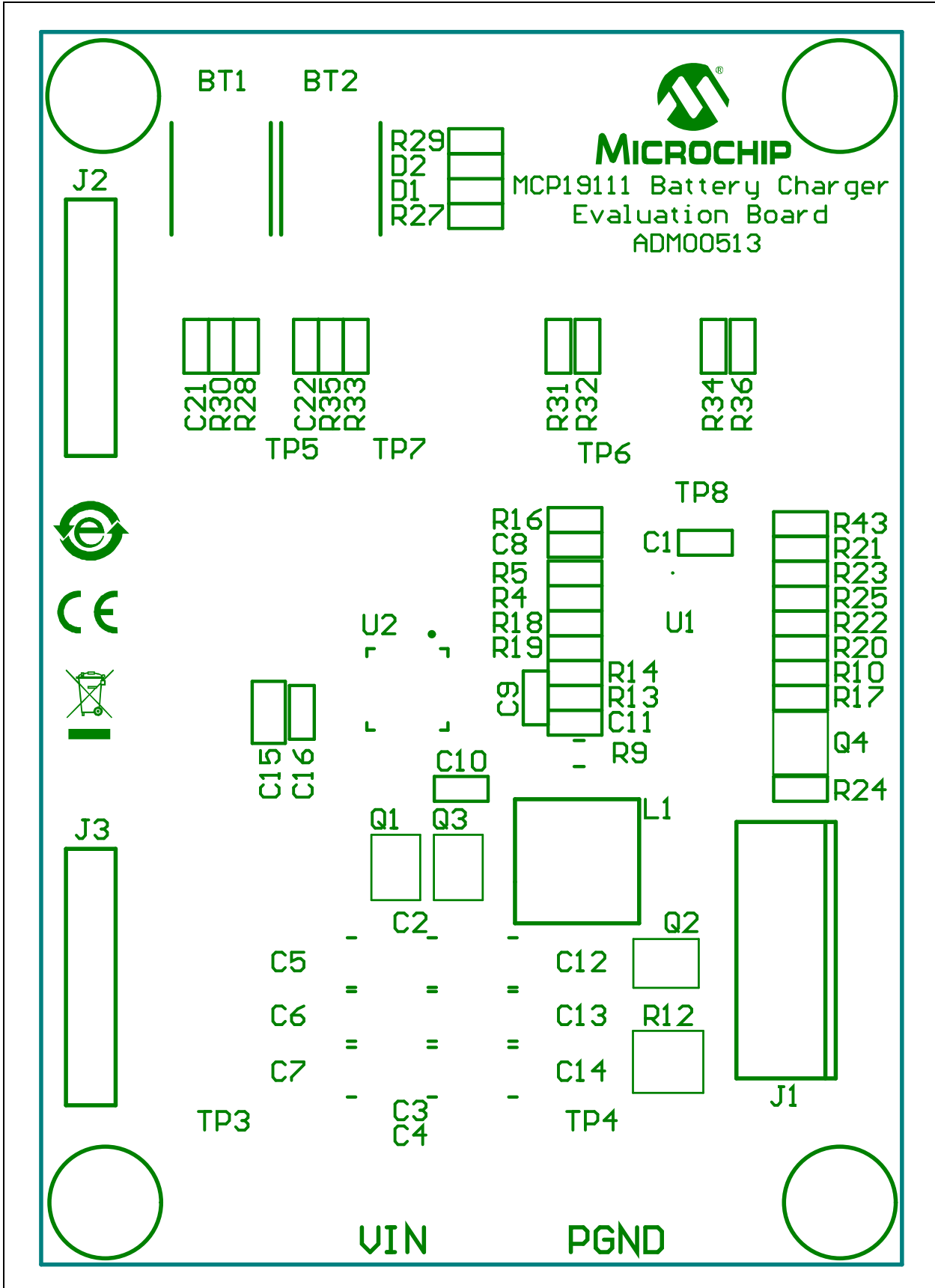

# MCP19111 Battery Charger Evaluation Board User's Guide

## A.5 BOARD – TOP COPPER AND SILK

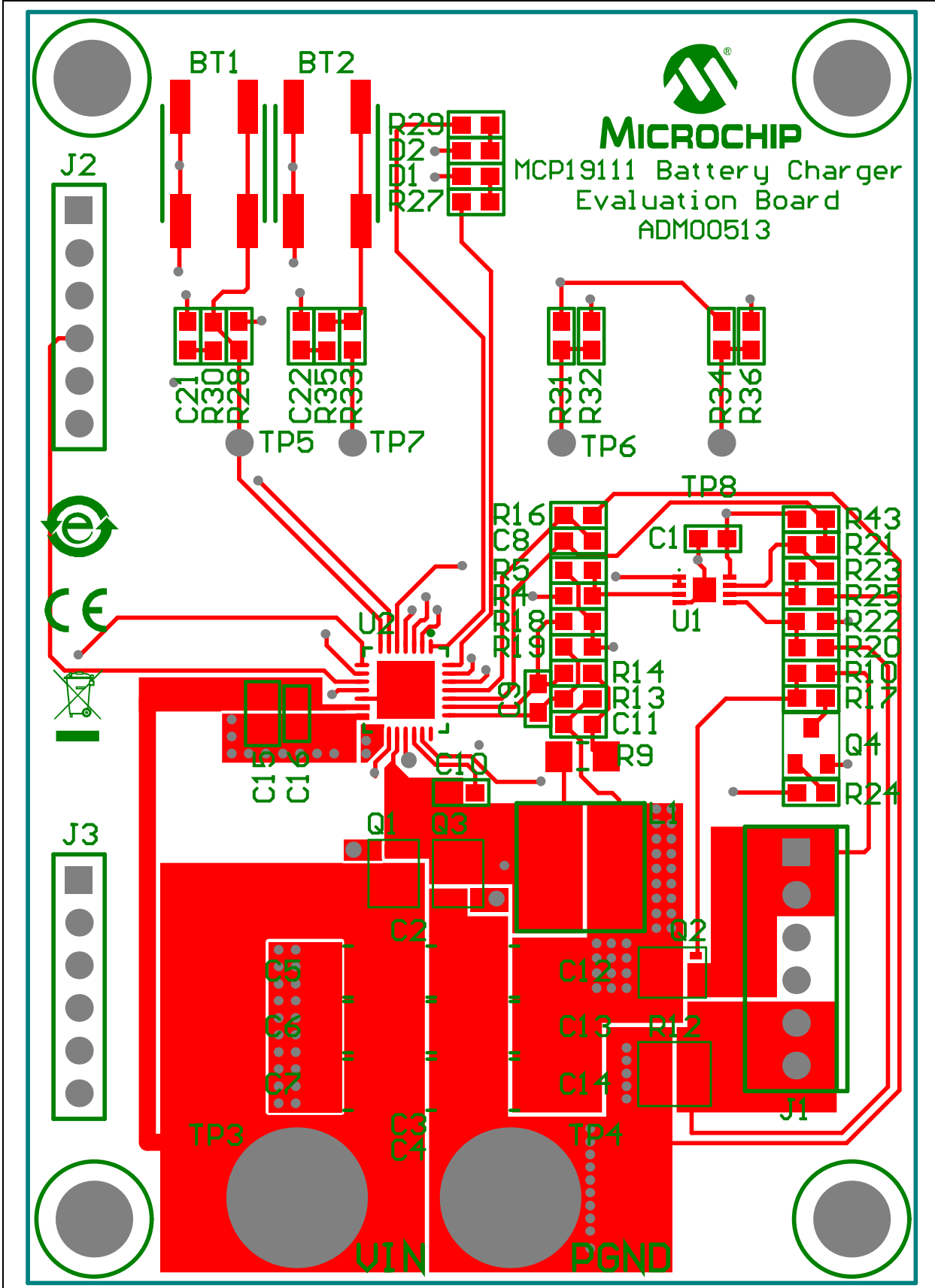

## A.6 BOARD – TOP COPPER

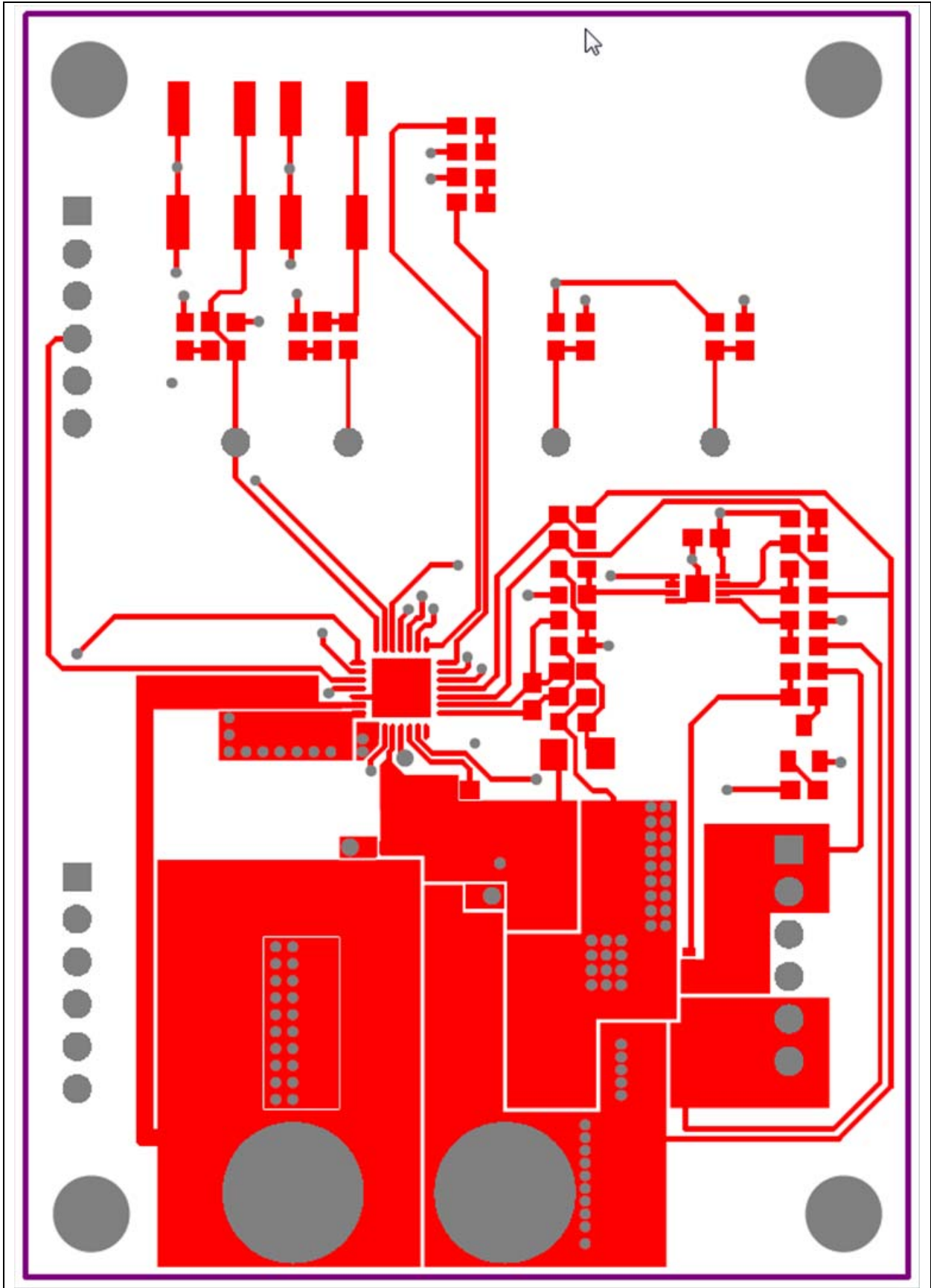

## A.7 BOARD – MID LAYER 1

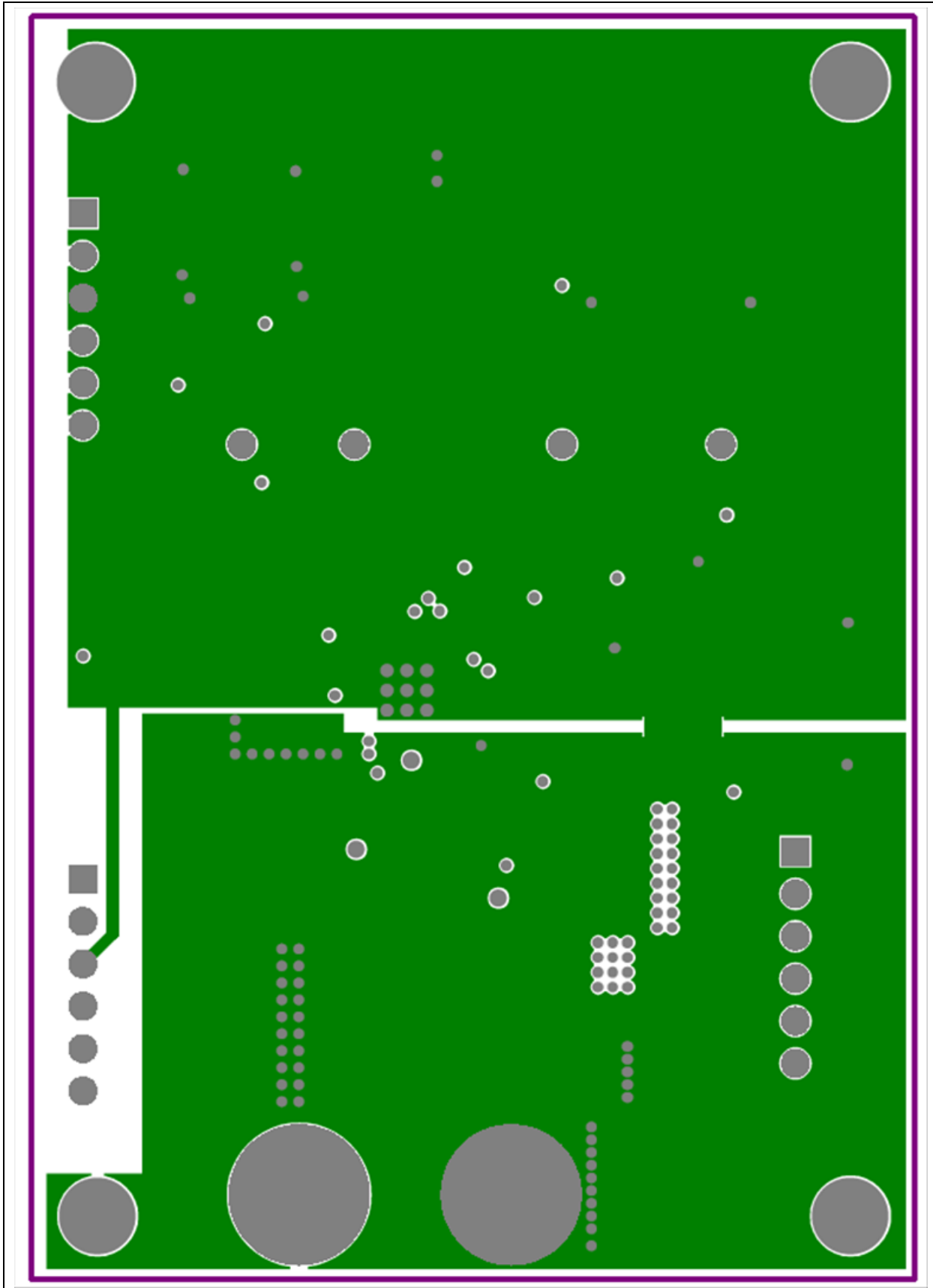

## A.8 BOARD – MID LAYER 2

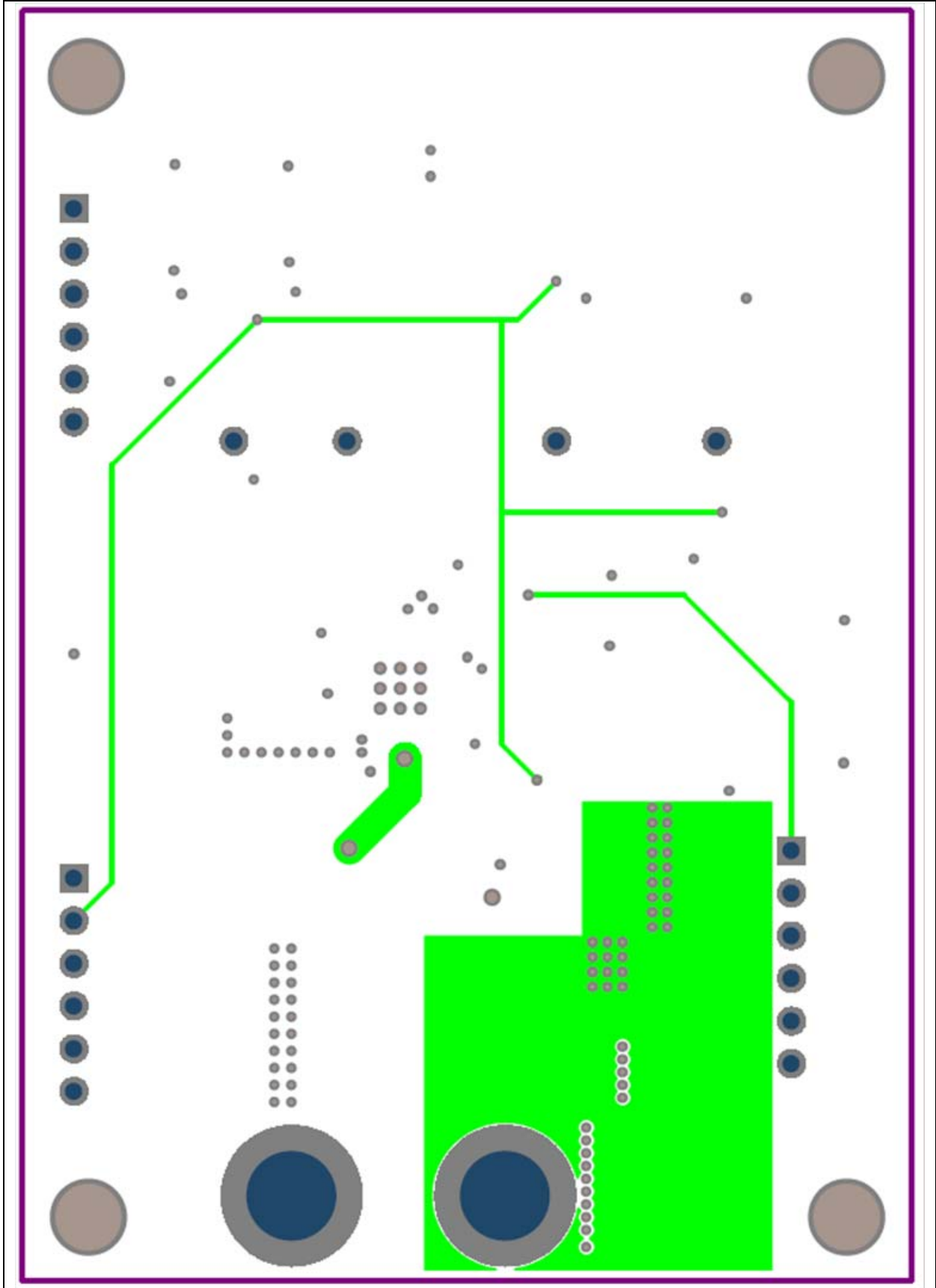

# MCP19111 Battery Charger Evaluation Board User's Guide

## A.9 BOARD – BOTTOM SILK

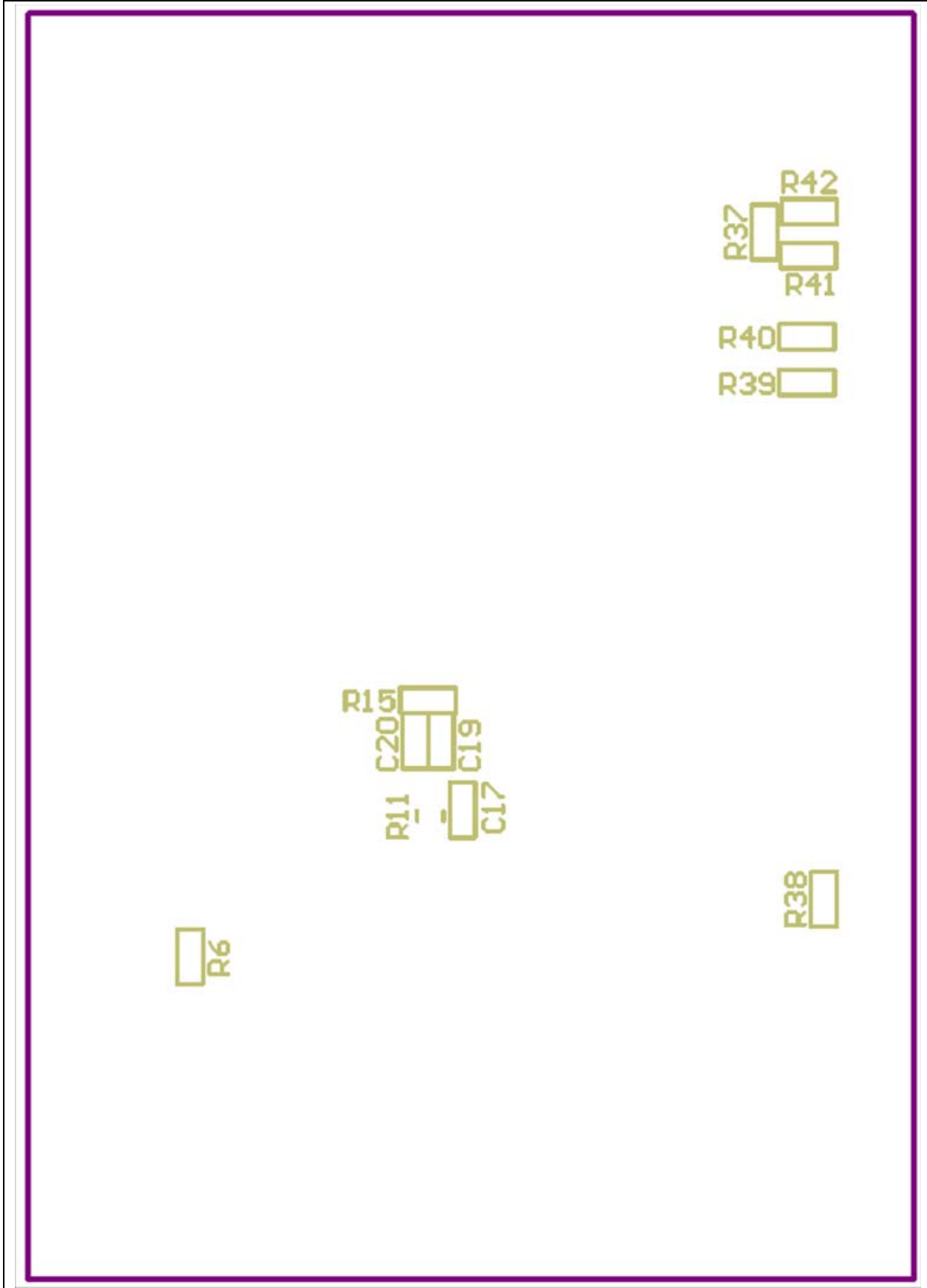

## A.10 BOARD – BOTTOM COPPER AND SILK

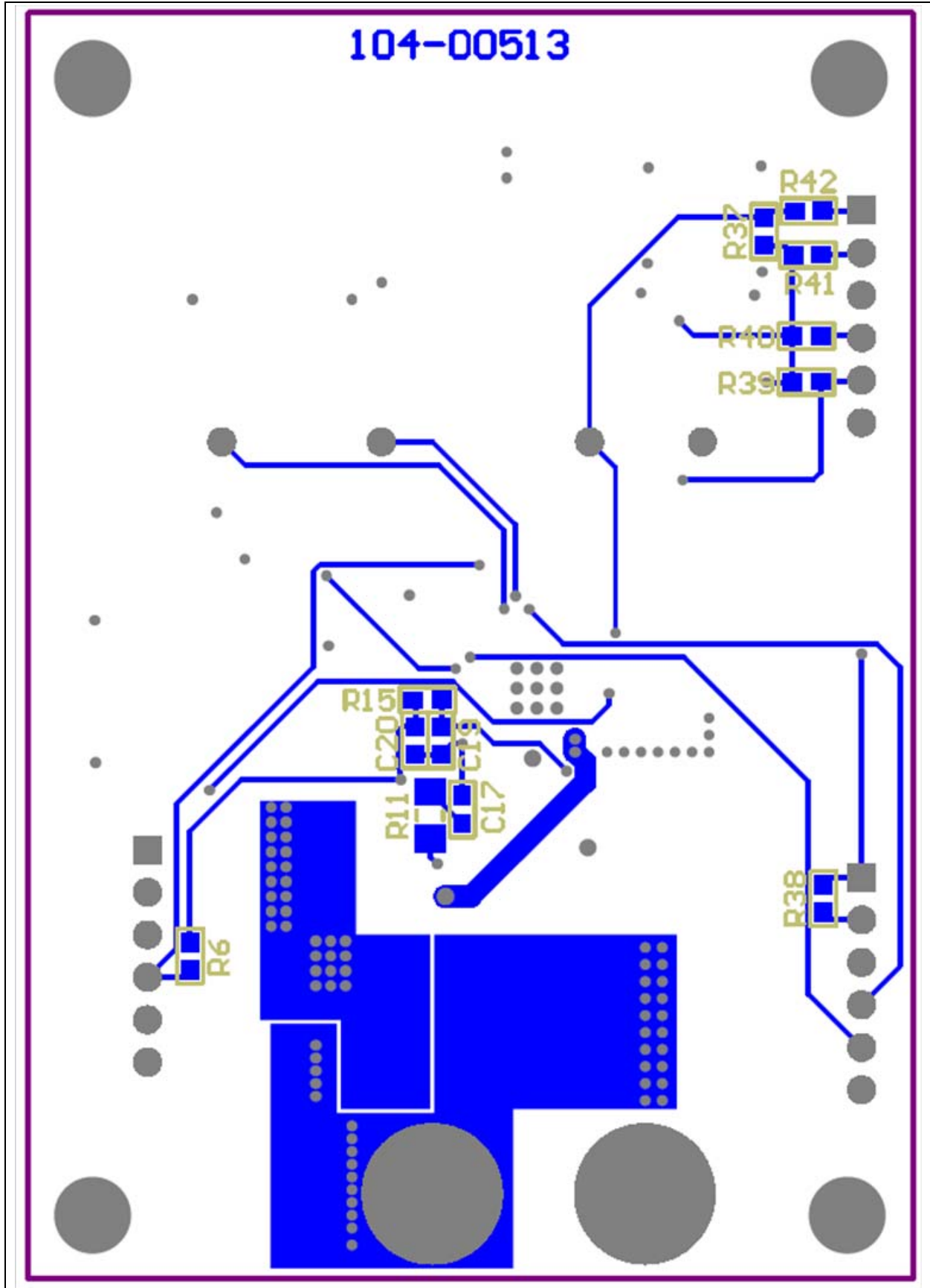

# MCP19111 Battery Charger Evaluation Board User's Guide

## A.11 BOARD – BOTTOM COPPER

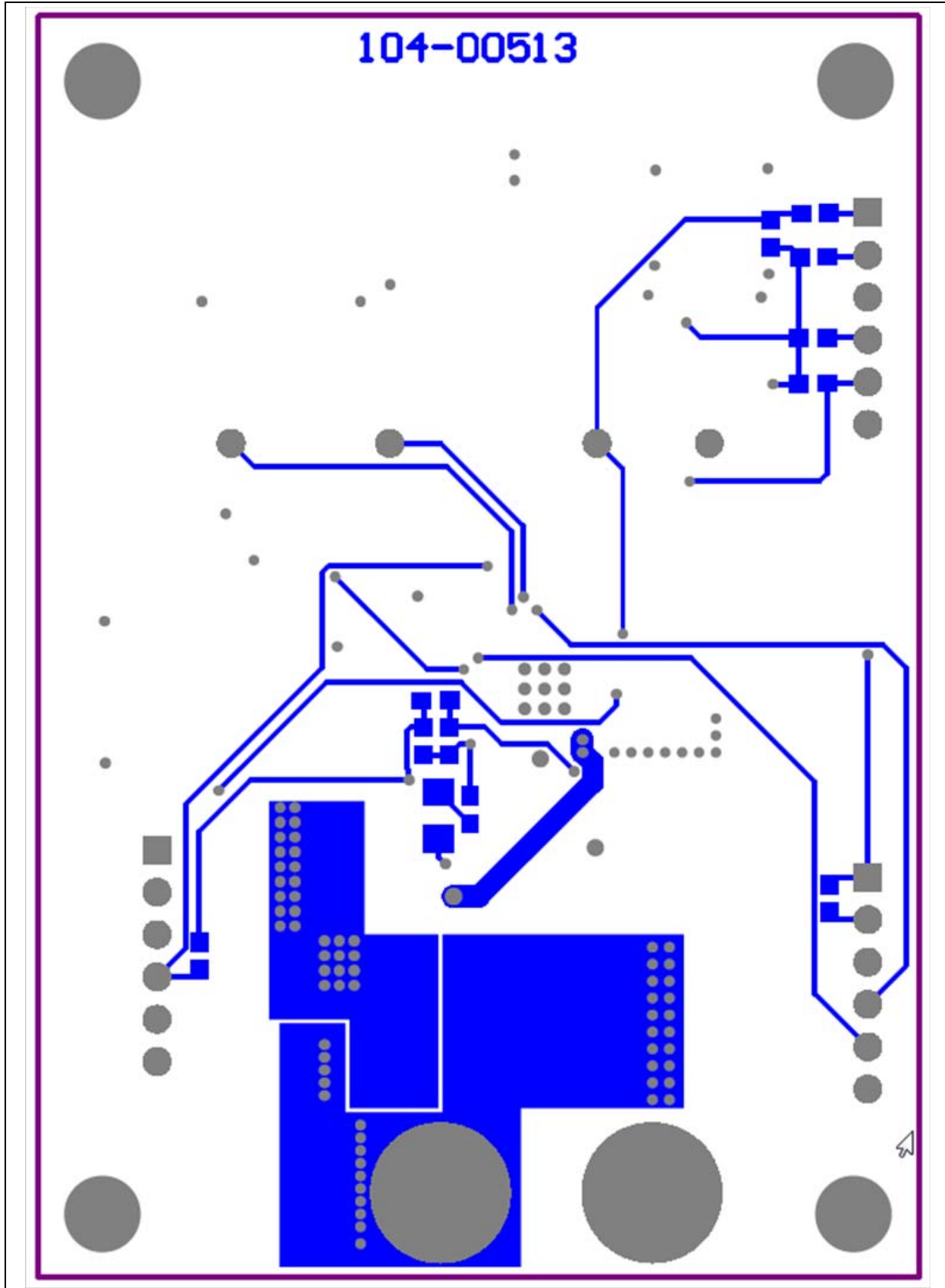





# MCP19111 BATTERY CHARGER EVALUATION BOARD USER'S GUIDE

## Appendix B. Bill of Materials

**TABLE B-1: BILL OF MATERIALS (BOM)<sup>(1)</sup>**

Qty	Reference	Description	Manufacturer	Part Number
2	BT1, BT2	Switch tact. SPST-NO 0.05A 12V	E-Switch <sup>®</sup> , Inc.	EG1868CT-ND
3	C1, C19, C20	Cap. Cer. 1 $\mu$ F 16V 10% X7R 0603	TDK Corporation	445-1604-1-ND
6	C2 – C7	Cap. Cer. 10 $\mu$ F 50V 10% X5R 1210	Taiyo Yuden Co., Ltd.	587-2247-1-ND
1	C8	Cap. Cer. 1000 pF 50V 10% X7R 0603	KEMET <sup>®</sup>	399-1082-1-ND
1	C9	Cap. Cer. 100 pF 50V 10% X7R 0603	KEMET	399-7824-1-ND
1	C10	Cap. Cer. 0.47 $\mu$ F 50V 20% X5R 0603	TDK Corporation	445-7418-6-ND
1	C11	Cap. Cer. 0.47 $\mu$ F 25V 10% X7R 0603	TDK Corporation	445-7465-1-ND
3	C12 – C14	Cap. Cer. 22 $\mu$ F 25V 20% X5R 1210	Taiyo Yuden Co., Ltd.	587-2086-1-ND
1	C15	Cap. Cer. 4.7 $\mu$ F 50V 10% X5R 0805	TDK Corporation	445-5980-1-ND
1	C16	Cap. Cer. 0.1 $\mu$ F 50V 10% X7R 0603	TDK Corporation	445-1314-1-ND
3	C17, C21, C22	<b>DO NOT POPULATE</b>		
1	D1	LED super red 0603 SMD	Vishay Intertechnology, Inc.	VLMS1300-GS08CT-ND
1	D2	<b>DO NOT POPULATE</b>		
1	J1	Conn. header Vert 6POS 0.100 TIN	TE Connectivity, Ltd.	A1923-ND
1	Housing – J1 <sup>(2)</sup>	Conn. Rcpt. HSN6 6POS	TE Connectivity	A99617-ND
2	J2 – J3	Conn. header R/A SGL 6POS GOLD	3M	3M9471-ND
1	L1	Inductor 5.6 $\mu$ H 13.67 m $\Omega$	Coilcraft	
2	Q1, Q3	MOSFET N-CH 60V 20A TSDSON-8	Infineon Technologies AG	BSZ110N06NS3GINCT-ND
1	Q2	MOSFET P-CH 20V 50A DFN3.3X3.3EP	Alpha and Omega Semiconductor, Inc.	785-1310-1-ND
1	Q4	MOSFET N-CH 40V 3A SOT23-3	Vishay Siliconix	SI2318DS-T1-E3
	PCB	Printed Circuit Board – MCP19111 Battery Charger Evaluation Board	—	104-00513
3	R24, R41 – R42	Res. 0.0 $\Omega$ 1/10W JUMP 0603 SMD	Panasonic <sup>®</sup> - ECG	P0.0GCT-ND
1	R12	Res. 0.010 $\Omega$ 1W 1% WIDE 1206	Susumu Co., LTD.	PRL1632.010FCT-ND
1	R4	Res. 1.80 M $\Omega$ 1/10W 1% 0603 SMD	Panasonic - ECG	P1.80MHCT-ND
1	R5	Res. 499 k $\Omega$ 1/10W 1% 0603 SMD	Panasonic - ECG	P499KHCT-ND
5	R6, R13 – R14, R28, R33	Res. 10.0 k $\Omega$ 1/10W 1% 0603 SMD	Panasonic - ECG	P10.0KHCT-ND
2	R22 – R23	Res. 20.0 k $\Omega$ 1/10W 1% 0603 SMD	Panasonic - ECG	P20.0KHCT-ND
1	R9	Res. 76 $\Omega$ 1/4W 1% 1206 SMD	Yageo	RMCF1206FT75R0CT-ND

**Note 1:** The components listed in this Bill of Materials are representative of the PCB assembly. The released BOM used in manufacturing uses all RoHS-compliant components.

**2:** Optional mating connector for battery pack.

# MCP19111 Battery Charger Evaluation Board User's Guide

**TABLE B-1: BILL OF MATERIALS (BOM)<sup>(1)</sup> (CONTINUED)**

Qty	Reference	Description	Manufacturer	Part Number
2	R10, R37	Res. 100 k $\Omega$ 1/10W 1% 0603 SMD	Panasonic - ECG	P100KHCT-ND
1	R15	Res. 10.0 $\Omega$ 1/10W 1% 0603 SMD	Panasonic - ECG	P10.0HCT-ND
2	R16, R21	Res. 1.00 k $\Omega$ 1/10W 1% 0603 SMD	Panasonic - ECG	P1.00KHCT-ND
1	R17	Res. 49.9 k $\Omega$ 1/10W 1% 0603 SMD	Panasonic - ECG	P49.9KHCT-ND
2	R18 – R19	Res. 3.30 k $\Omega$ 1/10W 1% 0603 SMD3	Panasonic - ECG	P3.30KHCT-ND
3	R20, R25, R27	Res. 510 $\Omega$ 1/10W 1% 0603 SMD	Panasonic - ECG	P510HCT-ND
3	R38 – R40	Res. 4.99 k $\Omega$ 1/10W 1% 0603 SMD	Panasonic - ECG	P4.99KHCT-ND
1	R43	Res. 15.8 k $\Omega$ 1/10W 1% 0603 SMD	Panasonic - ECG	P15.8KHCT-ND
8	R11, R29 – R32, R34 – R36	<b>DO NOT POPULATE</b>		
2	TP3 – TP4	Jack Non-Insulated 350	Keystone Electronics Corp.	575-8K-ND
4	TP5 – TP8	<b>DO NOT POPULATE</b>		
1	U1	High Precision Op. Amp.	Microchip Technology Inc.	<b>MCP6072-E/MNY</b>
1	U2	MCP19111 Enhanced Power Analog Controller with Integrated Driver	Microchip Technology Inc.	<b>MCP19111-E/MQ</b>
4	6-32 Screw	Machine Screw Pan Phillips 6-32	APM HEXSEAL <sup>®</sup>	335-1093-ND
4	6-32 Standoff	Standoff Hex 6-32THR ALUM 500"L	Keystone Electronics Corp.	2210K-ND

**Note 1:** The components listed in this Bill of Materials are representative of the PCB assembly. The released BOM used in manufacturing uses all RoHS-compliant components.

**2:** Optional mating connector for battery pack.

**Appendix C. Charge Profile Block Diagrams**

**C.1 INTRODUCTION**

Figures C-1 to C-13 show block diagrams for the various charge profiles. The block diagrams show the flow of logic that enables the MCP19111 to control the charge cycle for efficient battery charging.

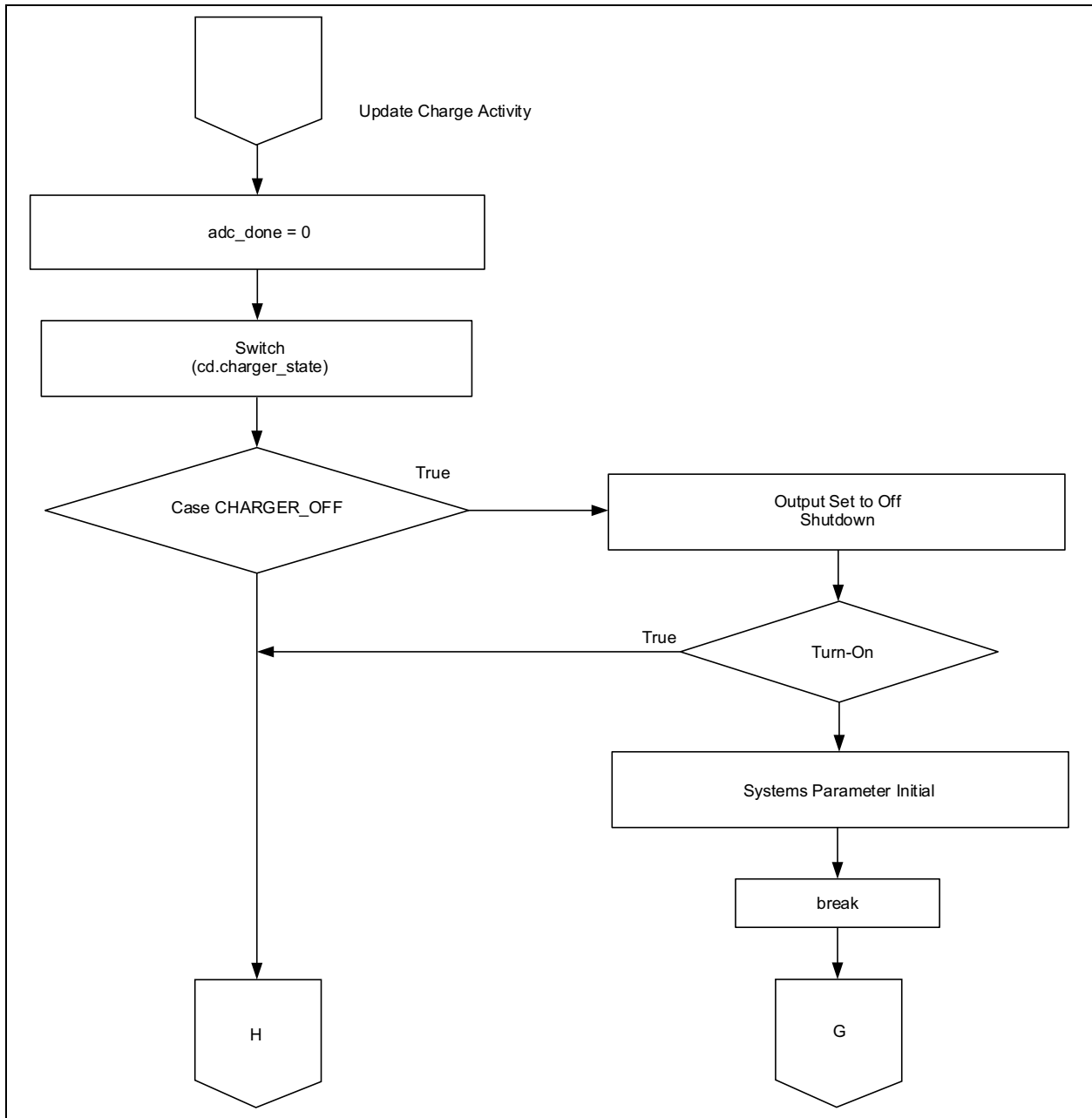

**FIGURE C-1:** Block Diagram of Battery Charger Off-to-On Logic.

# MCP19111 Battery Charger Evaluation Board User's Guide

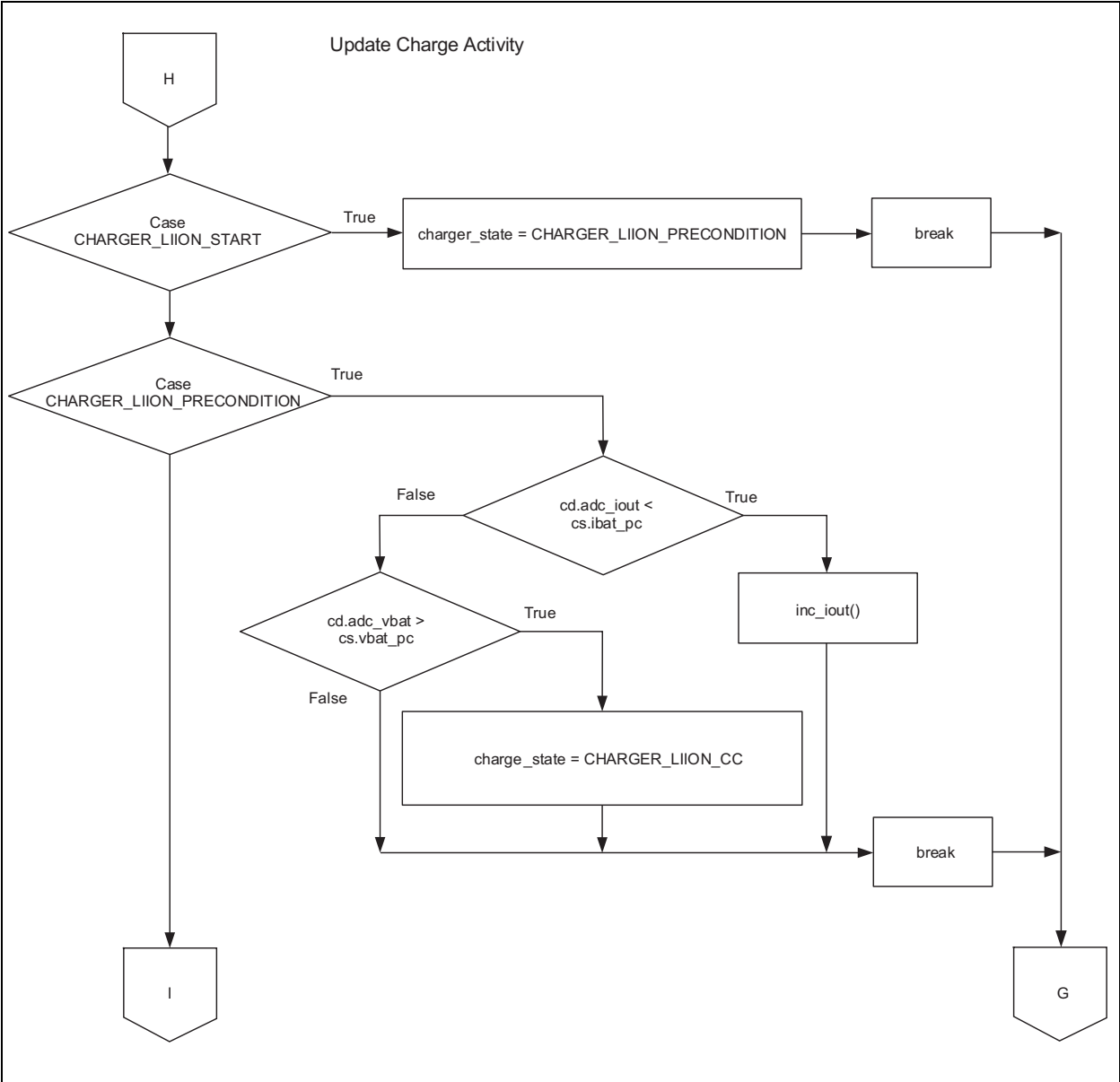

**FIGURE C-2:** Block Diagram of Li-Ion Profile Initialization.

# Charge Profile Block Diagrams

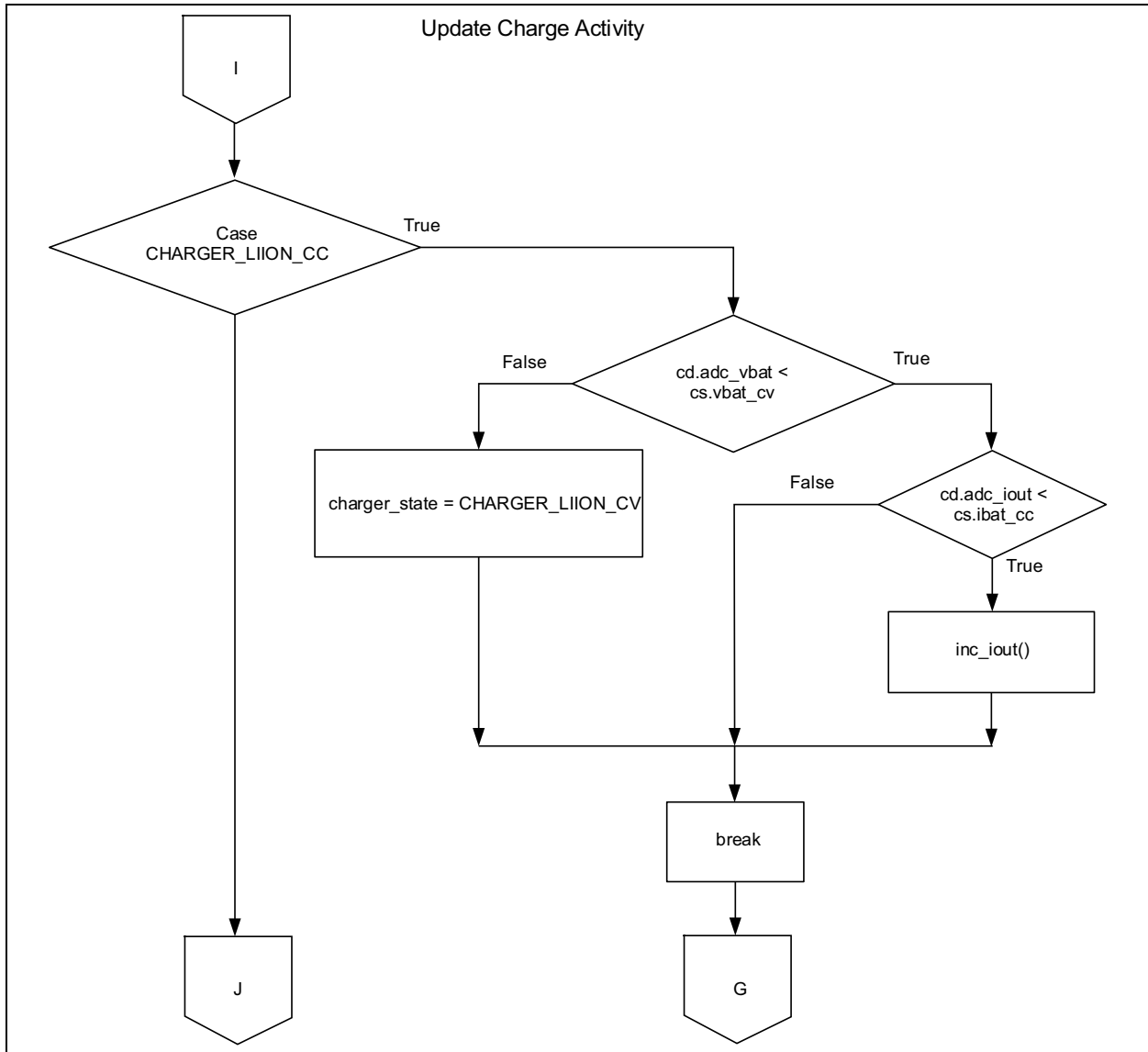

**FIGURE C-3:** Block Diagram of Transition to Li-Ion Constant Current Charging Mode.

# MCP19111 Battery Charger Evaluation Board User's Guide

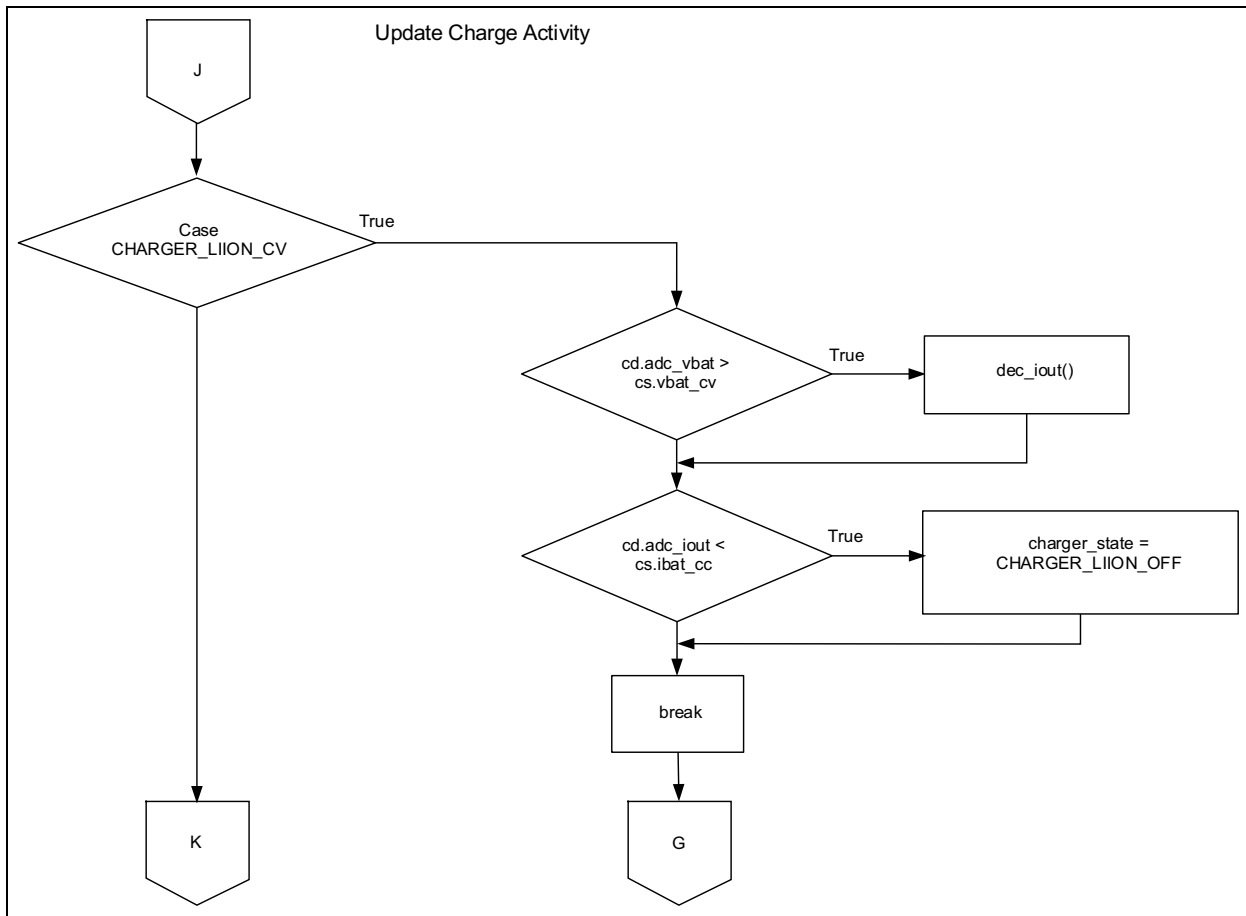

**FIGURE C-4:** Block Diagram of Li-Ion Profile Termination.

# Charge Profile Block Diagrams

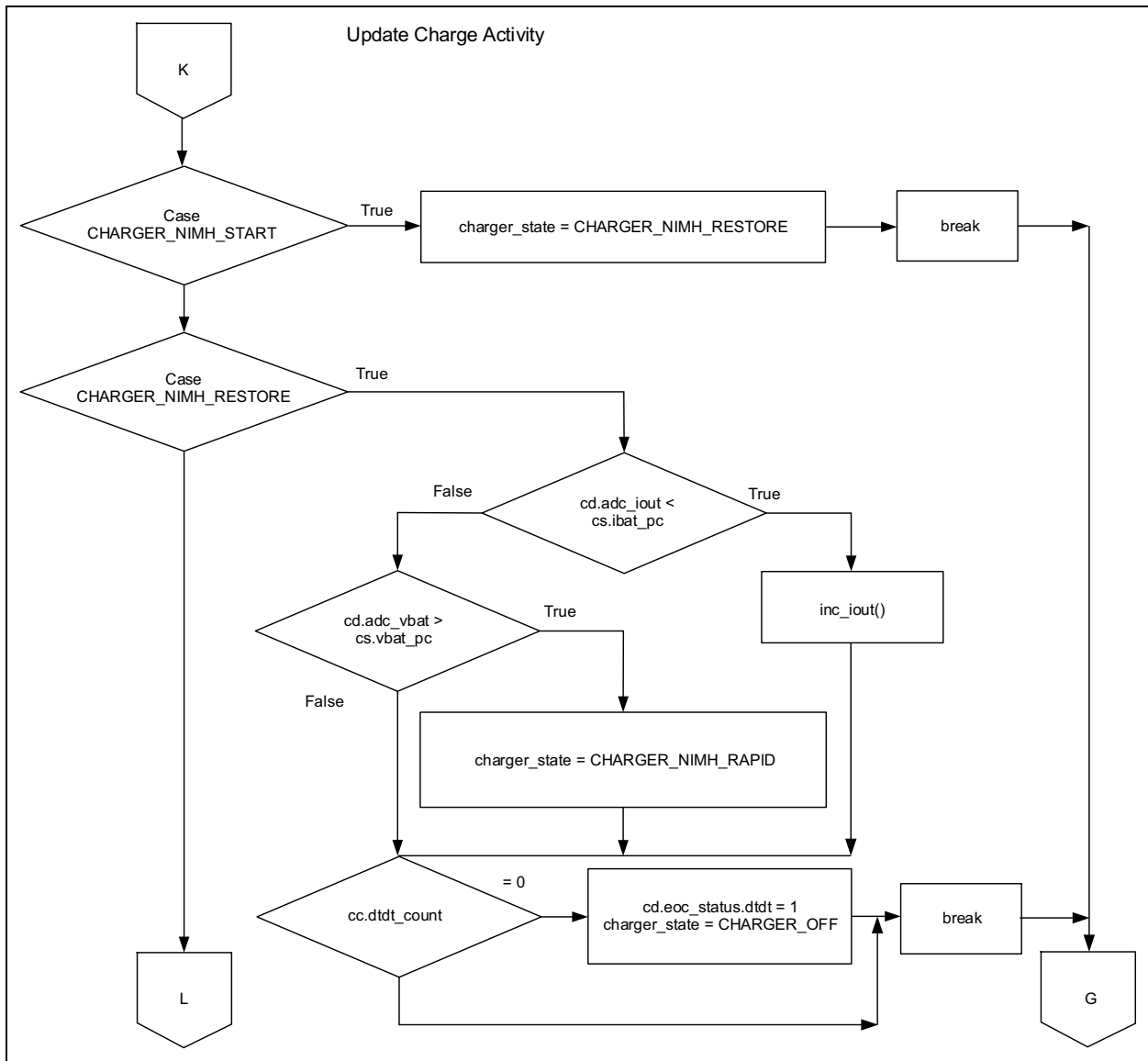

**FIGURE C-5:** Block Diagram of NiMH Profile Initialization and Transition to Rapid Charge Mode.

# MCP19111 Battery Charger Evaluation Board User's Guide

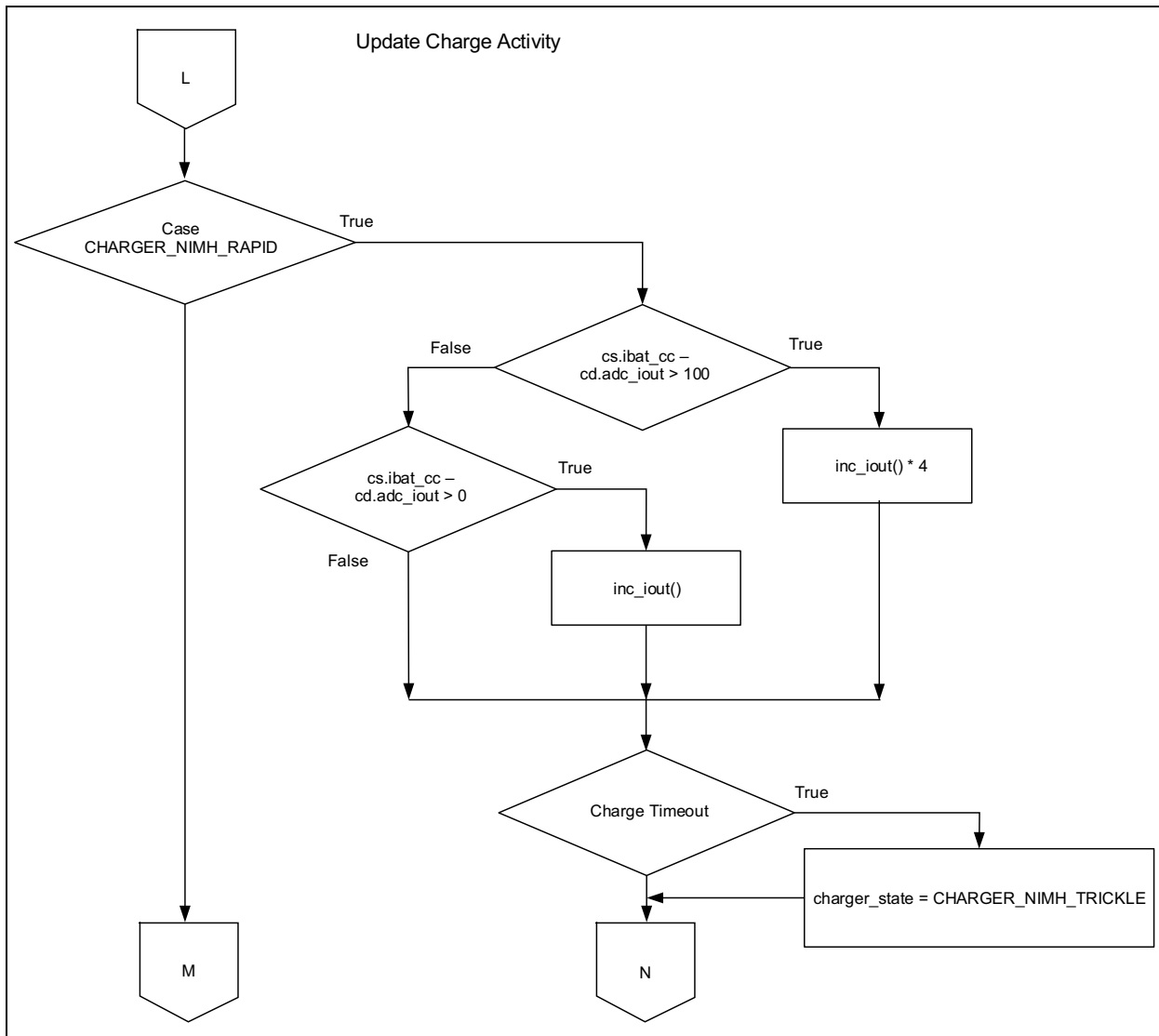

**FIGURE C-6:** Block Diagram of NiMH Profile Transition to Trickle Charge Mode.



# Charge Profile Block Diagrams

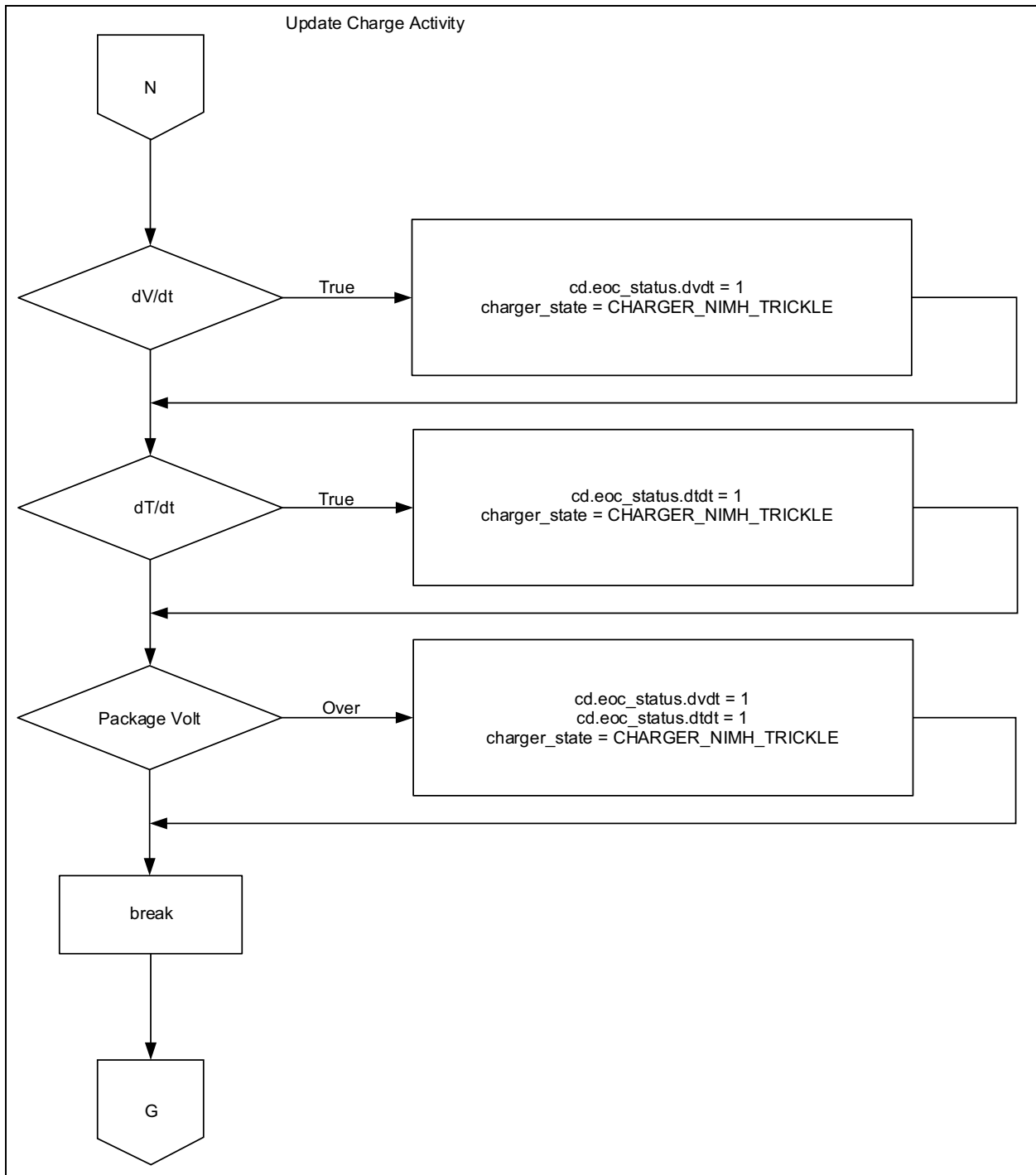

**FIGURE C-7:** Block Diagram of Voltage and Temperature Sense Termination Logic for NiMH Profile.

# MCP19111 Battery Charger Evaluation Board User's Guide

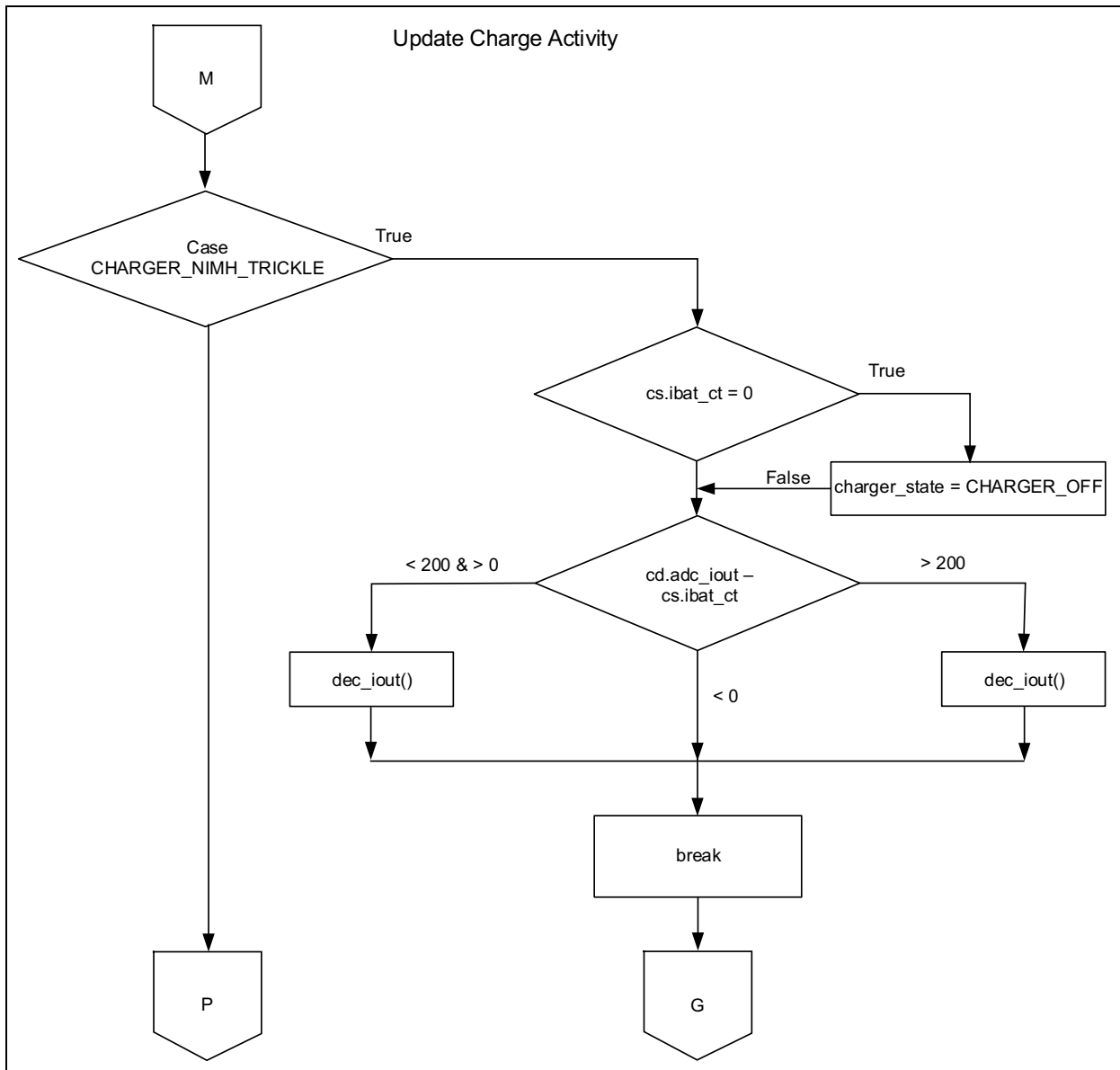

**FIGURE C-8:** Block Diagram of NiMH Profile Charge Termination.

# Charge Profile Block Diagrams

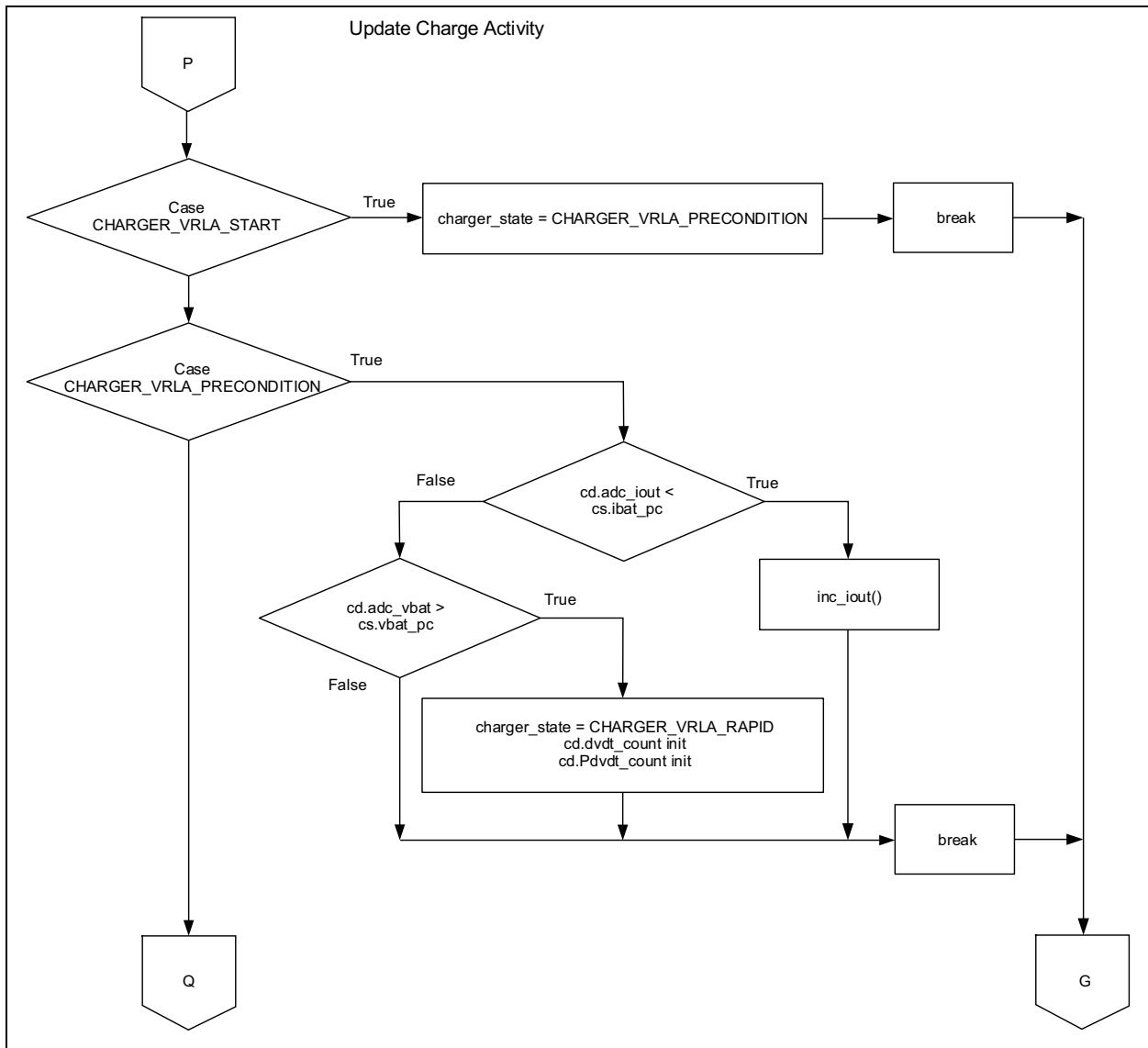

**FIGURE C-9:** Block Diagram of VRLA Profile Initialization and Transition to Rapid Charge Mode.

# MCP19111 Battery Charger Evaluation Board User's Guide

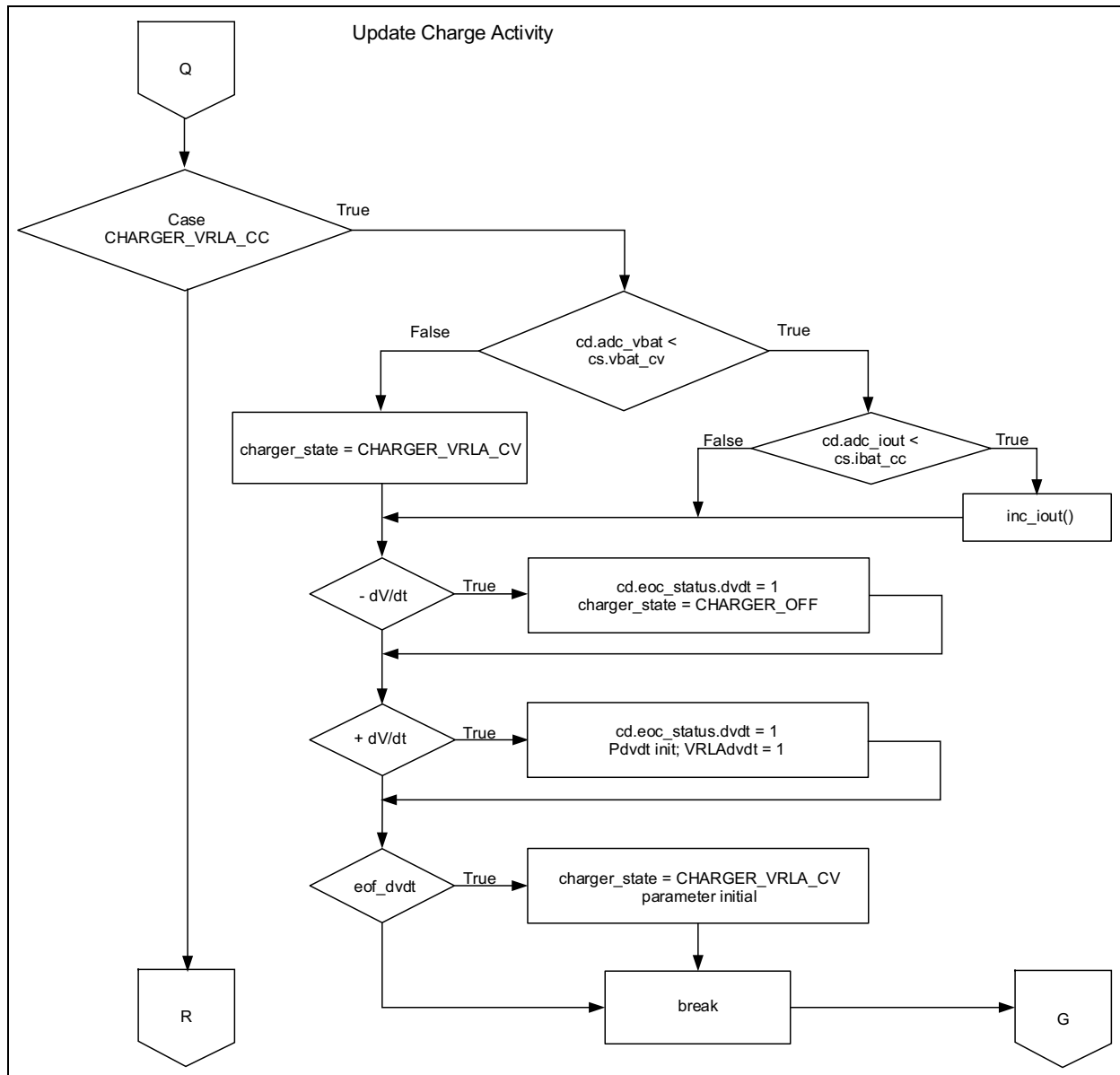

**FIGURE C-10:** Block Diagram of Transition to Constant Voltage Mode.

# Charge Profile Block Diagrams

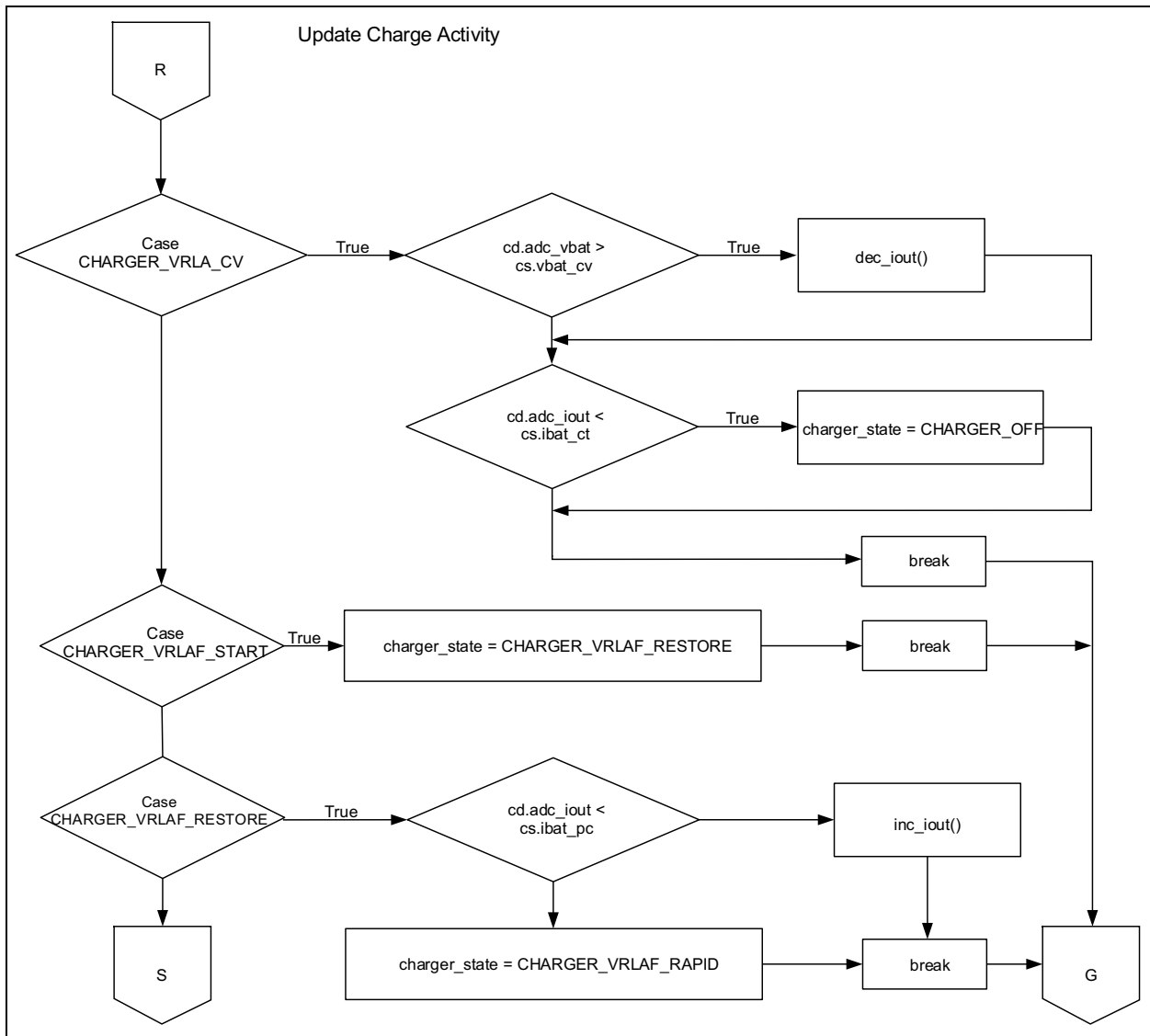

**FIGURE C-11:** Block Diagram of VRLA CCCP Charge Termination and VRLA Fast Profile Initialization.

# MCP19111 Battery Charger Evaluation Board User's Guide

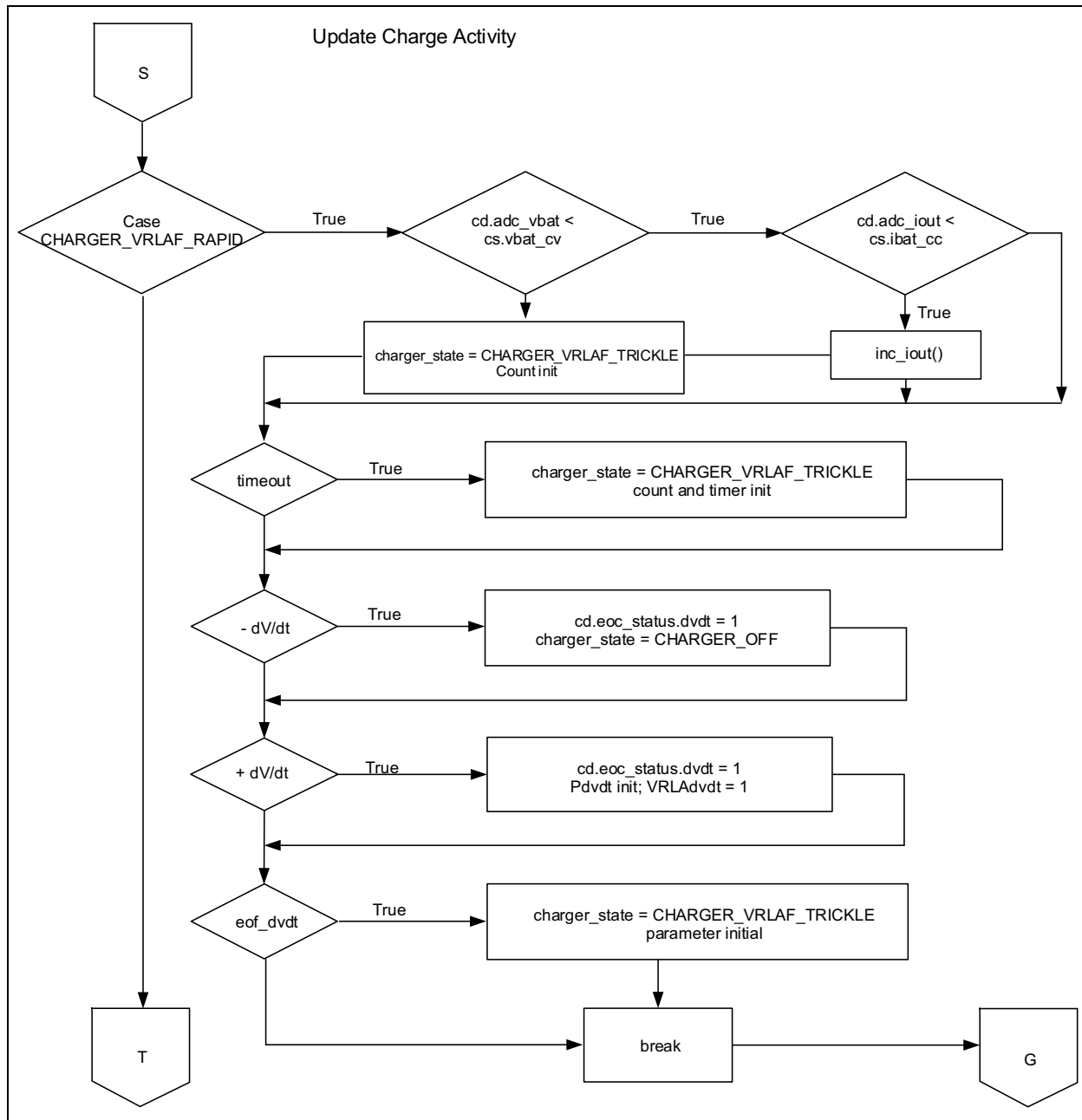

**FIGURE C-12:** Block Diagram of VRLA Fast Charge Profile Logic.

# Charge Profile Block Diagrams

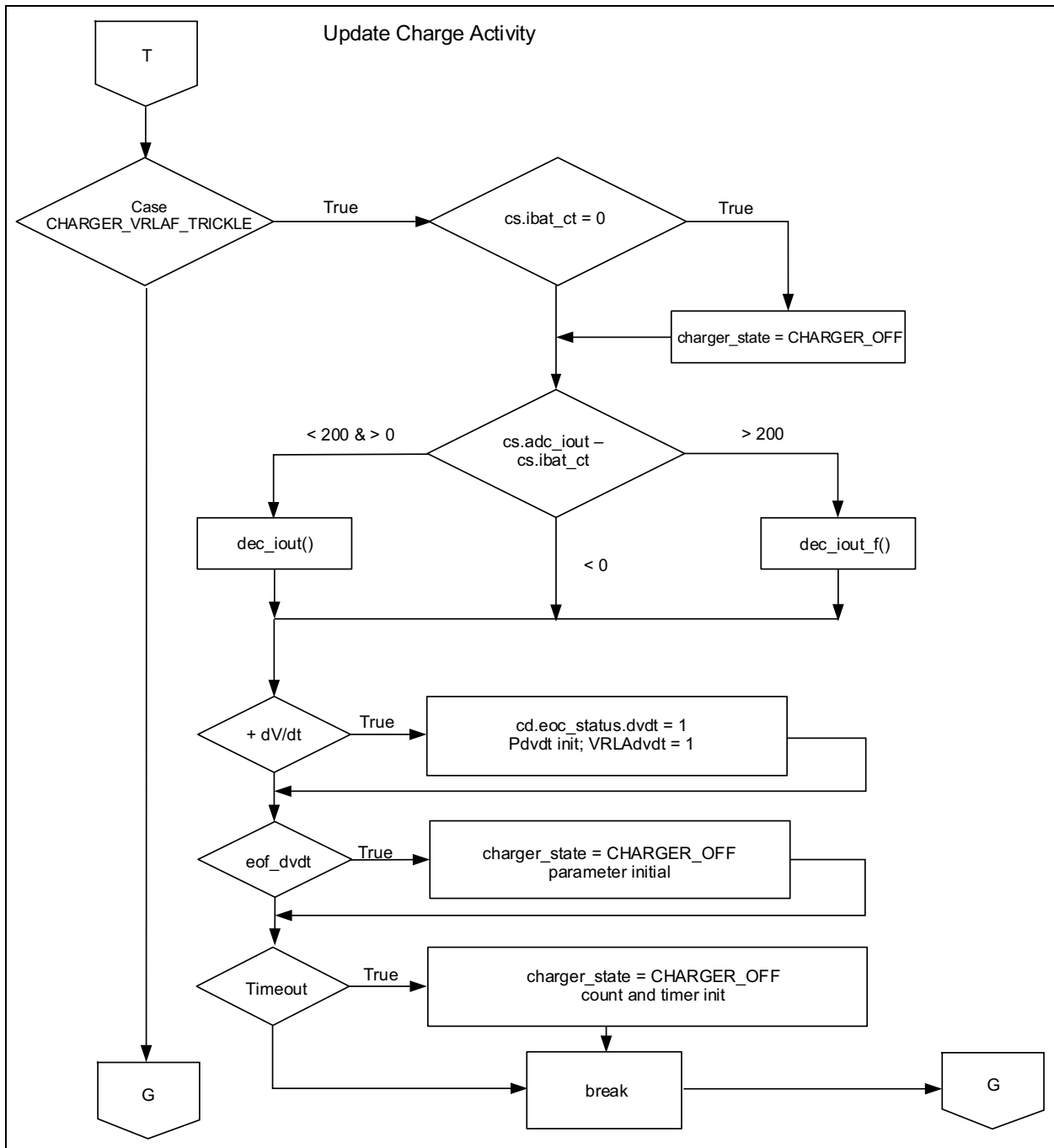

**FIGURE C-13:** Block Diagram of VRLA Fast Trickle Charge Mode and Profile Termination.



# MICROCHIP

## Worldwide Sales and Service

### AMERICAS

**Corporate Office**  
2355 West Chandler Blvd.  
Chandler, AZ 85224-6199  
Tel: 480-792-7200  
Fax: 480-792-7277  
Technical Support:  
<http://www.microchip.com/support>  
Web Address:  
[www.microchip.com](http://www.microchip.com)

**Atlanta**  
Duluth, GA  
Tel: 678-957-9614  
Fax: 678-957-1455

**Austin, TX**  
Tel: 512-257-3370

**Boston**  
Westborough, MA  
Tel: 774-760-0087  
Fax: 774-760-0088

**Chicago**  
Itasca, IL  
Tel: 630-285-0071  
Fax: 630-285-0075

**Cleveland**  
Independence, OH  
Tel: 216-447-0464  
Fax: 216-447-0643

**Dallas**  
Addison, TX  
Tel: 972-818-7423  
Fax: 972-818-2924

**Detroit**  
Novi, MI  
Tel: 248-848-4000

**Houston, TX**  
Tel: 281-894-5983

**Indianapolis**  
Noblesville, IN  
Tel: 317-773-8323  
Fax: 317-773-5453

**Los Angeles**  
Mission Viejo, CA  
Tel: 949-462-9523  
Fax: 949-462-9608

**New York, NY**  
Tel: 631-435-6000

**San Jose, CA**  
Tel: 408-735-9110

**Canada - Toronto**  
Tel: 905-673-0699  
Fax: 905-673-6509

### ASIA/PACIFIC

**Asia Pacific Office**  
Suites 3707-14, 37th Floor  
Tower 6, The Gateway  
Harbour City, Kowloon  
Hong Kong  
Tel: 852-2943-5100  
Fax: 852-2401-3431

**Australia - Sydney**  
Tel: 61-2-9868-6733  
Fax: 61-2-9868-6755

**China - Beijing**  
Tel: 86-10-8569-7000  
Fax: 86-10-8528-2104

**China - Chengdu**  
Tel: 86-28-8665-5511  
Fax: 86-28-8665-7889

**China - Chongqing**  
Tel: 86-23-8980-9588  
Fax: 86-23-8980-9500

**China - Hangzhou**  
Tel: 86-571-8792-8115  
Fax: 86-571-8792-8116

**China - Hong Kong SAR**  
Tel: 852-2943-5100  
Fax: 852-2401-3431

**China - Nanjing**  
Tel: 86-25-8473-2460  
Fax: 86-25-8473-2470

**China - Qingdao**  
Tel: 86-532-8502-7355  
Fax: 86-532-8502-7205

**China - Shanghai**  
Tel: 86-21-5407-5533  
Fax: 86-21-5407-5066

**China - Shenyang**  
Tel: 86-24-2334-2829  
Fax: 86-24-2334-2393

**China - Shenzhen**  
Tel: 86-755-8864-2200  
Fax: 86-755-8203-1760

**China - Wuhan**  
Tel: 86-27-5980-5300  
Fax: 86-27-5980-5118

**China - Xian**  
Tel: 86-29-8833-7252  
Fax: 86-29-8833-7256

**China - Xiamen**  
Tel: 86-592-2388138  
Fax: 86-592-2388130

**China - Zhuhai**  
Tel: 86-756-3210040  
Fax: 86-756-3210049

### ASIA/PACIFIC

**India - Bangalore**  
Tel: 91-80-3090-4444  
Fax: 91-80-3090-4123

**India - New Delhi**  
Tel: 91-11-4160-8631  
Fax: 91-11-4160-8632

**India - Pune**  
Tel: 91-20-3019-1500

**Japan - Osaka**  
Tel: 81-6-6152-7160  
Fax: 81-6-6152-9310

**Japan - Tokyo**  
Tel: 81-3-6880-3770  
Fax: 81-3-6880-3771

**Korea - Daegu**  
Tel: 82-53-744-4301  
Fax: 82-53-744-4302

**Korea - Seoul**  
Tel: 82-2-554-7200  
Fax: 82-2-558-5932 or  
82-2-558-5934

**Malaysia - Kuala Lumpur**  
Tel: 60-3-6201-9857  
Fax: 60-3-6201-9859

**Malaysia - Penang**  
Tel: 60-4-227-8870  
Fax: 60-4-227-4068

**Philippines - Manila**  
Tel: 63-2-634-9065  
Fax: 63-2-634-9069

**Singapore**  
Tel: 65-6334-8870  
Fax: 65-6334-8850

**Taiwan - Hsin Chu**  
Tel: 886-3-5778-366  
Fax: 886-3-5770-955

**Taiwan - Kaohsiung**  
Tel: 886-7-213-7830

**Taiwan - Taipei**  
Tel: 886-2-2508-8600  
Fax: 886-2-2508-0102

**Thailand - Bangkok**  
Tel: 66-2-694-1351  
Fax: 66-2-694-1350

### EUROPE

**Austria - Wels**  
Tel: 43-7242-2244-39  
Fax: 43-7242-2244-393

**Denmark - Copenhagen**  
Tel: 45-4450-2828  
Fax: 45-4485-2829

**France - Paris**  
Tel: 33-1-69-53-63-20  
Fax: 33-1-69-30-90-79

**Germany - Dusseldorf**  
Tel: 49-2129-3766400

**Germany - Munich**  
Tel: 49-89-627-144-0  
Fax: 49-89-627-144-44

**Germany - Pforzheim**  
Tel: 49-7231-424750

**Italy - Milan**  
Tel: 39-0331-742611  
Fax: 39-0331-466781

**Italy - Venice**  
Tel: 39-049-7625286

**Netherlands - Drunen**  
Tel: 31-416-690399  
Fax: 31-416-690340

**Poland - Warsaw**  
Tel: 48-22-3325737

**Spain - Madrid**  
Tel: 34-91-708-08-90  
Fax: 34-91-708-08-91

**Sweden - Stockholm**  
Tel: 46-8-5090-4654

**UK - Wokingham**  
Tel: 44-118-921-5800  
Fax: 44-118-921-5820

03/25/14