

LOC		DJUST		REVISIONS			
P	LTR	DESCRIPTION	DATE	DWN	APVD		
CM	53	E	REV & REDWN PER EC	0L30-0073-96	10-11-96	JH	RS

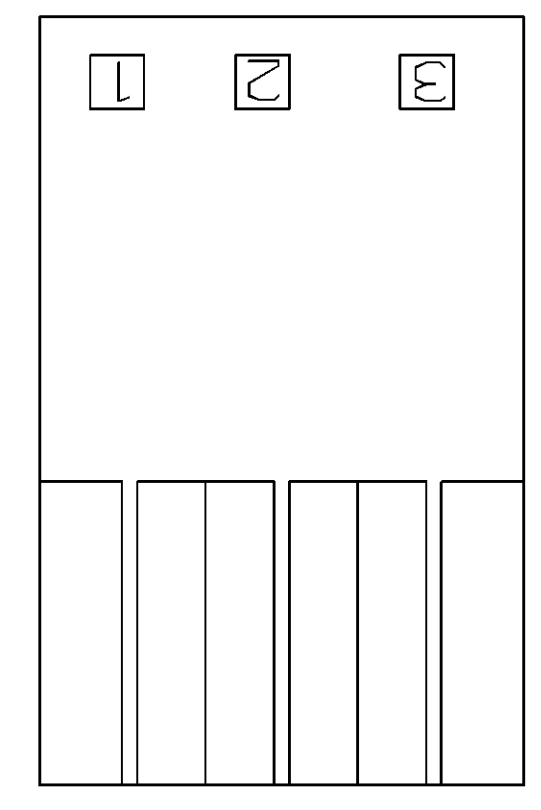

△1 MATERIAL: NYLON UL94V-2 (NATURAL).  
 △2 MARKING FOR UL LOGO AND CSA LOGO LOCATED APPROXIMATELY AS SHOWN.

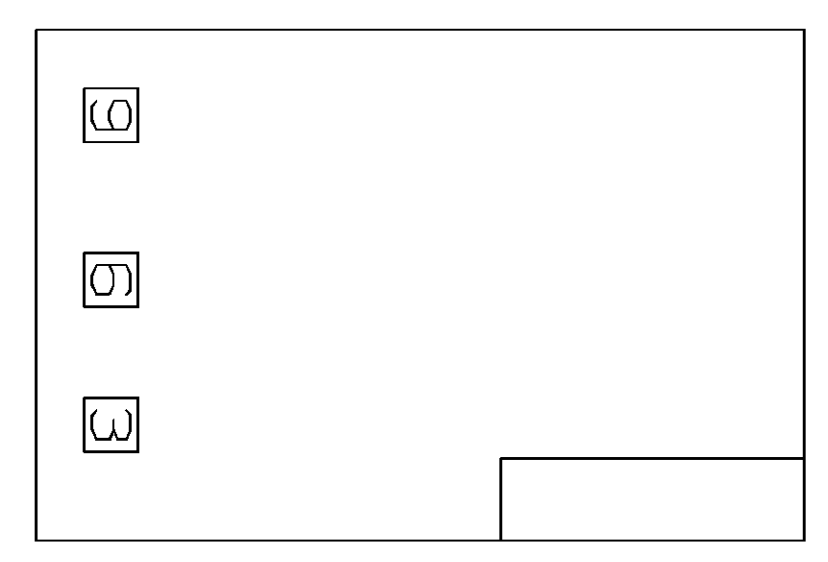
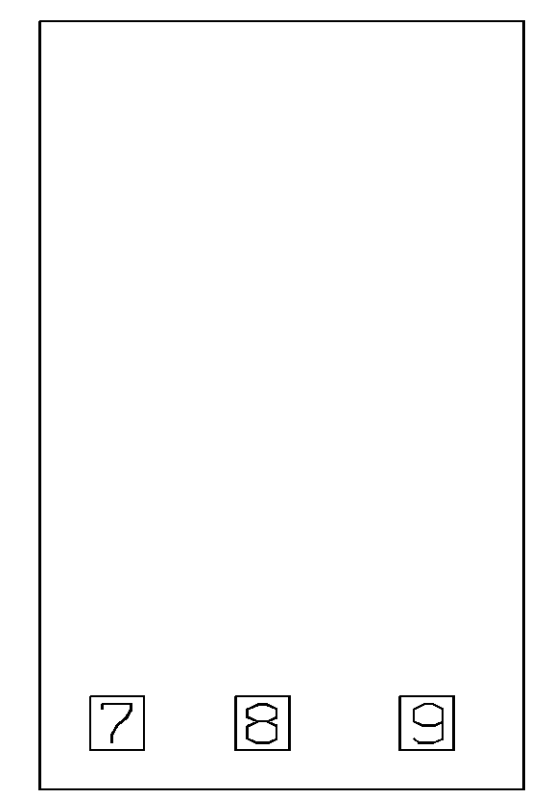
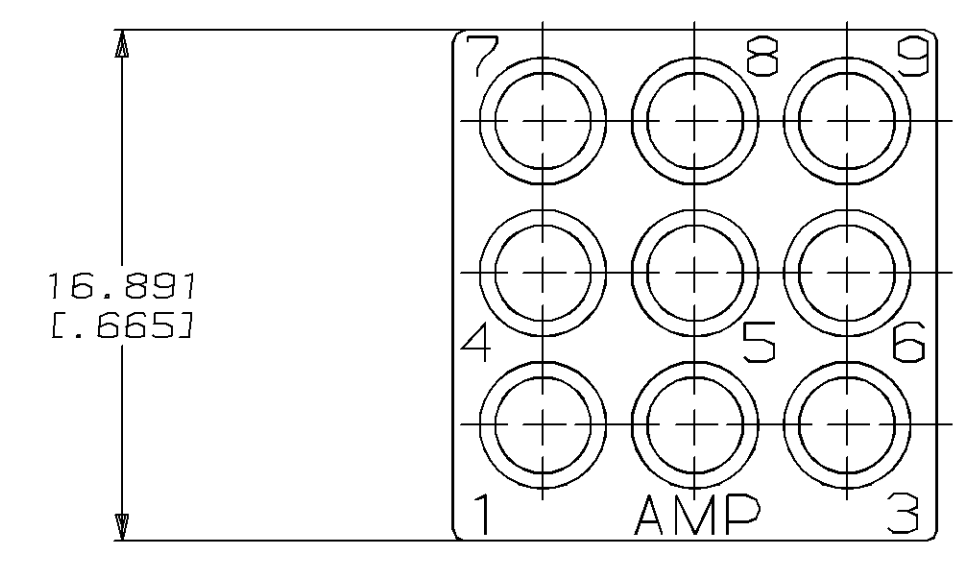
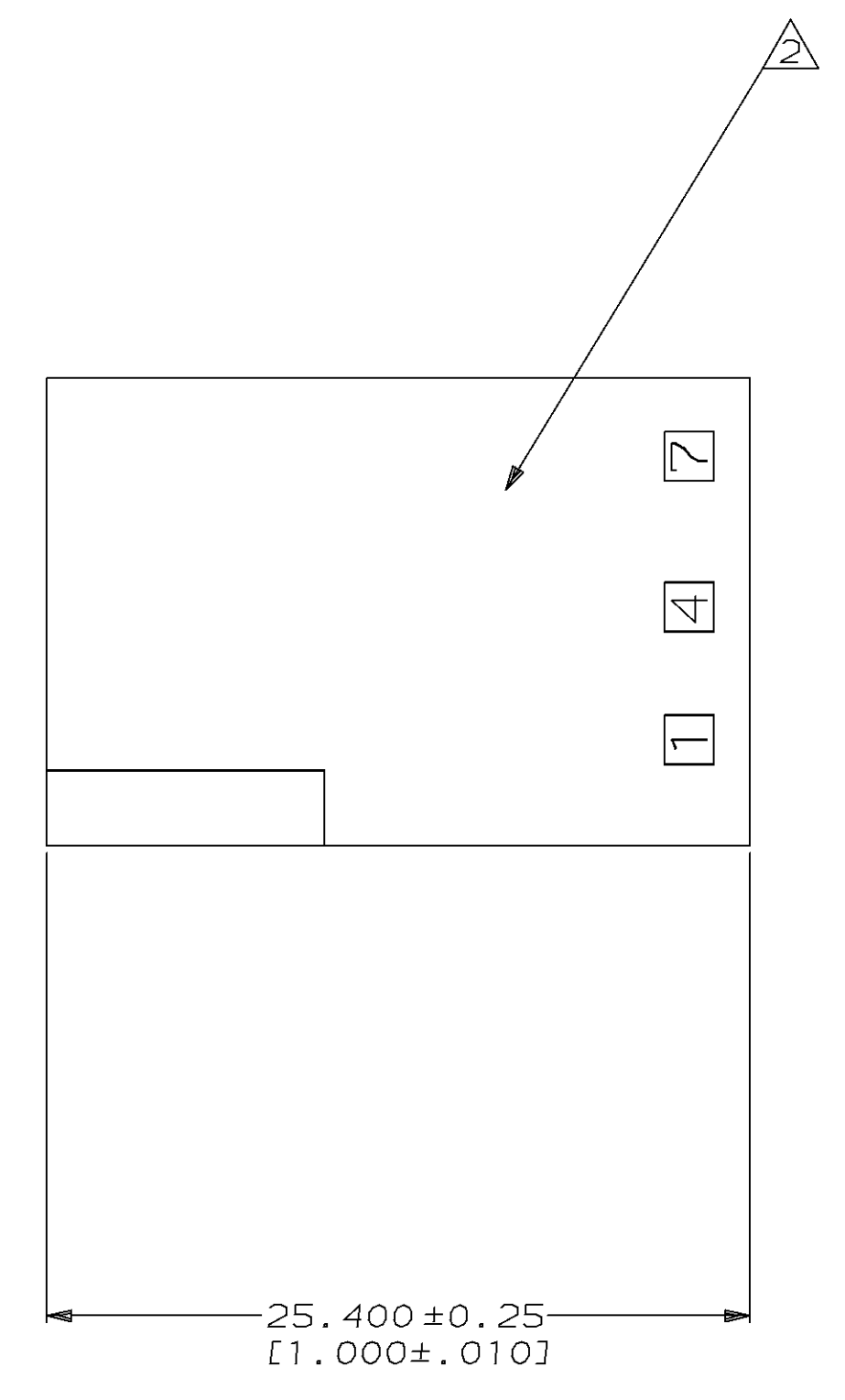
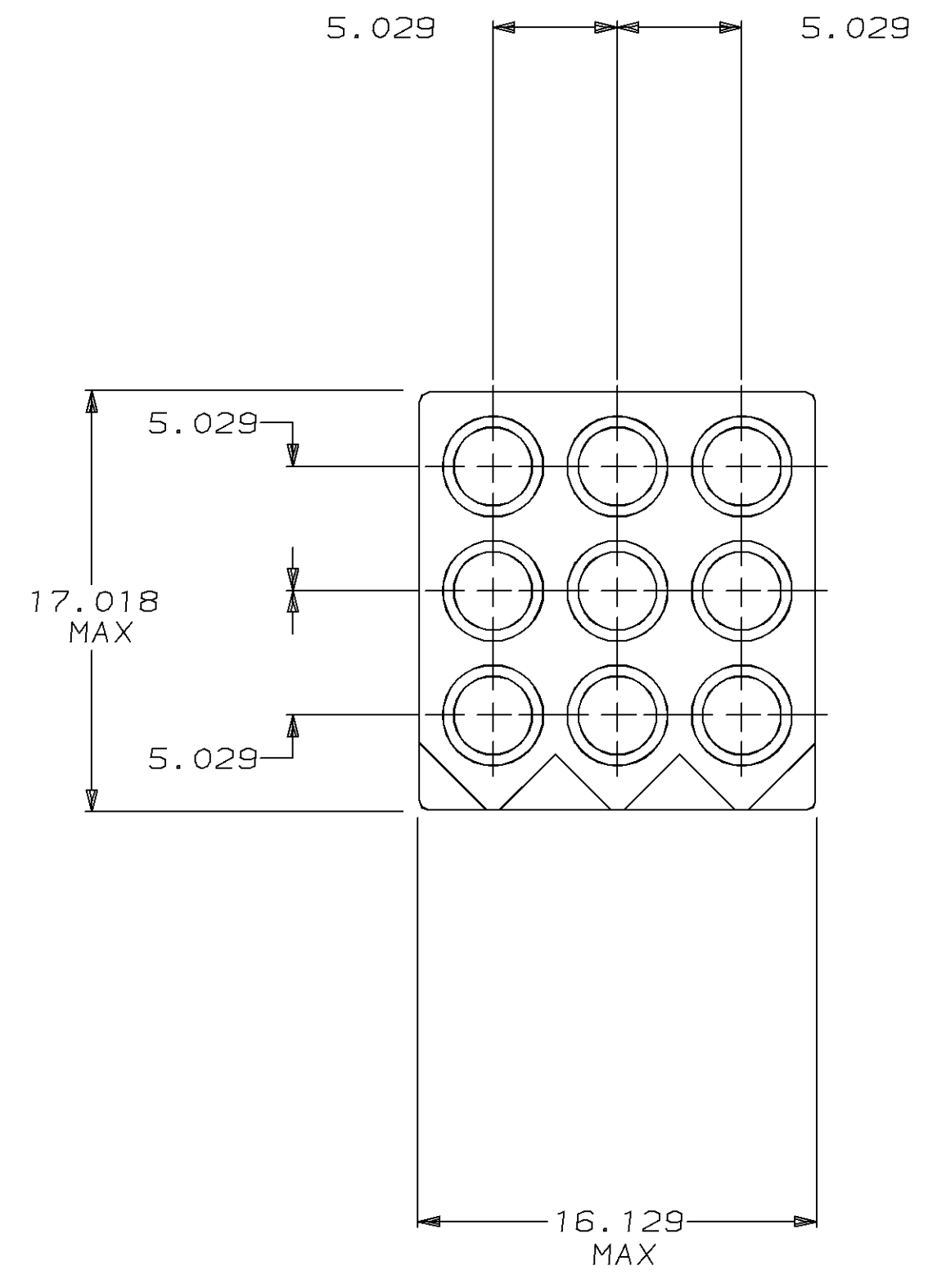
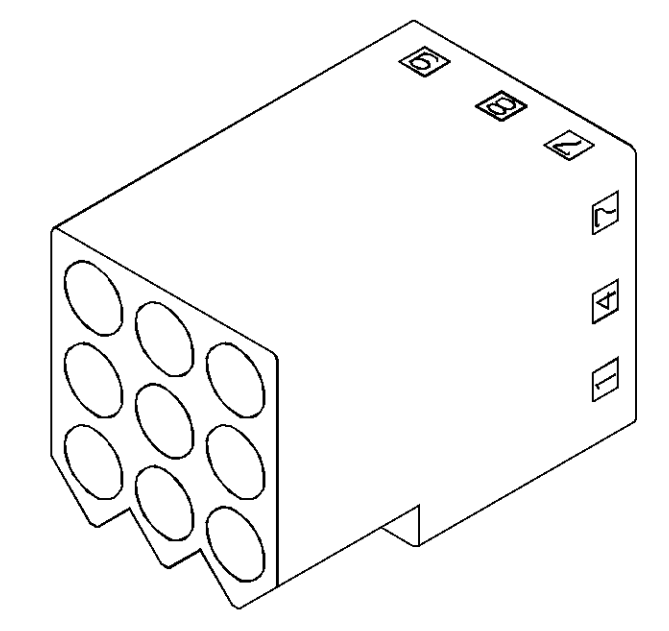

3D MODEL NTS

770094-1  
 PART NUMBER

**METRIC**

THIS DRAWING IS A CONTROLLED DOCUMENT.		DWN J. HUFFMAN	10-11-96	<b>AMP</b> AMP Incorporated Harrisburg, PA 17105-3608
		CHK R. SWING	10-11-96	
DIMENSIONS: INCHES		APVD C. CASH	10-16-96	NAME RECEPTACLE, 9 CIRCUIT .093 COMMERCIAL PIN & SOCKET
TOLERANCES UNLESS OTHERWISE SPECIFIED:		PRODUCT SPEC		APPLICATION SPEC
0 PLC	±-	APPLIC. SPEC		RESTRICTED TO
1 PLC	±-	WEIGHT		
2 PLC	±-	SIZE	A1	
3 PLC	±0.13	CARE CODE	770094	
4 PLC	±-	DRAWING NO	770094	
ANGLES	±-	SCALE	4:1	
FINISH	-	SHEET	1 OF 1	
		REV	E	