



# KitProg User Guide

Doc. # 001-96359 Rev. \*G

Cypress Semiconductor  
198 Champion Court  
San Jose, CA 95134-1709  
Phone (USA): 800.858.1810  
Phone (Intl): +1.408.943.2600  
[www.cypress.com](http://www.cypress.com)

## Copyrights

© Cypress Semiconductor Corporation, 2015. The information contained herein is subject to change without notice. Cypress Semiconductor Corporation assumes no responsibility for the use of any circuitry other than circuitry embodied in a Cypress product. Nor does it convey or imply any license under patent or other rights. Cypress products are not warranted nor intended to be used for medical, life support, life saving, critical control or safety applications, unless pursuant to an express written agreement with Cypress. Furthermore, Cypress does not authorize its products for use as critical components in life-support systems where a malfunction or failure may reasonably be expected to result in significant injury to the user. The inclusion of Cypress products in life-support systems application implies that the manufacturer assumes all risk of such use and in doing so indemnifies Cypress against all charges.

Any Source Code (software and/or firmware) is owned by Cypress Semiconductor Corporation (Cypress) and is protected by and subject to worldwide patent protection (United States and foreign), United States copyright laws and international treaty provisions. Cypress hereby grants to licensee a personal, non-exclusive, non-transferable license to copy, use, modify, create derivative works of, and compile the Cypress Source Code and derivative works for the sole purpose of creating custom software and or firmware in support of licensee product to be used only in conjunction with a Cypress integrated circuit as specified in the applicable agreement. Any reproduction, modification, translation, compilation, or representation of this Source Code except as specified above is prohibited without the express written permission of Cypress.

Disclaimer: CYPRESS MAKES NO WARRANTY OF ANY KIND, EXPRESS OR IMPLIED, WITH REGARD TO THIS MATERIAL, INCLUDING, BUT NOT LIMITED TO, THE IMPLIED WARRANTIES OF MERCHANTABILITY AND FITNESS FOR A PARTICULAR PURPOSE. Cypress reserves the right to make changes without further notice to the materials described herein. Cypress does not assume any liability arising out of the application or use of any product or circuit described herein. Cypress does not authorize its products for use as critical components in life-support systems where a malfunction or failure may reasonably be expected to result in significant injury to the user. The inclusion of Cypress' product in a life-support systems application implies that the manufacturer assumes all risk of such use and in doing so indemnifies Cypress against all charges.

Use may be limited by and subject to the applicable Cypress software license agreement.

PSoC Creator™ is a trademark and CapSense® and PSoC® are registered trademarks of Cypress Semiconductor Corporation. All other trademarks are the property of their respective owners.

## Flash Code Protection

Cypress products meet the specifications contained in their particular Cypress PSoC Datasheets. Cypress believes that its family of PSoC products is one of the most secure families of its kind on the market today, regardless of how they are used. There may be methods, unknown to Cypress, that can breach the code protection features. Any of these methods, to our knowledge, would be dishonest and possibly illegal. Neither Cypress nor any other semiconductor manufacturer can guarantee the security of their code. Code protection does not mean that we are guaranteeing the product as "unbreakable."

Cypress is willing to work with the customer who is concerned about the integrity of their code. Code protection is constantly evolving. We at Cypress are committed to continuously improving the code protection features of our products.

# Contents



<b>1. Introduction</b>	<b>4</b>
<b>2. KitProg Ecosystem</b>	<b>5</b>
<b>3. KitProg Programmer/Debugger</b>	<b>7</b>
3.1 Programming Using PSoC Creator .....	7
3.2 Debugging Using PSoC Creator .....	9
3.3 Programming Using PSoC Programmer .....	10
3.4 KitProg Driver Installation .....	11
3.5 Updating the KitProg Firmware.....	11
<b>4. KitProg Mass Storage Programmer</b>	<b>14</b>
4.1 Enter or Exit the Mass Storage Programmer Mode .....	14
4.2 Programming Using the Mass Storage Programmer .....	14
4.3 Frequently Asked Questions on KitProg Mass Storage Programmer.....	16
<b>5. KitProg USB-UART Bridge</b>	<b>18</b>
<b>6. KitProg USB-I2C Bridge</b>	<b>27</b>
<b>7. Developing Applications for PSoC 5LP</b>	<b>35</b>
7.1 Building a Bootloadable Project for PSoC 5LP .....	35
7.2 Building a Normal Project for PSoC 5LP .....	42
<b>8. Troubleshooting the KitProg</b>	<b>45</b>
8.1 KitProg Status LED Indication .....	45
8.2 PSoC 5LP Factory Program Restore Instructions .....	46
<b>Appendix</b>	<b>51</b>
<b>Revision History</b>	<b>53</b>

# 1. Introduction



The KitProg is an onboard programmer/debugger with USB-I2C and USB-UART bridge functionality. The KitProg is integrated onto most PSoC development kits. This user guide provides comprehensive information on how to use the KitProg functionalities with PSoC development kits. [Figure 1-1](#) shows the KitProg Ecosystem. The Cypress PSoC 5LP device is used to implement the KitProg functionality.

Figure 1-1. KitProg Ecosystem

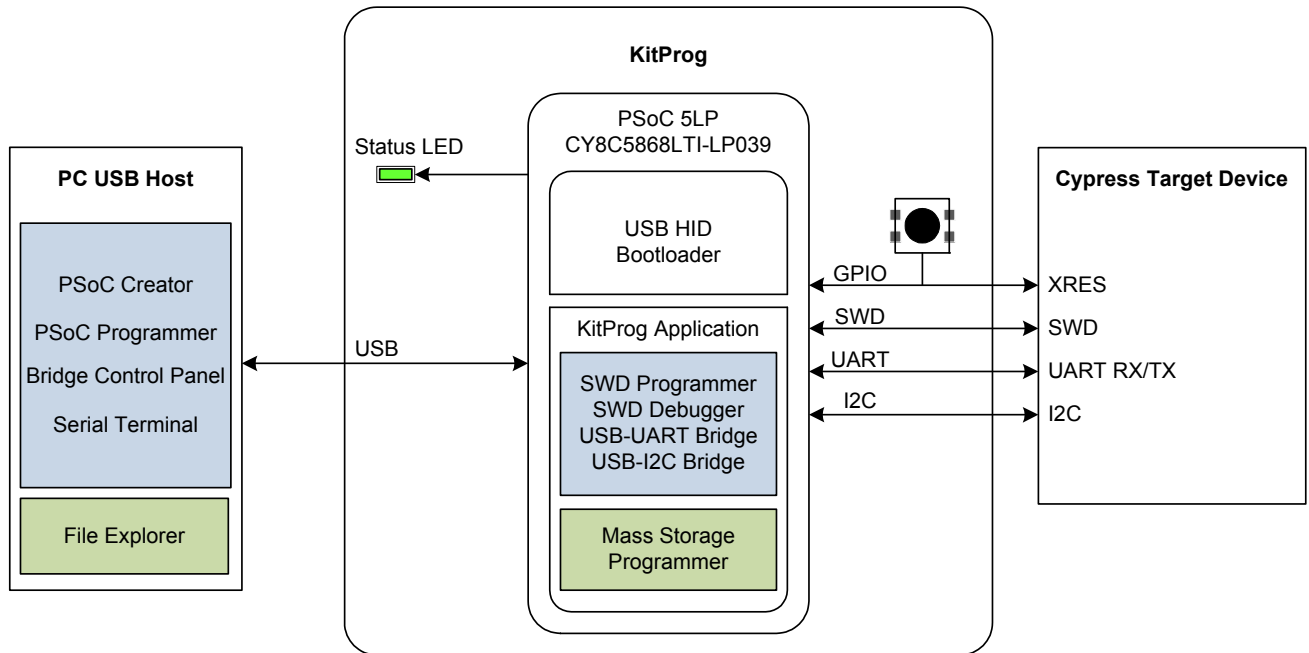

 Supported only on CY8CKIT-044 PSoC 4 M-Series Pioneer Kit

## 2. KitProg Ecosystem



Table 2-1 lists the development kits that use the KitProg. Table 2-2 lists the prerequisite Cypress software needed to use the KitProg.

Table 2-1. Development Kits Supported by KitProg

Functionality	Download Link/Remarks
<a href="#">CY8CKIT-042 PSoC 4 Pioneer Kit</a>	<a href="#">PSoC 4200</a>
<a href="#">CY8CKIT-040 PSoC 4000 Pioneer Kit</a>	<a href="#">PSoC 4000</a>
<a href="#">CY3280-MBR3 CapSense Evaluation Kit</a>	<a href="#">CapSense MBR3</a>
<a href="#">CY8CKIT-042-BLE Bluetooth Low Energy (BLE) Pioneer Kit</a>	<a href="#">PSoC 4200 BLE, PSoC BLE</a>
<a href="#">CY8CKIT-044 PSoC 4 M-Series Pioneer Kit</a>	<a href="#">PSoC 4200M</a>
<a href="#">CY8CKIT-043 PSoC 4 M-Series Prototyping Kit</a>	<a href="#">PSoC 4200M</a>
<a href="#">CY8CKIT-046 PSoC 4 L-Series Pioneer Kit</a>	<a href="#">PSoC 4200L</a>
<a href="#">CY8CKIT-059 PSoC 5LP Prototyping Kit</a>	<a href="#">PSoC 5LP</a>

The CY3280-MBR3 CapSense Evaluation Kit features a fixed-function CapSense controller device; the KitProg on this kit is only used for the USB-I2C bridge functionality. Therefore, except the chapter [6. KitProg USB-I2C Bridge on page 27](#), other chapters of this UG are not applicable to the CY3280-MBR3 kit.

Table 2-2. Prerequisite Software for KitProg Operation

Functionality	Pre-requisite Software	Download Link/Remarks
Programmer	PSoC Programmer	<a href="http://www.cypress.com/psocprogrammer">www.cypress.com/psocprogrammer</a>
Debugger	PSoC Creator	<a href="http://www.cypress.com/psoccreator">www.cypress.com/psoccreator</a>
USB-I2C Bridge	Bridge Control Panel (BCP)	Installed along with PSoC Programmer
USB-UART Bridge	Terminal Emulator Program	Any terminal emulator program can be used such as HyperTerminal (available as part of Microsoft Windows XP installation) or PuTTY (available from <a href="http://www.putty.org">www.putty.org</a> )

The KitProg supports different speeds for communication interfaces. [Table 2-3](#) summarizes the KitProg operating modes.

Table 2-3. KitProg Operating Modes

Functionality	Supported Speed	Units
Programmer	1.6	MHz
USB-I2C Bridge	50, 100, 400, 1000	kHz
USB-UART Bridge	1200, 2400, 4800, 9600, 19200, 38400, 57600, and 115200	Baud

This document assumes that you know the basics of how to use PSoC Creator™. If you are new to PSoC Creator, refer to the documentation in the [PSoC Creator home page](#). You can also refer to the following application notes to get started with PSoC devices:

- [Getting Started with PSoC® 4](#)
- [Getting Started with PSoC® 4 BLE](#)
- [Getting Started with PSoC® 5LP](#)
- [Getting Started with CapSense®](#)

## 3. KitProg Programmer/Debugger



This section explains the method to use the KitProg programmer/debugger integrated onto the PSoC development kits. The KitProg supports the development kits listed in [Table 2-1](#). This section uses the PSoC 4 M-Series Pioneer and PSoC 4 M-Series Prototyping Kit as examples.

### 3.1 Programming Using PSoC Creator

1. Connect the USB cable into the USB connector, J6, as shown in [Figure 3-1](#). If you are connecting the kit to your PC for the first time, it enumerates as a USB composite device and installs the required driver software. See the [3.4 KitProg Driver Installation on page 11](#) section for more information.

Figure 3-1. Connect USB Cable to J6 (Pioneer Kits)

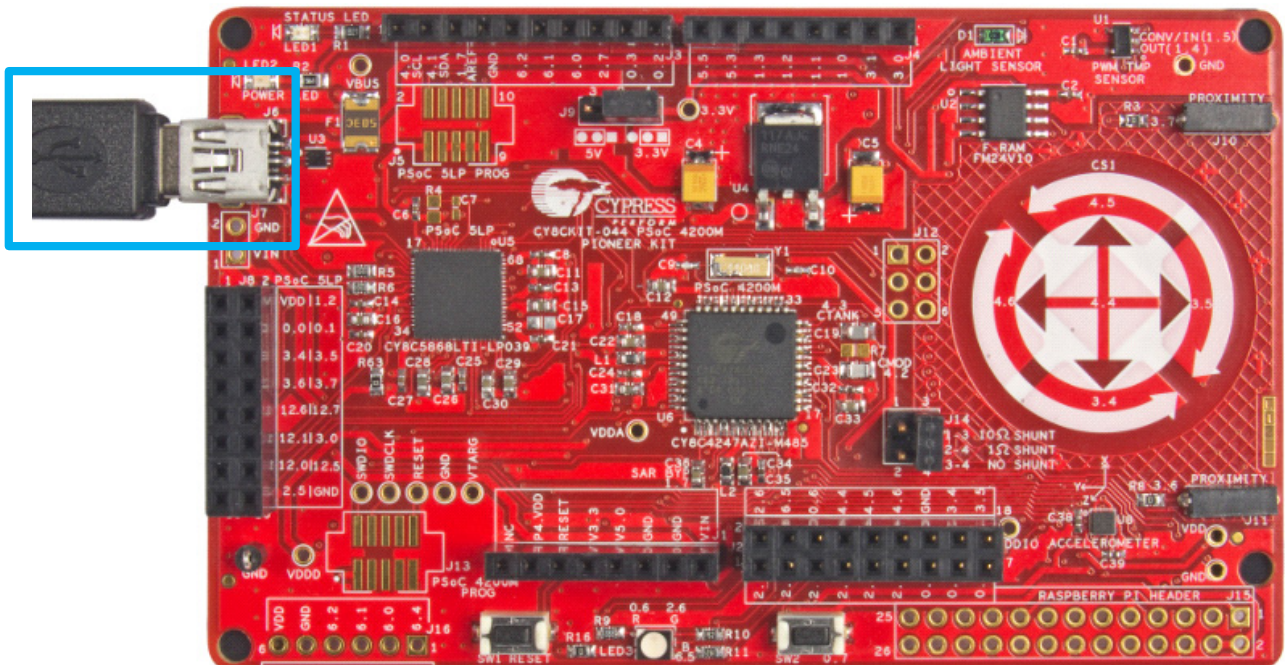
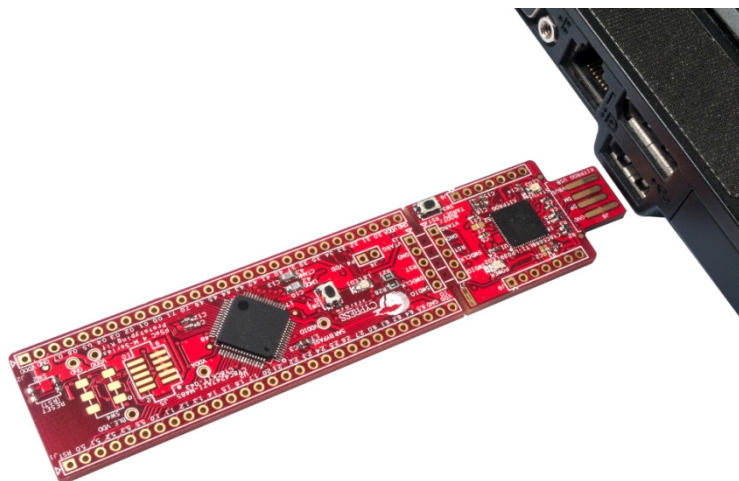
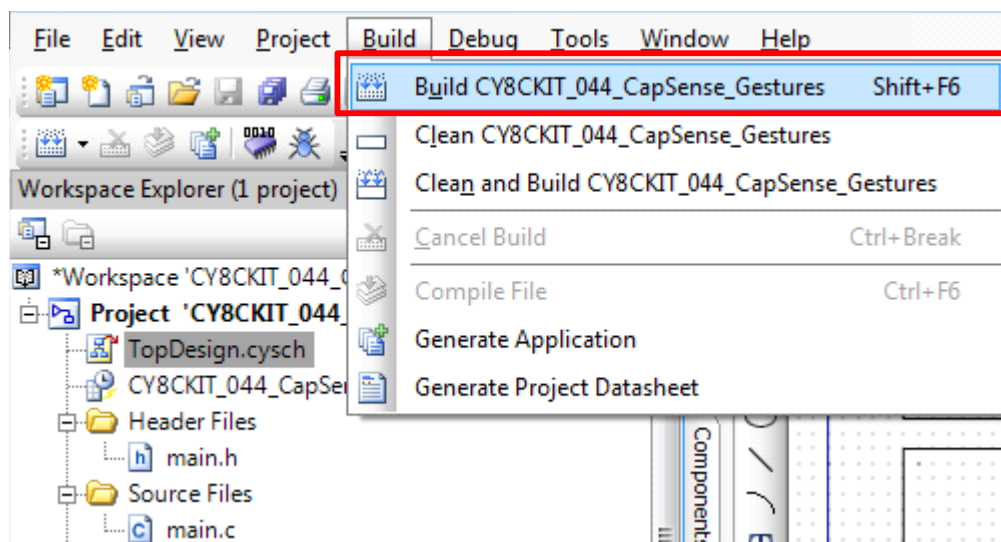

Figure 3-2. Connect USB Cable to J6 (Prototyping Kits)



2. Launch PSoC Creator from **Start > All Programs > Cypress > PSoC Creator <version> > PSoC Creator <version>**.
3. Select **File > Open > Project/Workspace** in PSoC Creator and browse to the desired project.
4. Select **Build > Build Project** or press **[Shift] [F6]** to build the project, as shown in [Figure 3-3](#).

Figure 3-3. Build an Example Project



5. If there are no errors during build, program the PSoC 4200M device on the kit by choosing **Debug > Program** or pressing **[Ctrl] [F5]**, as shown in [Figure 3-4](#).



Figure 3-4. Programming Device from PSoC Creator

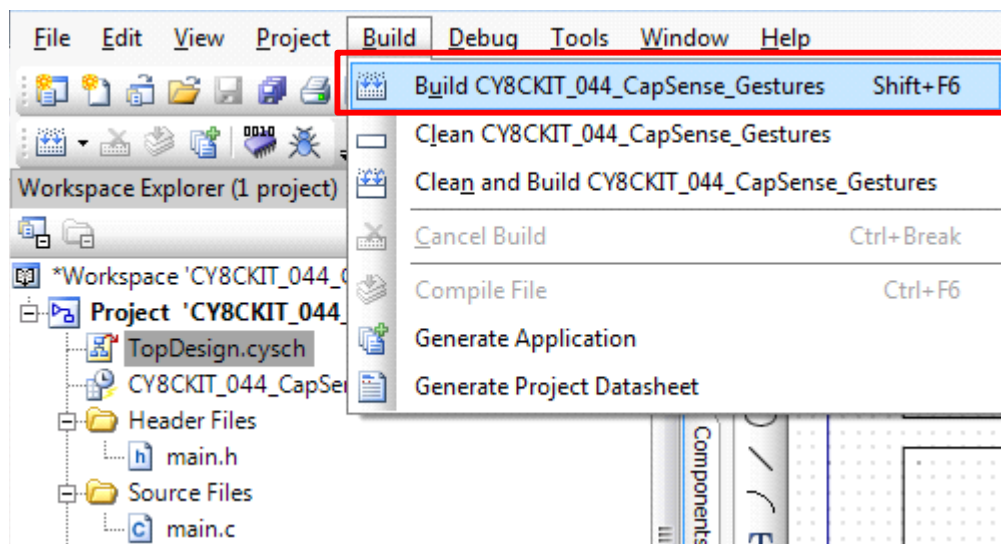

### 3.2 Debugging Using PSoC Creator

To debug the project using PSoC Creator, follow steps 1 to 4 from [3.1 Programming Using PSoC Creator on page 7](#). Then, follow these steps:

1. Click the **Debug** icon or press **[F5]**, as shown in [Figure 3-5](#). Alternately, you can select **Debug > Debug**. This programs the device and starts the debugger.

Figure 3-5. Debug Option in PSoC Creator

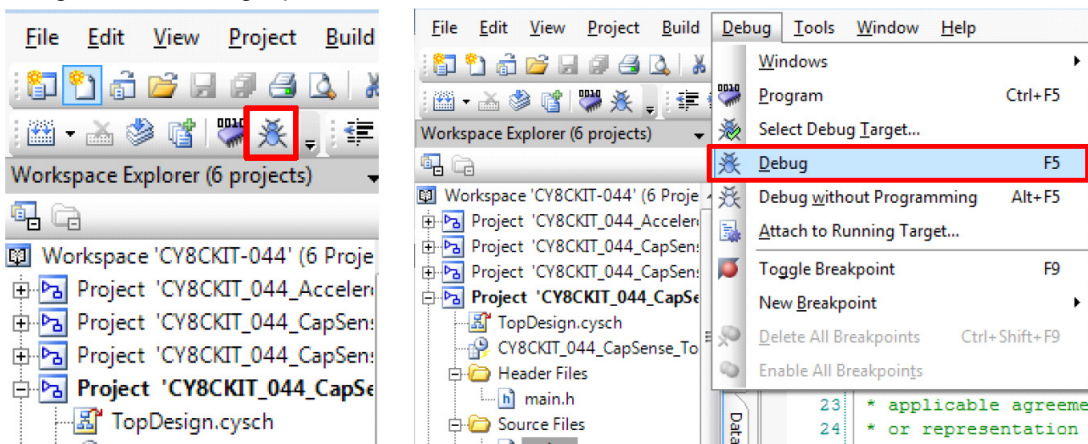

2. When PSoC Creator enters the Debug mode, use the buttons on the toolbar or keyboard shortcuts to debug your project.

For more details on using the debug features, refer to the PSoC Creator Help. Select **Help > PSoC Creator Help Topics** in the PSoC Creator menu. In the PSoC Creator Help window, locate **Using the Debugger** section in the **Contents** tab, as shown in [Figure 3-6](#).

Figure 3-6. Using the PSoC Creator Debugger

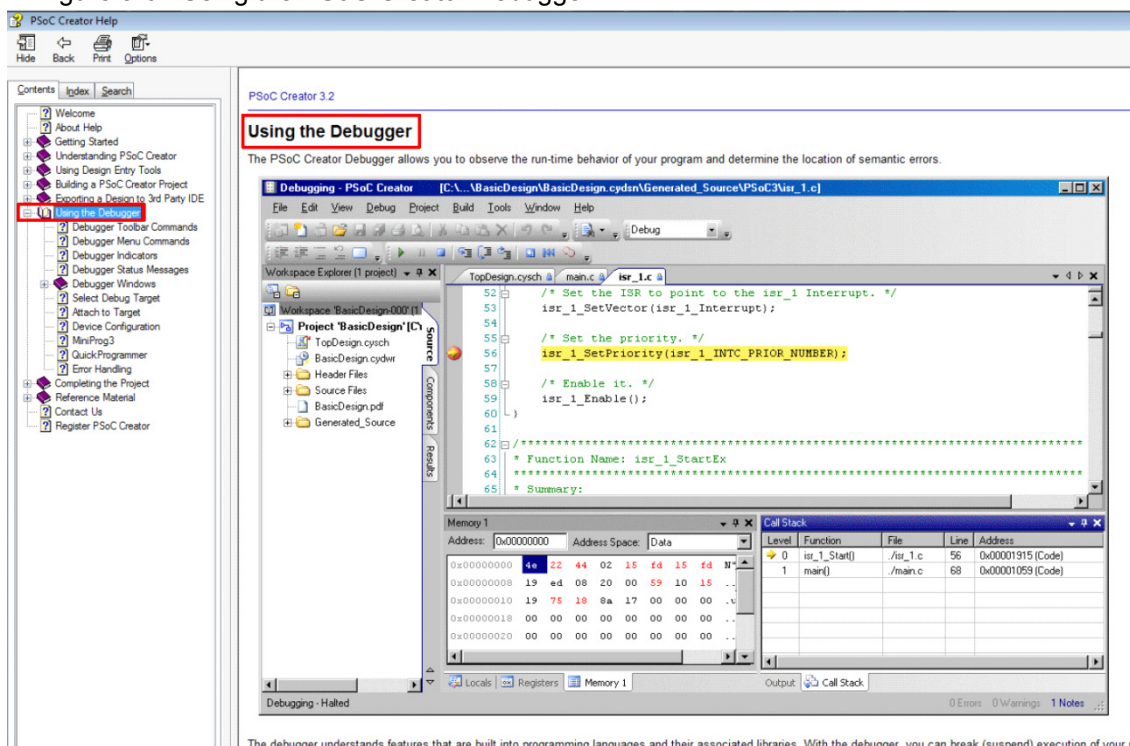

### 3.3 Programming Using PSoC Programmer

PSoC Programmer (3.22.2 or later) can be used to program existing `.hex` files into the kit. To do this, follow these steps.

1. Connect the kit to your PC and open PSoC Programmer from **Start > All Programs > Cypress > PSoC Programmer <version> > PSoC Programmer <version>**.
2. Click the **File Load** button at the top left corner of the window. Browse to the desired `.hex` file and click **Open**. For the PSoC 4 device, the `.hex` file is located at: `<Project Directory>\<Project Name.cydsn>\CortexM0\ <Compiler Name and Version>\<Debug> or <Release>\<Project Name.hex>`.
3. Click the **KitProg/<serial number>** in the **Port Selection** list to connect the kit to your computer.

**Note:** If the CY5670 CySmart USB Dongle (BLE Dongle) is used, the device will enumerate as **KitProg/BLE<serial number>**.

4. Click the **Program** button to start programming the kit with the selected file.

**Note:** If the `.hex` file does not match the selected device, then PSoC Programmer will display a device mismatch error and terminate programming. Ensure that you have selected the correct `.hex` file.

5. When the programming is completed successfully, indicated by a **PASS** message on the status bar, the kit is ready for use. Close PSoC Programmer.

### 3.4 KitProg Driver Installation

The kits are powered from a computer over the USB interface. It enumerates as a composite device, as shown in [Table 3-1](#). The USB drivers required for enumeration are part of the kit installer and should be appropriately installed for its correct operation.

Table 3-1. Enumerated Interfaces

Function	Description
USB Composite Device	USB Composite device
USB Input Device	USB-I2C bridge, KitProg command interface
KitProg	Programmer and debugger
KitProg USB-UART	USB-UART bridge, which appears as the COM# port

Figure 3-7. KitProg Driver Installation (appearance may differ depending on the Windows version)

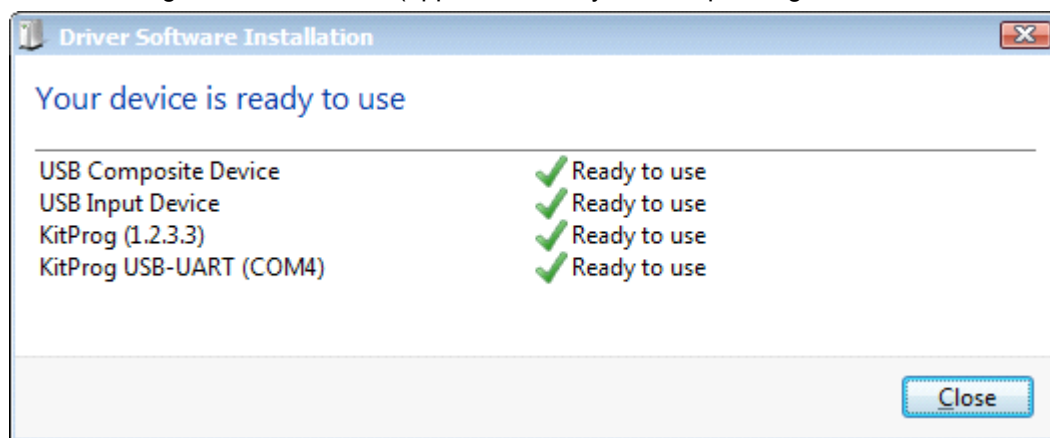

### 3.5 Updating the KitProg Firmware

The KitProg firmware generally does not require any update. If an update is required, then PSoC Programmer will display a warning message when the kit is connected to it, as shown in [Figure 3-8](#).

Figure 3-8. KitProg Firmware Update Warning

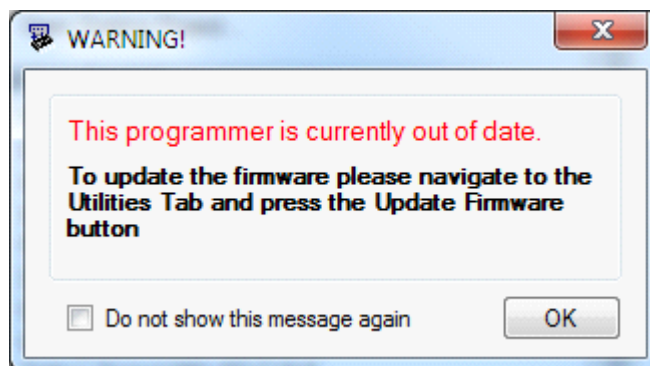

Click **OK** to close the window. On closing the warning window, the Actions and Results window displays: "Please navigate to the Utilities tab and click the Upgrade Firmware button", as shown in [Figure 3-9](#).

To update the KitProg, go to the **Utilities** tab on PSoC Programmer and click **Upgrade Firmware**, as shown in [Figure 3-9](#).

Figure 3-9. Upgrade Firmware in PSoC Programmer

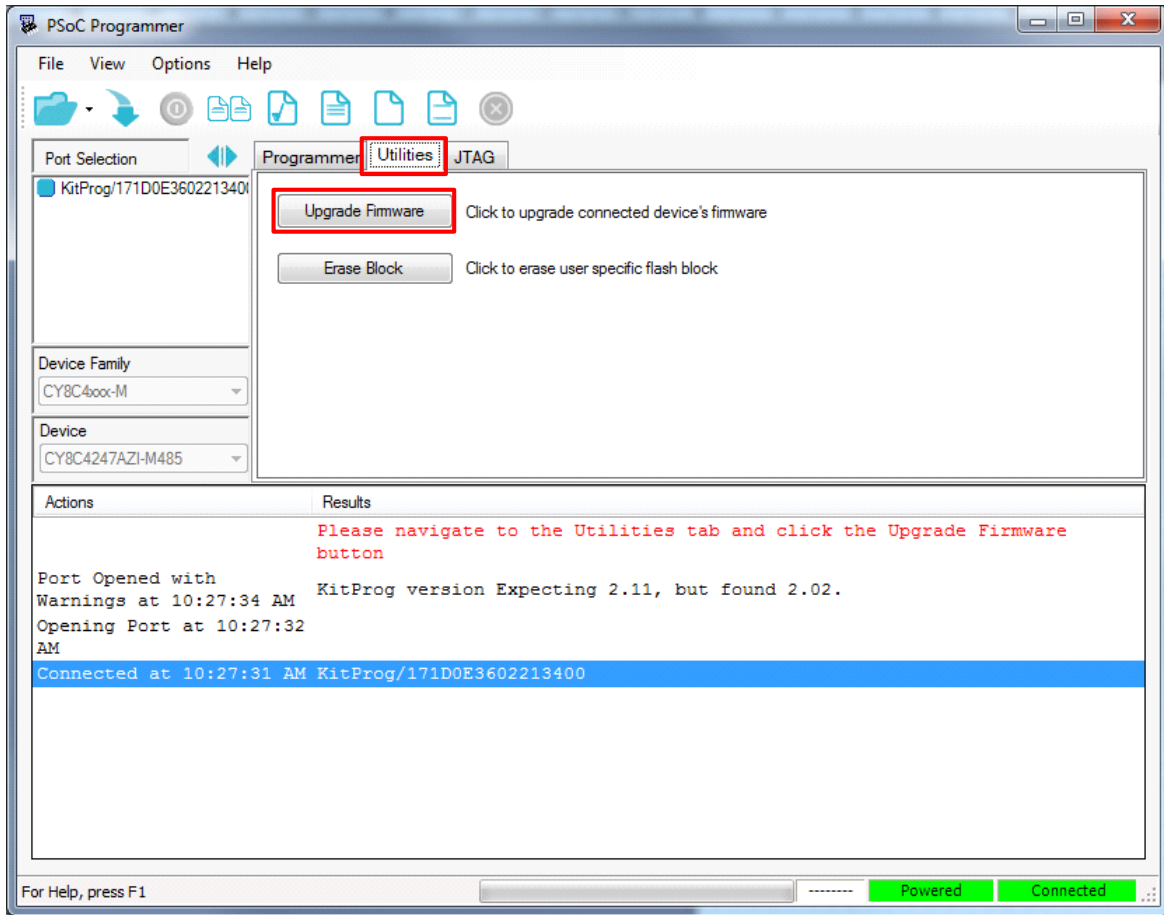

On successful upgrade, the Actions and Results window displays the firmware update message with the KitProg version, as shown in [Figure 3-10](#).

Figure 3-10. Firmware Updated in PSoC Programmer

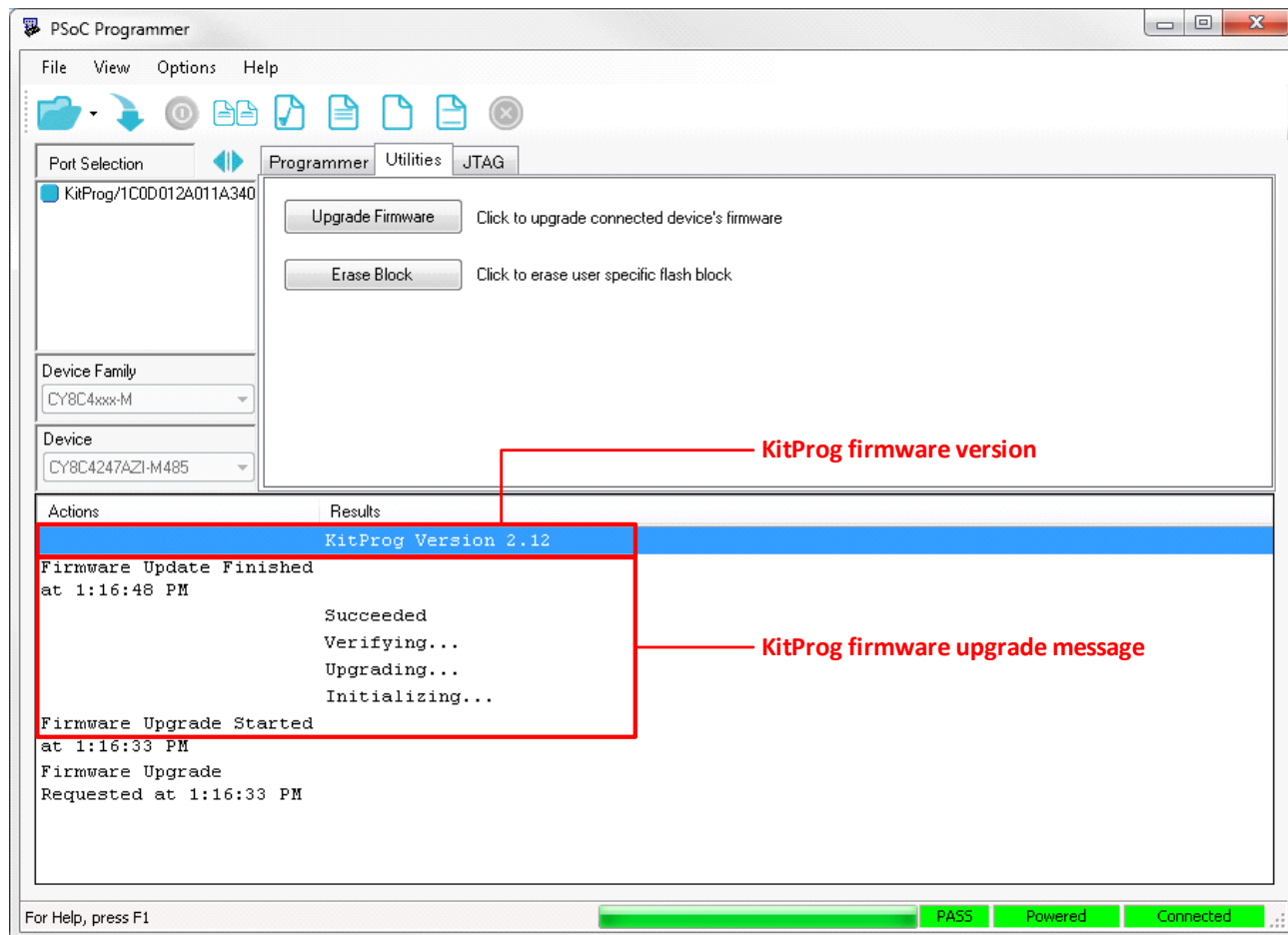

## 4. KitProg Mass Storage Programmer



The KitProg can act as a USB Mass Storage Programmer. This is an alternate configuration of KitProg which is currently available only in CY8CKIT-044 PSoC 4 M-Series Pioneer Kit. The KitProg Programmer and Debugger, KitProg USB-I2C Bridge, and KitProg USB-UART Bridge functionalities are not available in this configuration.

**Note:** KitProg version 2.12 or higher is required to enable Mass Storage Programmer configuration. You can upgrade the KitProg version through the PSoC Programmer.

Visit [www.cypress.com/psocprogrammer](http://www.cypress.com/psocprogrammer) to download the latest version of the PSoC Programmer.

### 4.1 Enter or Exit the Mass Storage Programmer Mode

Follow these steps to enter or exit the Mass Storage Programmer mode of KitProg:

1. Connect the kit to the PC. Ensure that the Status LED is on and not blinking. Refer to the section [8.1 KitProg Status LED Indication on page 45](#) for details on the Status LED indications.
2. Press and hold the reset switch (**SW1**) of the kit for more than 5 seconds. The Status LED of the kit turns off when the KitProg changes configurations.
3. Release the reset switch on the kit after Status LED has turned off. The KitProg re-enumerates in the alternate configuration. For example, the kit enumerates as Mass Storage Programmer if the previous configuration is KitProg Programmer and Debugger.

**Note:** The KitProg remains in the selected mode until the user changes the mode manually using the above steps.

### 4.2 Programming Using the Mass Storage Programmer

Follow these steps to program the target device using the Mass Storage Programmer:

1. Enter the Mass Storage Programmer mode as explained in the section [4.1 Enter or Exit the Mass Storage Programmer Mode](#). The KitProg is visible as a removable disk drive in the file explorer of the PC, as shown in [Figure 4-1](#).

Figure 4-1. KitProg Emulated as Mass Storage Device

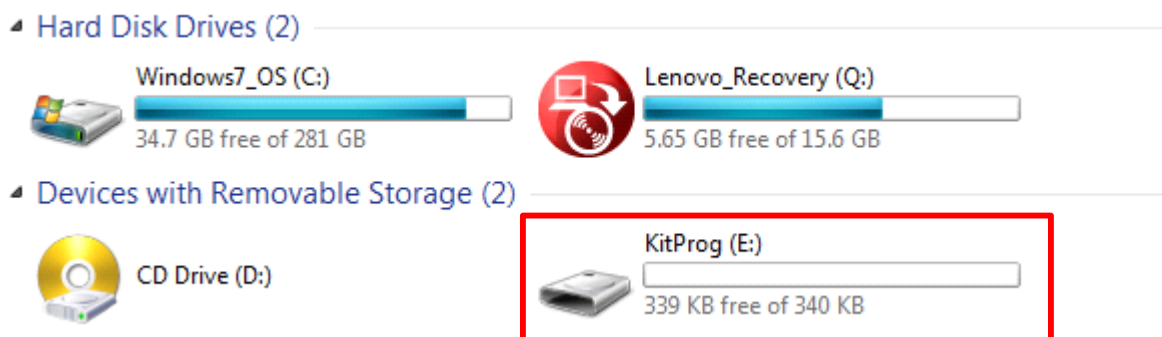

- Open the KitProg Drive to view the *STATUS.TXT* file, as shown in [Figure 4-2](#). Note that the file extension *.TXT* is visible for the file, if it is enabled in your PC settings. The *STATUS.TXT* shows the current status of the Mass Storage Programmer.

Figure 4-2. *STATUS.TXT* in the KitProg Drive

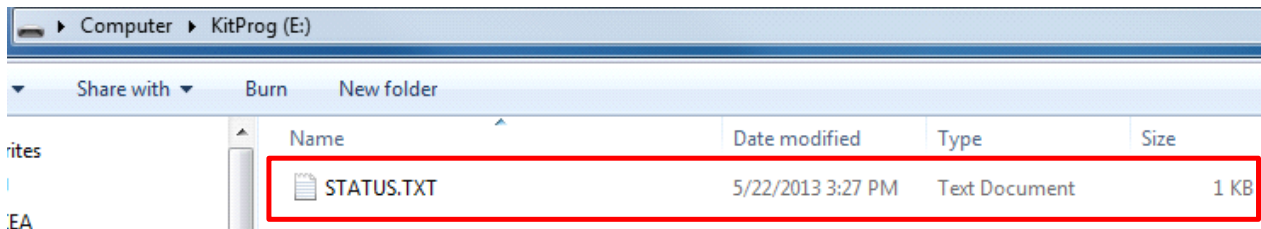

- Copy any PSoC 4200M device based project *.hex* file to the KitProg Drive to begin programming. Alternately, you can also drag and drop the *.hex* file on to the drive. The *.hex* file is available in the following path:

`<Project Directory>\<Project Name.cydsn>\CortexM0\<Compiler Name and Version>\<Debug> or <Release>\<Project Name.hex>`

Figure 4-3. Copy the *.hex* File to KitProg Drive

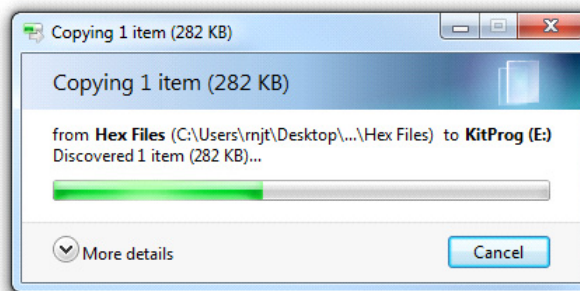
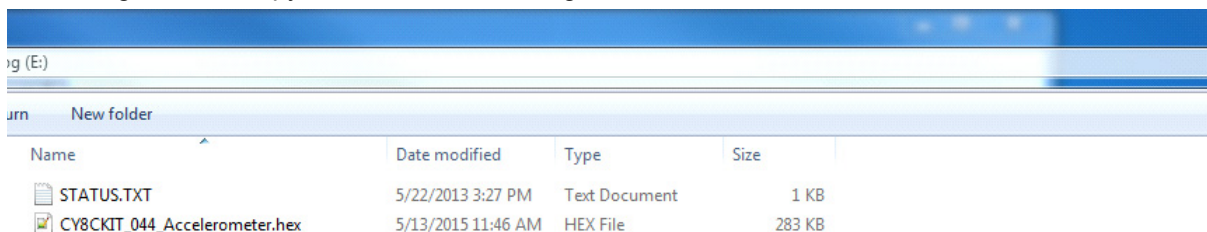

- The Status LED on the kit blinks during the programming operation. The Status LED continues to blink for 2 seconds after the programming operation and the KitProg Drive automatically removes the copied file from the drive. Press **F5** in the file explorer to refresh the contents of the drive. This will display only the *STATUS.TXT* file in the KitProg Drive.

5. Open the *STATUS.TXT* file to view the status of the programming operation, as shown in [Figure 4-4](#).

Figure 4-4. Status Displayed in the KitProg Drive after Programming

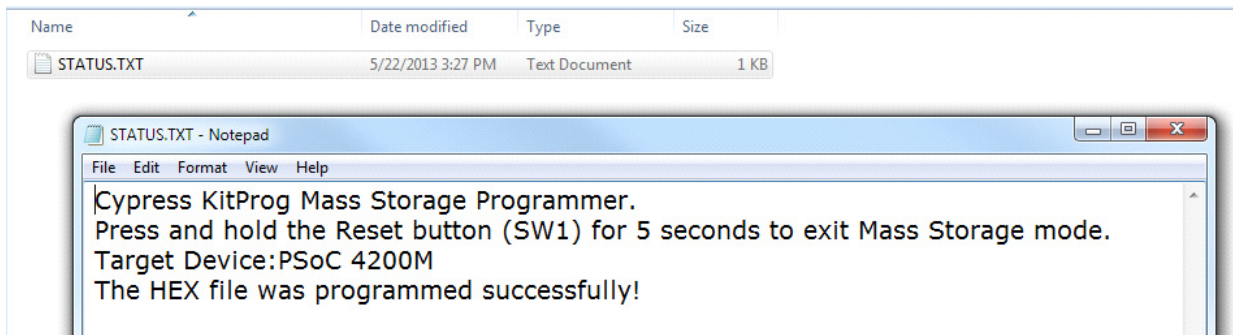



## 4.3 Frequently Asked Questions on KitProg Mass Storage Programmer

1. What are the Cypress kits supported by the KitProg Mass Storage Programmer?

The KitProg Mass Storage Programmer currently supports only CY8CKIT-044 PSoC 4 M-Series Pioneer Kit.

2. What are the operating systems supported by KitProg Mass Storage Programmer?

The KitProg Mass Storage Programmer works on Microsoft Windows and Apple Mac Operating Systems. The KitProg Mass Storage Programmer is currently not supported on Linux Operating System.

3. Why are the contents of F-RAM removed and filled with random values after programming operation?

The KitProg Mass Storage Programmer uses the on-board F-RAM of the CY8CKIT-044 PSoC 4 M-Series Pioneer Kit to store the contents of the copied .hex file for programming operation. This is the reason for removal of any stored data.

4. What happens if I copy an incorrect .hex file to the KitProg Drive?

If you copy a PSoC 4200M .hex file with invalid data (incorrect Silicon ID, incorrect Checksum, and so on), the KitProg Mass Storage Programmer attempts a programming operation and generates an error indicating which step of the programming operation has failed in the *STATUS.TXT* file.

If you copy a .hex file which corresponds to any other device, the KitProg Mass Storage Programmer does not attempt a programming operation and generates an error indicating that the copied file is not a valid .hex file in the *STATUS.TXT* file.

If you copy any other file than specified above and file size does not exceed the KitProg Drive size, the file will be visible in the KitProg Drive until the KitProg Drive is removed from the PC. Note that the file is not actually copied to the KitProg Drive. Delete these files before attempting to program a new .hex file.

5. Why does my Operating System display the pop-up “Disk Not Ejected Properly” after every programming operation in KitProg Mass Storage Programmer mode?

The KitProg Mass Storage Programmer temporarily ejects 2 seconds after the programming operation. This can also cause the file explorer window of the KitProg Drive to close after programming operation in some operating systems.

6. Is it possible to program an external PSoC other than PSoC 4200M using the KitProg Mass Storage Programmer?

No. The KitProg Mass Storage Programmer supports only PSoC 4200M on the CY8CKIT-044 PSoC 4 M-Series Pioneer Kit.

7. Can I use .hex files generated by any other IDE other than PSoC Creator to program the PSoC 4200M using KitProg Mass Storage Programmer?

Yes. You can also use the .hex file generated for PSoC 4200M by an external IDE such as Eclipse, IAR, Keil  $\mu$ Vision that supports PSoC 4 devices, to program the PSoC 4200M using KitProg Mass Storage Programmer.

8. Why does the programming time for different files vary?

The KitProg Mass Storage Programmer intelligently programs only the flash rows with non-zero data. Depending on the contents of your project, the programming time may take up to 20 seconds.

## 5. KitProg USB-UART Bridge



The KitProg can act as a USB-UART bridge. This feature of the KitProg is useful to send and receive data between the Cypress device on the kit and the PC. For example, in the PSoC 4 M-Series Pioneer Kit, the KitProg USB-UART can be used to print debug messages on COM terminal software running on the PC.

This section explains a method to create a PSoC 4 code example, which communicates with the COM terminal software using the KitProg USB-UART Bridge. This example uses Windows HyperTerminal as the COM terminal software. If you have a Windows operating system that does not have HyperTerminal, use alternate terminal software such as [PuTTY](#).

1. Create a new PSoC 4 project in PSoC Creator, as shown in [Figure 5-1](#). Select a specific location for your project and name the project as desired. You must select the appropriate device for this project depending on the kit as provided in [Table 2-1](#). Ensure that the Project template option is set to Empty schematic. This example uses PSoC 4200M as the target device and PSoC 4 M-Series Pioneer Kit as the target board.

Figure 5-1. Create New Project in PSoC Creator

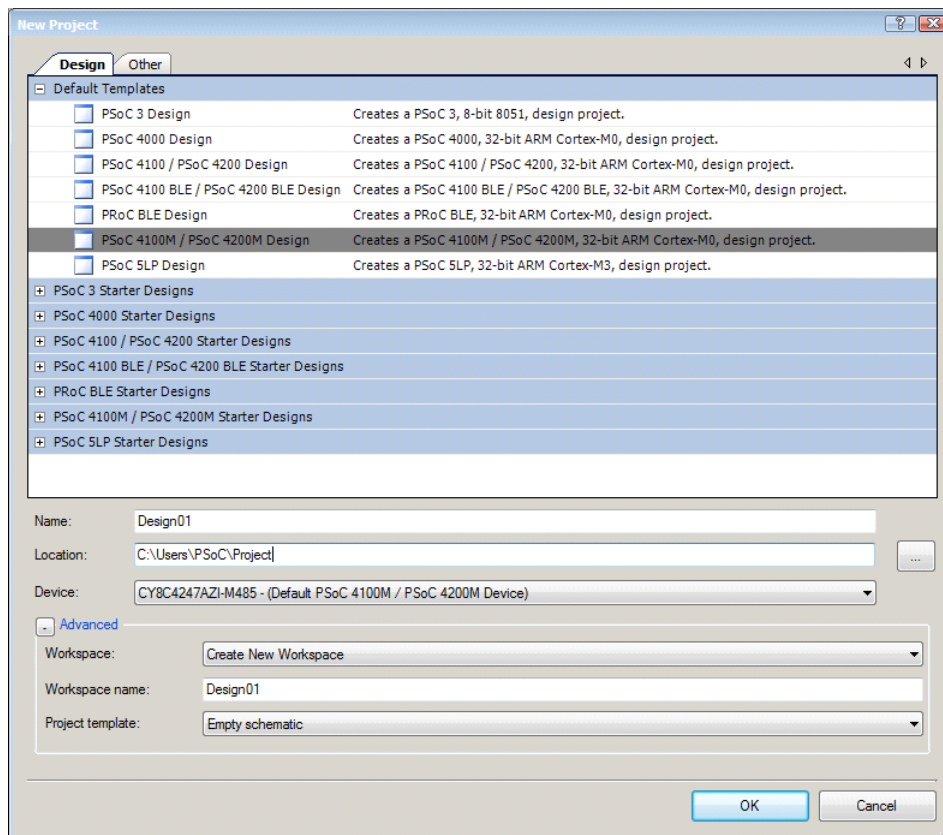

2. Drag and drop a UART (SCB mode) Component from the Component Catalog (see [Figure 5-2](#)) to the TopDesign. The Component Catalog is located along the right side of the PSoC Creator window by default. To configure the UART, double-click or right-click the UART Component and select **Configure**, as shown in [Figure 5-3](#).

Figure 5-2. UART Component in Component Catalog

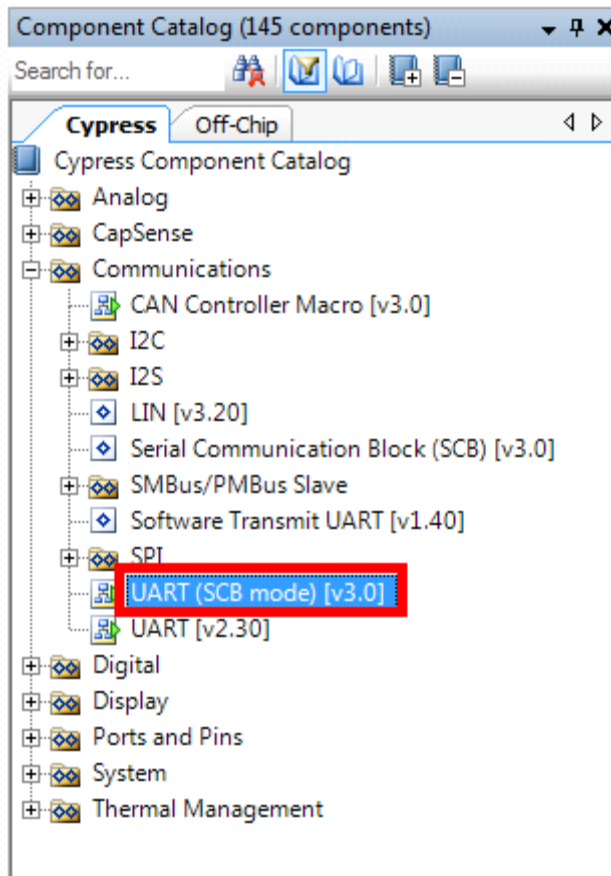
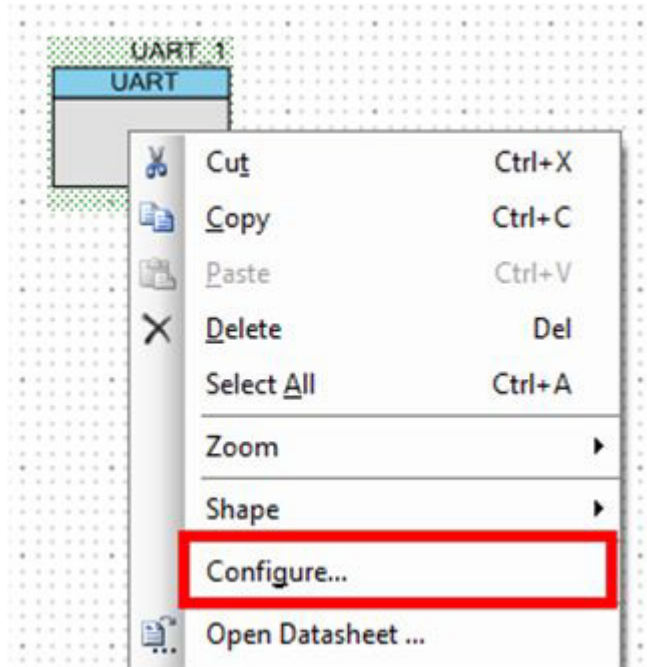

Figure 5-3. Open UART Configuration Window



3. Configure the UART Component as shown in [Figure 5-4](#), [Figure 5-5](#) and [Figure 5-6](#), and then click **OK**.

Figure 5-4. UART Configuration Tab Window

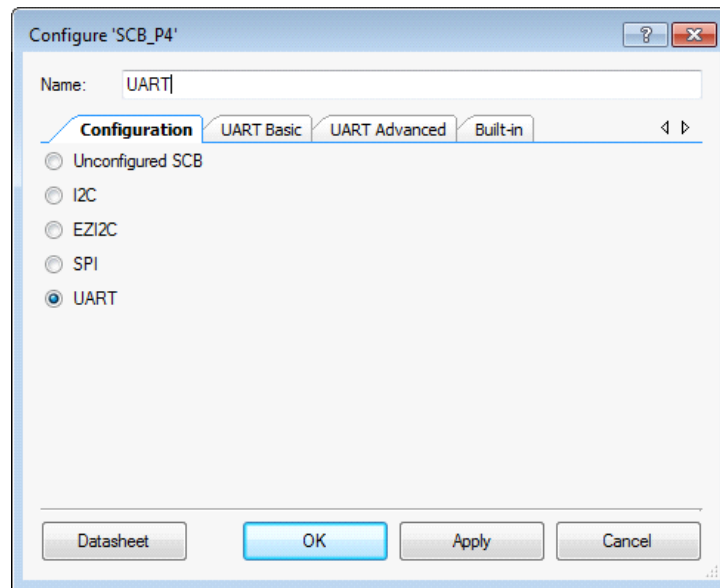

Figure 5-5. UART Basic Tab Window

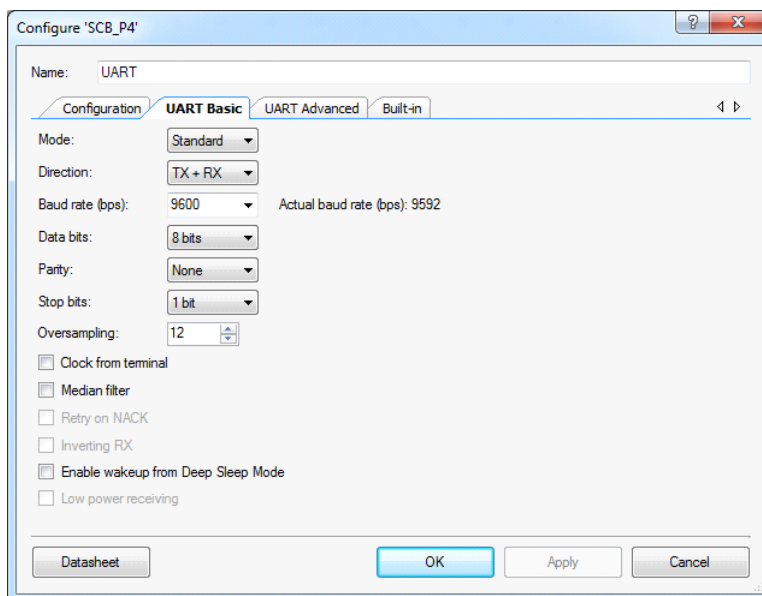
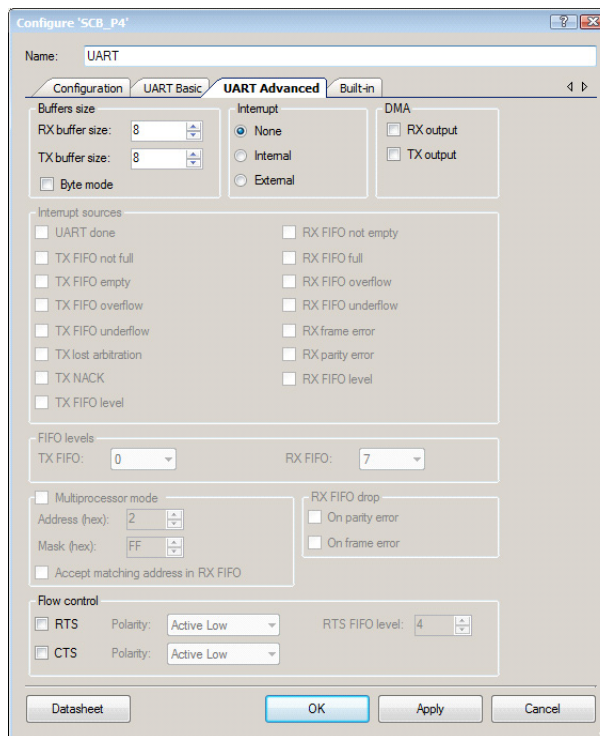

Figure 5-6. UART Advanced Tab Configuration Window



4. Select P7[0] for UART RX and P7[1] for UART TX in the **Pins** tab of `<Project_Name>.cydwr`, as shown in Figure 5-7. The file `<Project_Name>.cydwr` can be found in the Workspace Explorer window, which is located along the left side of the PSoC Creator window by default. Double-click on the file to open it. Note that these are the pins for the USB-UART interface on the PSoC 4 M-Series Pioneer kit. If you are using a different kit, refer to the respective Kit Guide for the appropriate pins.

Figure 5-7. Pin Selection

Alias	Name /	Port	Pin	Lock
\UART:rx\	P7[0] TCPWM0:line_out, SCB3:uart_rx, SCB3:i2c scl, SCB3:spi mosi		37	<input checked="" type="checkbox"/>
\UART:tx\	P7[1] TCPWM0:line_out_compl, SCB3:uart_tx, SCB3:i2c sda, SCB3:spi miso		38	<input checked="" type="checkbox"/>

5. Place the following code in the *main.c* file. The code echoes any data received through UART.

**Note:** The *main.c* file can be found on the Workspace Explorer window, which is located along the left side of the PSoC Creator window by default. Double-click on the file to open it.

```
#include <project.h>
int main()
{
    uint8 ch;
    /* Start SCB UART TX+RX operation */

    UART_Start();
    /* Transmit String through UART TX Line */

    UART_UartPutString("CY8CKIT-044 USB-UART");
    for(;;)
    {
        /* Get received character or zero if nothing has been
        received yet */
        ch = UART_UartGetChar();
        if(0u != ch)
        {
            /* Send the data through UART. This functions is
            blocking and waits until there is an entry into the TX
            FIFO. */
            UART_UartPutChar(ch);
        }
    }
}
```

6. Build the project by choosing **Build > Build [Project Name]** or pressing **[Shift] [F6]**. After the project is built without errors and warnings, program the project (by choosing **Debug > Program**) to the PSoC 4200M using KitProg.

**Note:** UART RX and UART TX can be routed to any digital pin on PSoC 4 by using the UDB implementation of the UART Component. In this case, we are using the SCB implementation of the UART, which routes the pins to one of the specific set of pins supported by the device. This will vary depending on the PSoC 4 device used.

To communicate with the PSoC 4200M device from the terminal software, follow this procedure:

1. Connect the USB Mini-B cable to J6. The kit enumerates as a **KitProg USB-UART**, and is available in the **Device Manager** under **Ports (COM & LPT)**. A communication port is assigned to the **KitProg USB-UART**, as shown in [Figure 5-8](#).

Figure 5-8. KitProg USB-UART in Device Manager

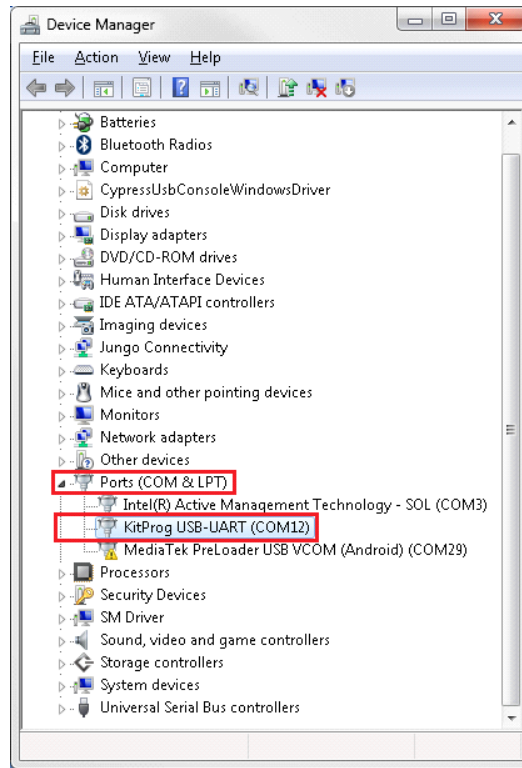

2. Open HyperTerminal, choose **File > New Connection**, enter a name for the new connection, and then click **OK** as shown in [Figure 5-9](#). For PuTTY, double-click the PuTTY application and select **Serial** under **Category**.

Figure 5-9. Open New Connection

**HyperTerminal**

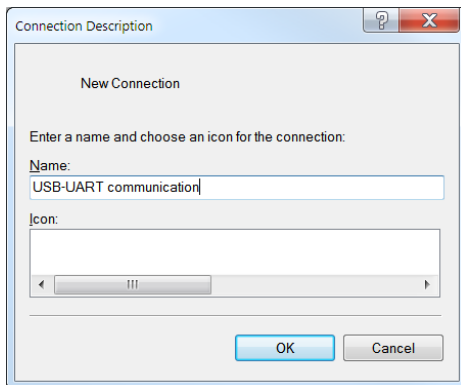

**PuTTY**

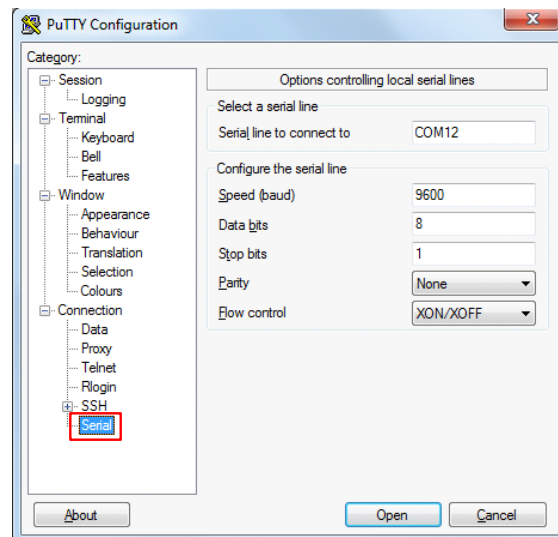

3. A new window opens, where the communication port can be selected. In HyperTerminal, select COMx (the specific communication port that is assigned to the KitProg USB-UART) in **Connect using** and click **OK**, as shown in [Figure 5-10](#).

In PuTTY, enter the COMx in **Serial line to connect to**. This example uses COM12.

Figure 5-10. Select Communication Port

**HyperTerminal**



**PuTTY**

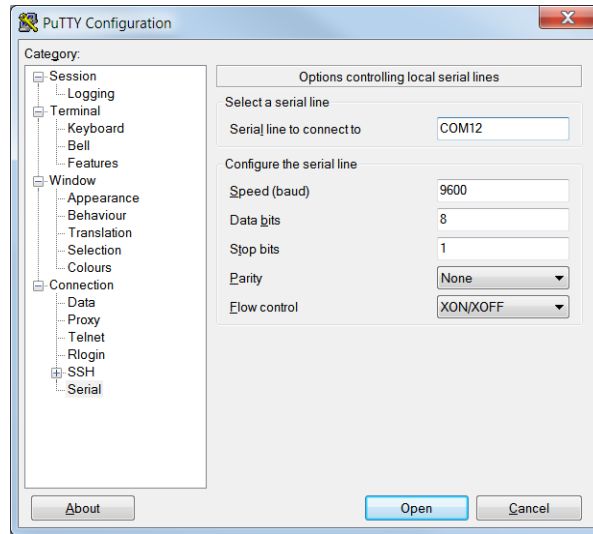

4. In HyperTerminal, select **Bits per second**, **Data bits**, **Parity**, **Stop bits**, and **Flow control** under **Port Settings** and click **OK** (see [Figure 5-11](#)). Ensure that the settings are identical to the UART settings configured for the PSoC 4200M device.

In PuTTY, enter the **Speed (baud)**, **Data bits**, **Stop bits**, **Parity**, and **Flow control** under **Configure the serial line**.

Figure 5-11. Configure the Communication Port

**HyperTerminal**

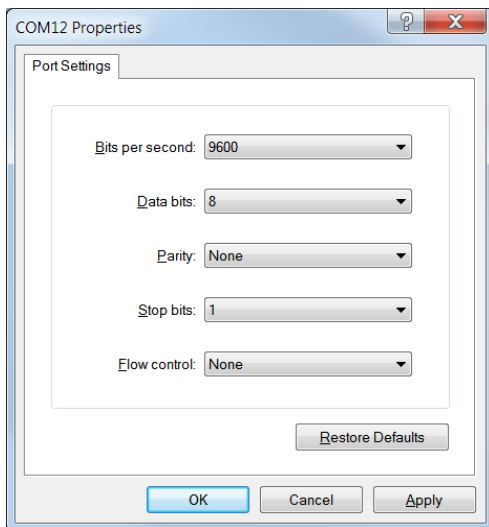

**PuTTY**

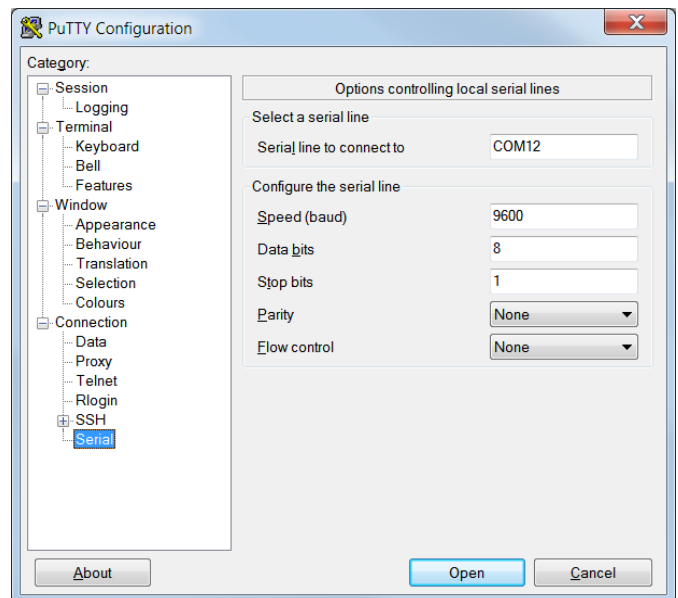



5. Enable **Echo typed characters** locally under **File > Properties > Settings > ASCII Setup** to display the typed characters on HyperTerminal, as shown in [Figure 5-12](#). In PuTTY, select **Force on** under **Terminal > Line discipline options** to display the typed characters on PuTTY, as shown in [Figure 5-12](#).

Figure 5-12. Enable Echo of Typed Characters in HyperTerminal and PuTTY

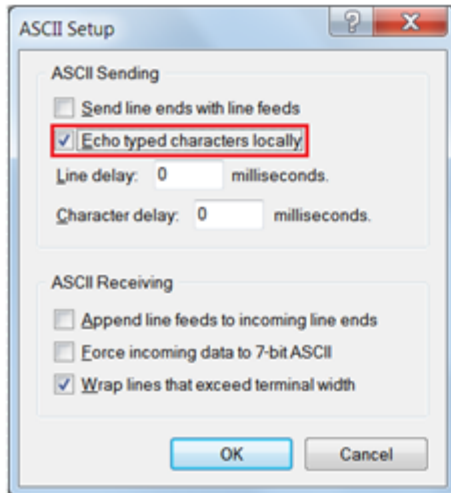
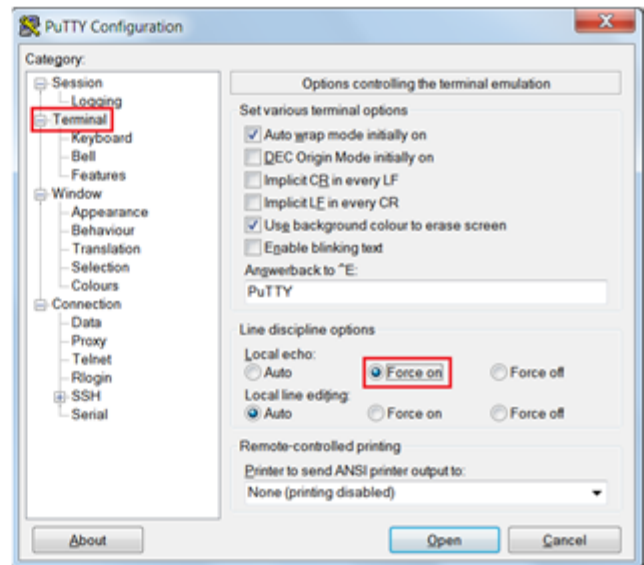
**HyperTerminal**

**PuTTY**

6. In PuTTY, click **Session** and select **Serial** under **Connection type**. Serial line shows the communication port (COM12) and **Speed** shows the baud rate selected. Click **Open** to start the communication, as shown in [Figure 5-13](#).

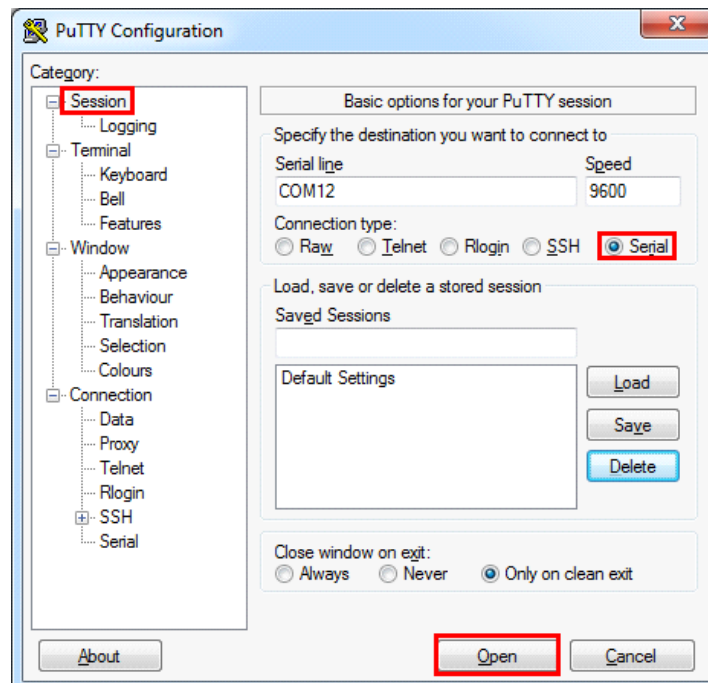
Figure 5-13. Opening Port in PuTTY



7. The COM terminal software displays both the typed data and the echoed data from the PSoC 4200M UART, as shown in [Figure 5-14](#).

Figure 5-14. Data Displayed on HyperTerminal and PuTTY

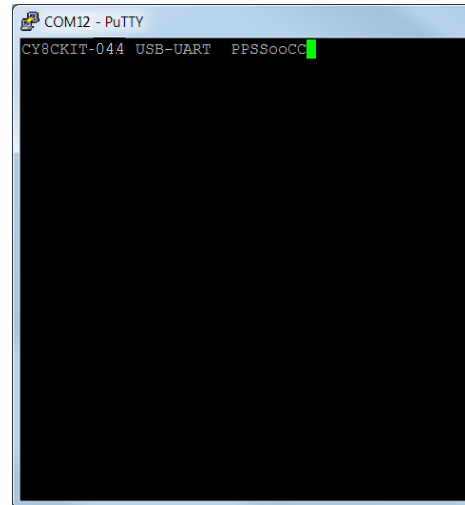
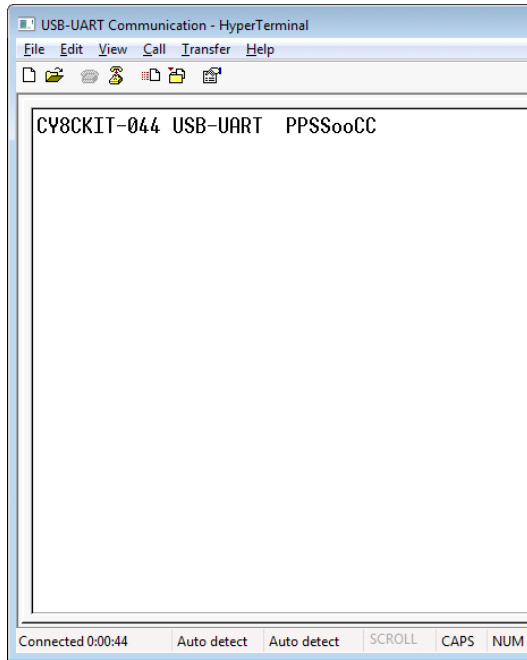

## 6. KitProg USB-I2C Bridge



The KitProg serves as a USB-I2C bridge that can be used to communicate with the USB-I2C software running on the PC. For example, the KitProg USB-I2C Bridge can be used to tune the CapSense Component on a PSoC device. This feature is applicable to all kits listed in [Table 2-1](#). This section uses the PSoC 4 M-Series Pioneer Kit as an example to demonstrate the KitProg USB-I2C Bridge functionality. The following steps describe how to use the USB-I2C Bridge, which can communicate between the Bridge Control Panel (BCP) software and the PSoC 4200M device.

**Note:** For information on how to use the KitProg USB-I2C Bridge to tune the CapSense Component, refer to Section 5.2.2 **Manual Tuning Process** in [AN85951 - PSoC 4 CapSense Design Guide](#).

1. Create a new PSoC 4 project in PSoC Creator, as shown in [Figure 6-1](#). Select a specific location for your project and name the project as desired. You must select the appropriate device for this project depending on the kit, as provided in [Table 2-1](#). Ensure that the option Project template is set to Empty schematic. This example uses PSoC 4200M as the target device.

Figure 6-1. Create New Project in PSoC Creator

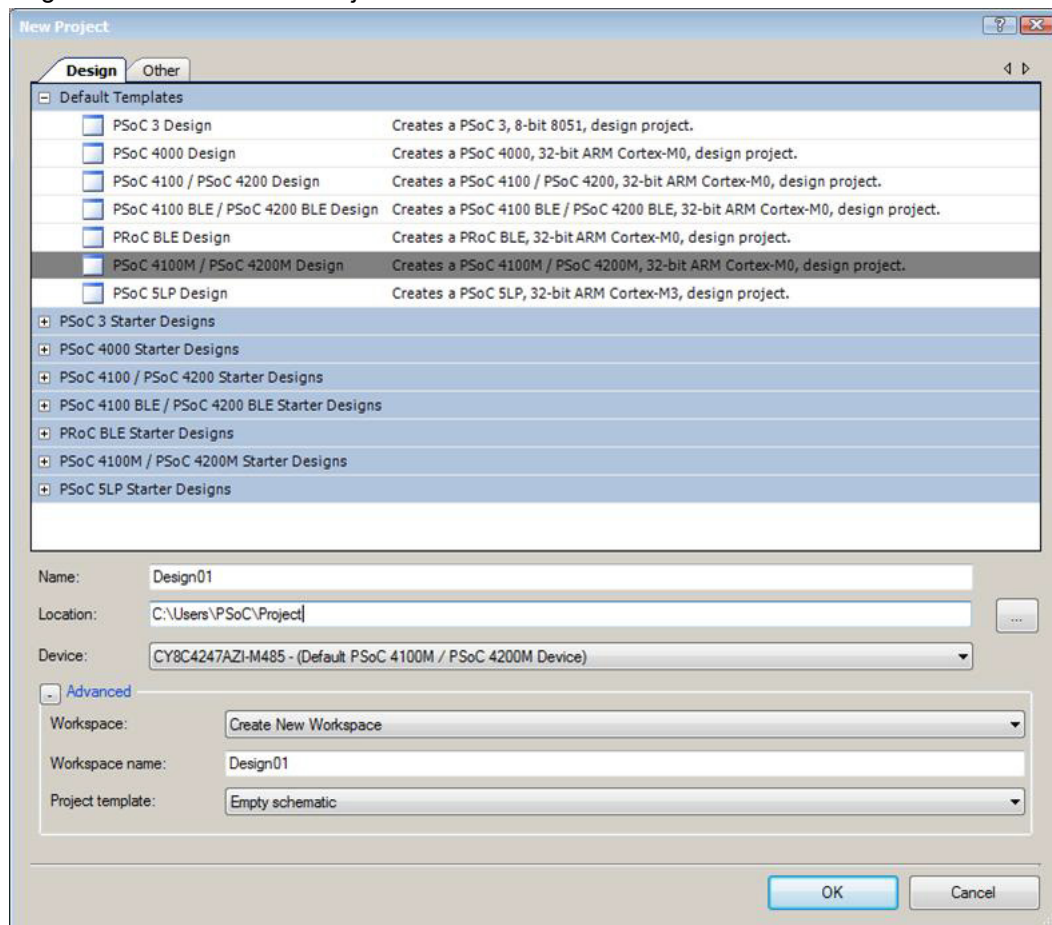

2. Drag and drop an EZI2C Slave (SCB mode) Component from the Component Catalog (see [Figure 6-2](#)) to the TopDesign. The Component Catalog is located along the right side of the PSoC Creator window by default. To configure the EZI2C Slave Component, double-click or right-click the **EZI2C Slave Component** and select **Configure**, as shown in [Figure 6-3](#).

Figure 6-2. EZI2C Slave Component in Component Catalog

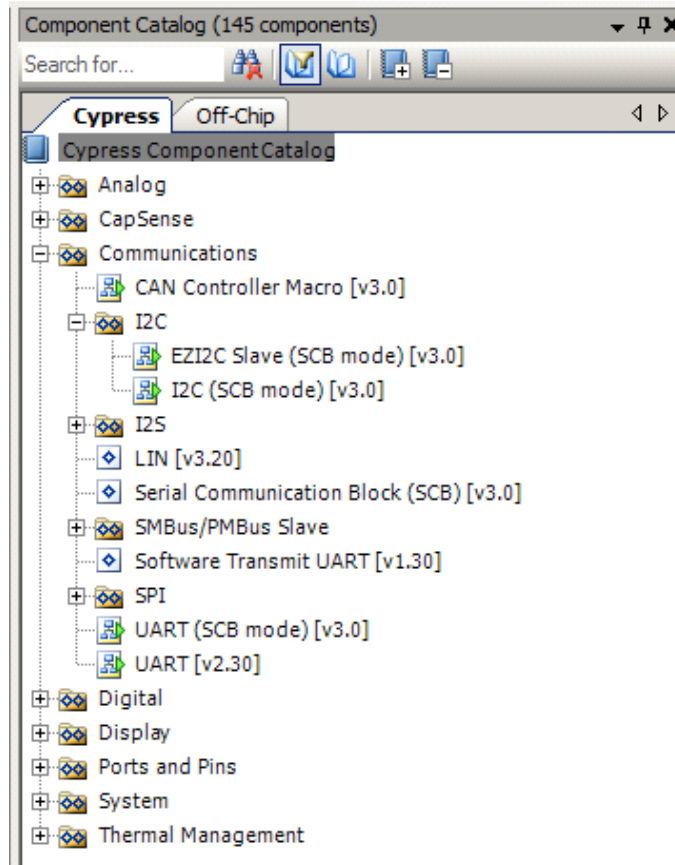
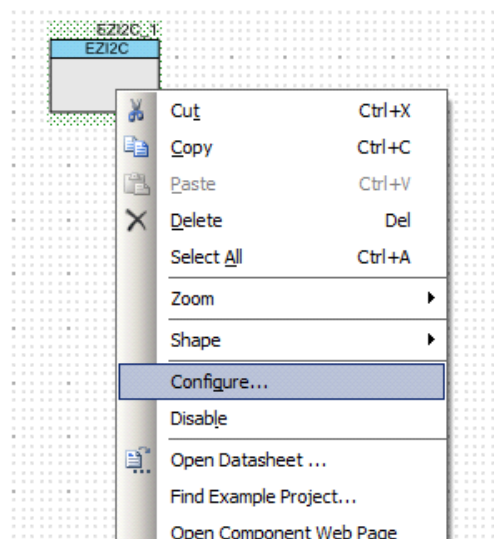

Figure 6-3. Open EZI2C Slave Configuration Window



3. Configure the EZI2C Slave Component as shown in [Figure 6-4](#) and [Figure 6-5](#), and then click **OK**.

Figure 6-4. Configuration Tab

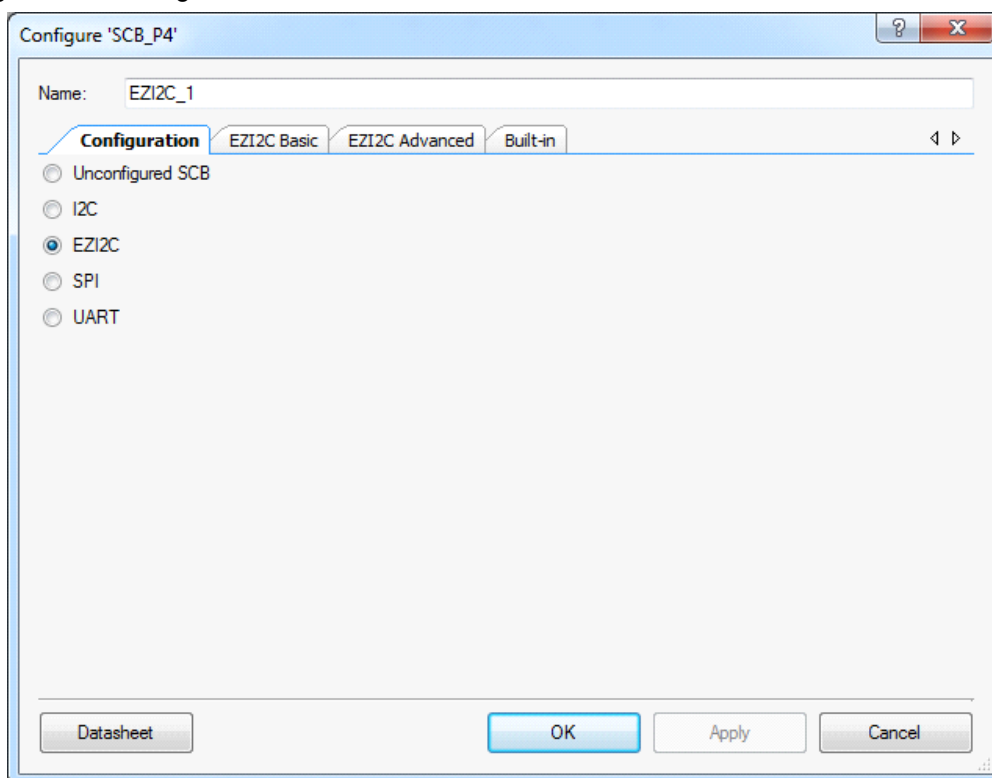
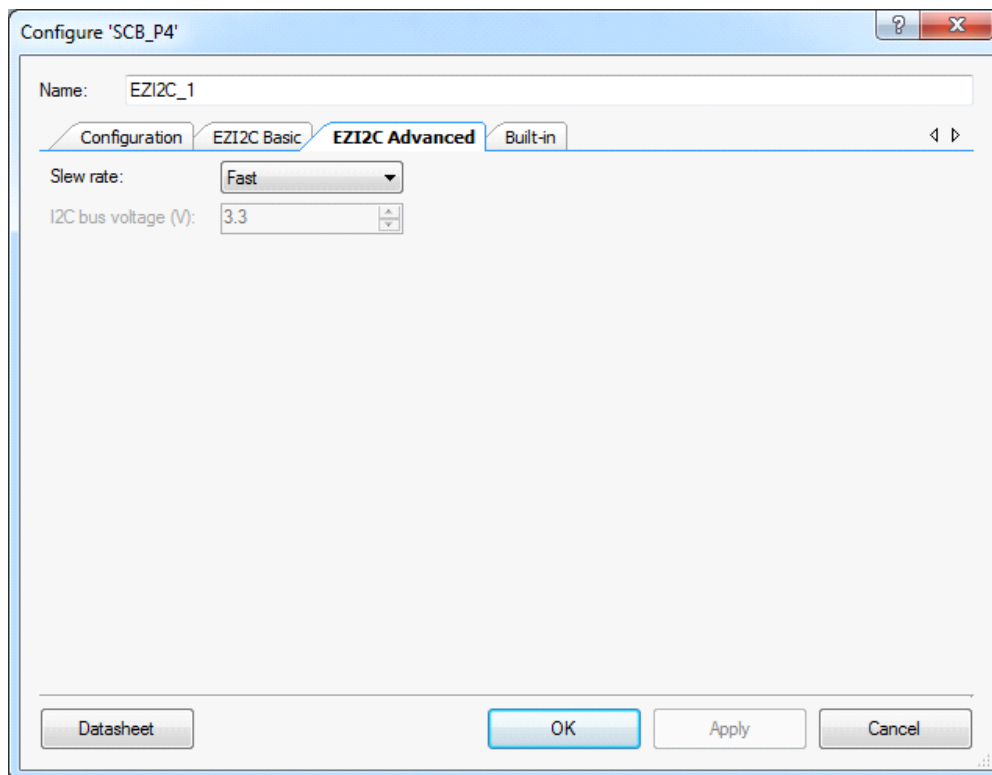
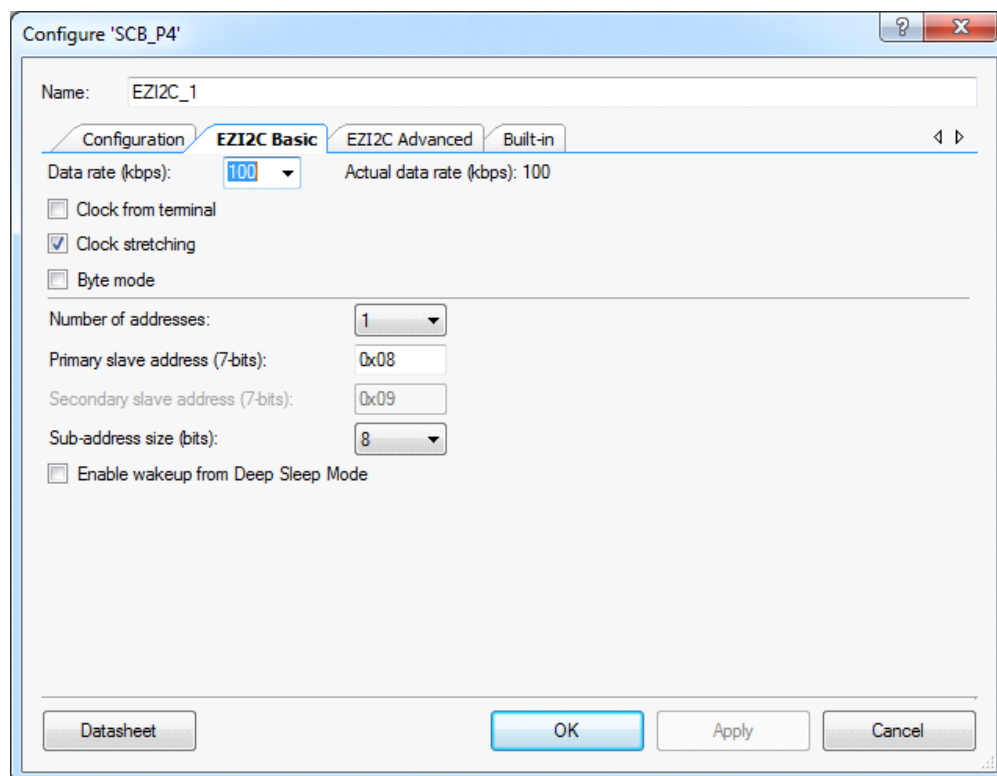

Figure 6-5. EZI2C Slave Basic and Advanced Tabs\



- Select pin P4[0] for the I2C SCL and pin P4[1] for the I2C SDA in the **Pins** tab of `<Project_Name>.cydwr`, as shown in [Figure 6-6](#). The `<Project_Name>.cydwr` file is available in the Workspace Explorer window, which is located along the left side of the PSoC Creator window by default. Double-click on the file to open it. Note that these are the pins for the USB-I2C interface on the PSoC 4 M-Series Pioneer kit. If you are using a different kit, refer to the respective Kit Guide for the appropriate pins.

Figure 6-6. Pin Selection

Alias	Name /	Port	Pin	Lock
\EZI2C_1:scl\		P4[0] SCB0:uart_rx, CAN0:can_rx, SCB0:i2c scl, SCB0:spi mosi	27	<input checked="" type="checkbox"/>
\EZI2C_1:sda\		P4[1] SCB0:uart_tx, CAN0:can_tx, SCB0:i2c sda, SCB0:spi miso	28	<input checked="" type="checkbox"/>

- Place the following code in the `main.c` file. The code will enable the PSoC 4200M device with the BCP application using the EZI2C Slave interface.

**Note:** The `main.c` file can be found on the Workspace Explorer window, which is located along the left side of the PSoC Creator window by default. Double-click on the file to open it.

```
#include <project.h>

#define BUF_SIZE          0x0A
#define READ_WRITE_SIZE  0x05

int main()
{
    /* I2C Read/Write Buffer. */
    uint8 i2cBuffer[BUF_SIZE];

    CyGlobalIntEnable;

    EZI2C_1_Start();

    /* This API sets the buffer and address boundary to which the external
     * master can communicate. In this example, external master can read
     * from and write to the first 5 bytes of the i2cBuffer and read bytes
     * from all the 10 bytes of the i2cBuffer array. */
    EZI2C_1_EzI2CSetBuffer1(BUF_SIZE, READ_WRITE_SIZE, i2cBuffer);

    for(;;)
    {

    }
}
```

- Build the project by choosing **Build > Build Project** or pressing **[Shift] [F6]**. After the project is built without errors and warnings, program (**[Ctrl] [F5]**) this project onto the PSoC 4200M using KitProg.
- Open the BCP from **Start > All Programs > Cypress > Bridge Control Panel <version> > Bridge Control Panel <version>**.

8. Select **KitProg/<serial number>** under **Connected I2C/SPI/RX8 Ports**, as shown in [Figure 6-7](#).

Figure 6-7. Connecting to KitProg in BCP

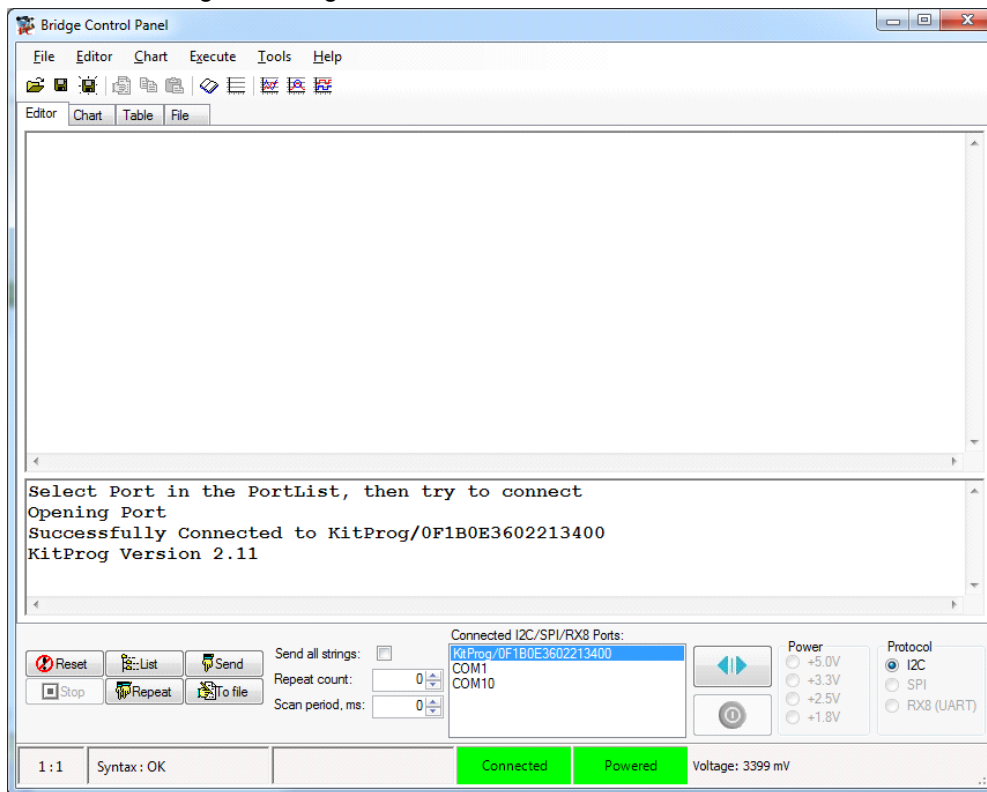

9. Open **Protocol Configuration** from the Tools menu and select the appropriate **I2C Speed**, as shown in [Figure 6-8](#). Ensure that the I2C speed is the same as the one configured in the EZI2C Slave Component. Click **OK** to close the window.

Figure 6-8. Opening Protocol Configuration Window in BCP

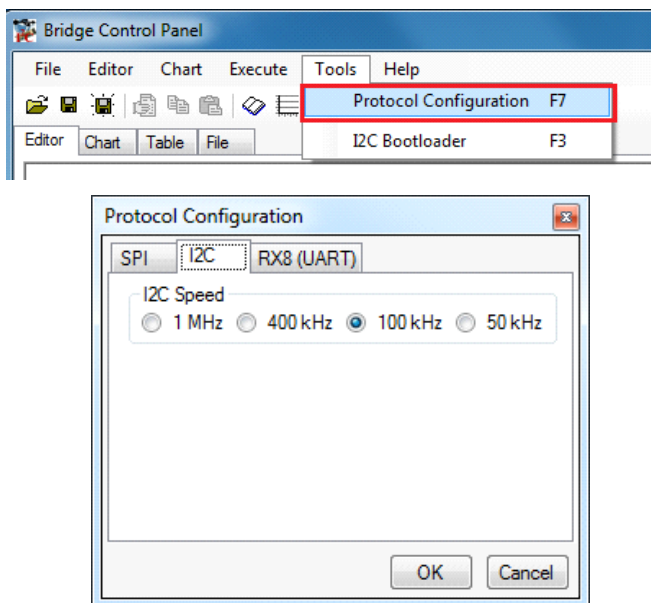



10. From the BCP, transfer 5 bytes of data to the I2C device with slave address 0x08. The EZI2C Slave requires an additional parameter to be sent from the BCP to set the offset address from/to where the data bytes are read/written. Type the command shown in [Figure 6-9](#) and press **[Enter]** or click the **Send** button in the BCP. The log shows whether the transaction was successful. A “+” after a byte indicates that the transaction was successful, and a “-” indicates that the transaction was a failure.

Figure 6-9. Enter Commands in BCP

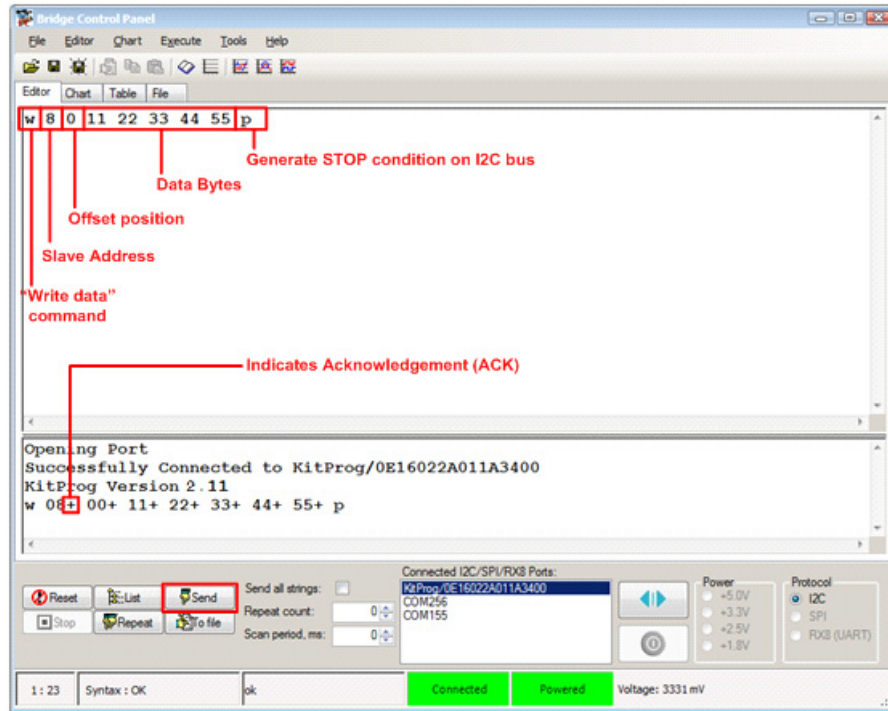

11. From the BCP, read 5 bytes of data from the I2C slave device with slave address 0x08. The log shows if the transaction was successful, as shown in [Figure 6-10](#).

Figure 6-10. Read Data Bytes from BCP

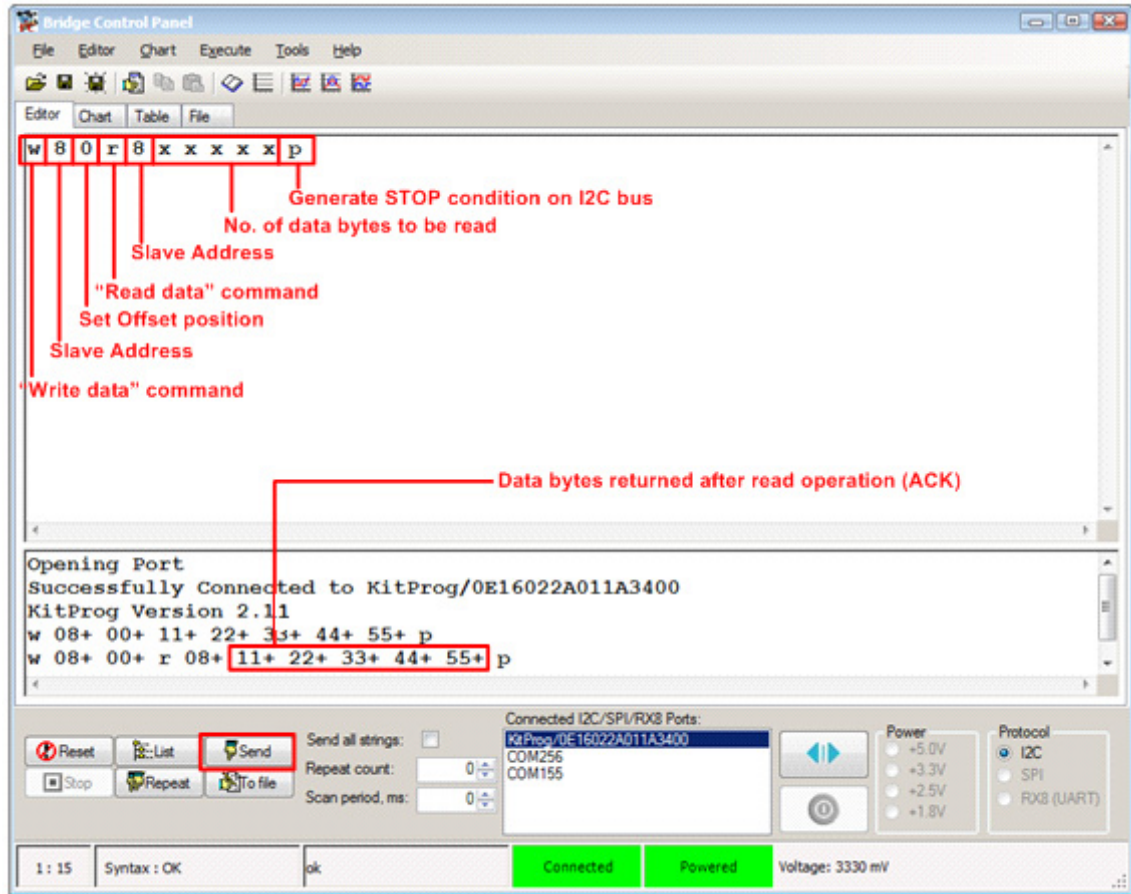

**Note:** You can add additional lines of commands by pressing **[Ctrl] [Enter]**. To execute any line, click on that line and press **[Enter]** or click the **Send** button.

Refer to **Help > Help Contents** in the BCP or press **[F1]** for more information on the I2C commands.

# 7. Developing Applications for PSoC 5LP



The KitProg is implemented using a PSoC 5LP device. You can also use the PSoC 5LP as a mixed-signal system-on-chip device to build your own custom projects. For example, the PSoC 5LP on the kit can be reprogrammed to act as a function generator for the kit. Refer to the application note [AN69133 - PSoC<sup>®</sup> 3 / PSoC 5LP Easy Waveform Generation with the WaveDAC8 Component](#) for details on how to create waveforms using a PSoC 5LP device.

Two types of projects can be created for a PSoC 5LP that runs KitProg: **Bootloadable** and **Normal**. Bootloadable projects can be programmed into the PSoC 5LP using the USB connection from a PC without any specialized hardware. To program Normal projects, you will require a [MiniProg3](#). You also need to populate the PSoC 5LP programming header on the development kit. For the PSoC 4 M-Series Pioneer Kit, this header is marked **J5**. See the respective kit guide for more information on the PSoC 5LP programming header. Jump to the section [Building a Normal Project for PSoC 5LP chapter on page 42](#), if you want to create a normal project for PSoC 5LP.

To learn more about the bootloading concept, refer to the application note [AN73854 - PSoC<sup>®</sup> 3, PSoC 4, and PSoC 5LP Introduction to Bootloaders](#).

**Note:** The CY3280-MBR3 CapSense Evaluation Kit does not have a provision to populate the programming header for PSoC 5LP.

The following sections provide step by step directions for building a Bootloadable and a Normal project for PSoC 5LP.

## 7.1 Building a Bootloadable Project for PSoC 5LP

All bootloadable applications developed for the PSoC 5LP should be based on the bootloader *.hex* file, which is programmed onto the kit. Therefore, you will need to provide the location of the bootloader *.hex* file inside the bootloadable project.

The bootloader *.hex* file is included in the kit installer directory in the following path, as shown in [Figure 7-1](#):

```
<Install_Directory>\<Kit_Name>\<version>\Firmware\Programmer\KitProg_Boot loader
```

Figure 7-1. KitProg Bootloader Hex File Location

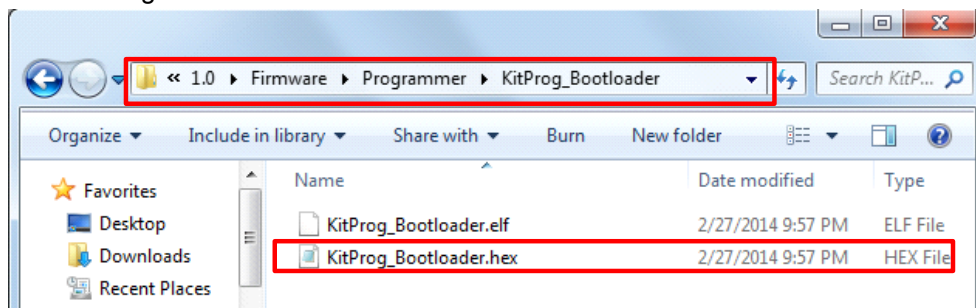

To build a bootloadable application for the PSoC 5LP, follow this procedure:

1. In PSoC Creator, choose **New > Project** and click the **PSoC 5LP Design**; select **Launch Device Selector** from the drop-down list for **Device** to bring up the **Select PSoC 5LP Device** window and select **CY8C5868LTI-LP039**, as shown in [Figure 7-3](#). Click **OK**.

**Note:** If you have not set the **Application Type** as **Bootloadable** in the New Project window under the Advanced section (in PSoC Creator 3.1 or earlier), you can change it in the existing project by selecting **Project > Build Settings** and click the **<Project Name> > Application Type > Bootloadable**. Beginning with PSoC Creator 3.2, the **Application Type** option is removed from the New Project window and the Build Settings menu. PSoC Creator 3.2 automatically recognizes the application type from the TopDesign schematic.

Figure 7-2. Open New Project in PSoC Creator

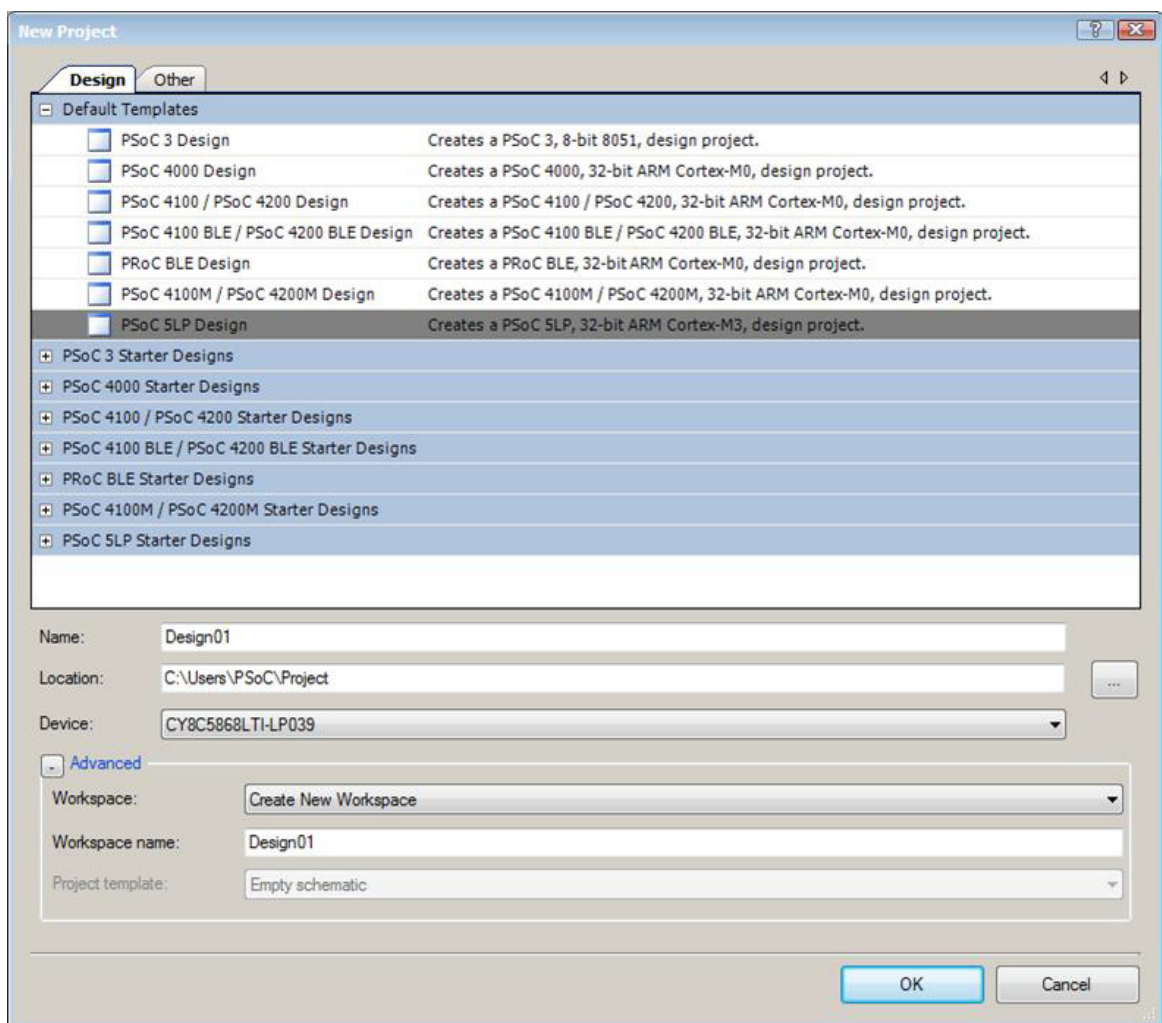
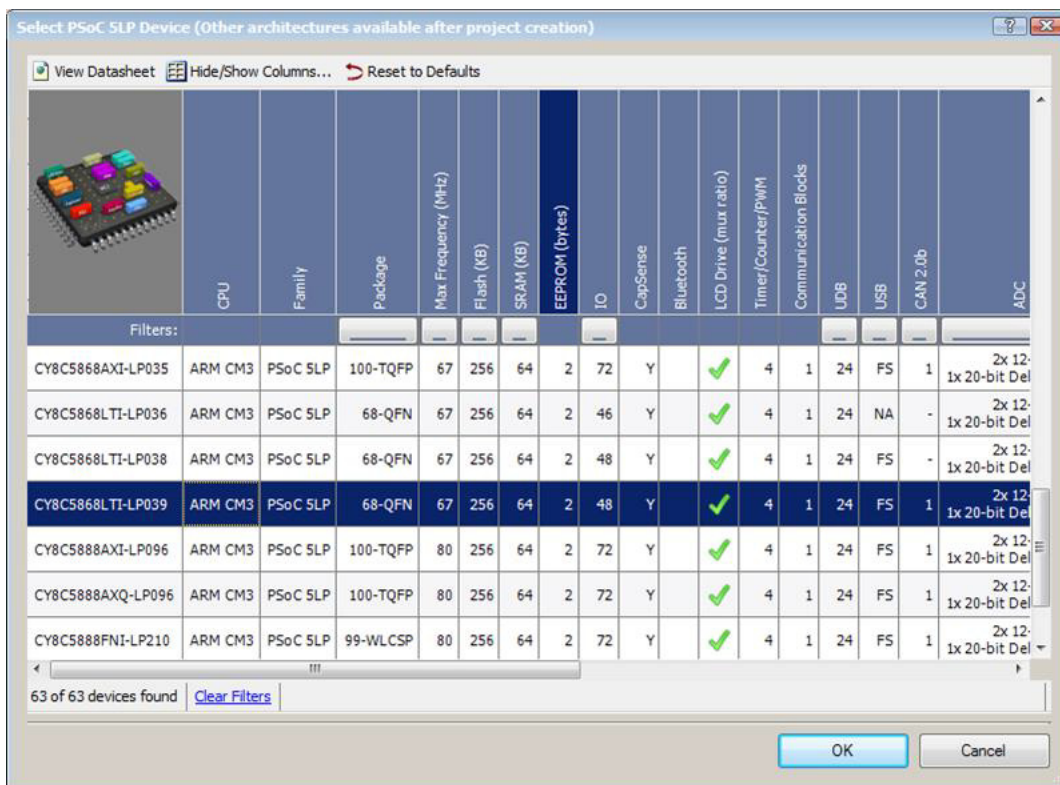
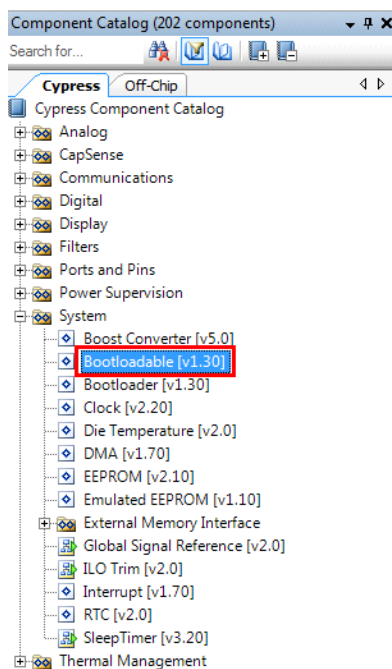

Figure 7-3. Select Device in PSoC Creator



- Navigate to the Schematic view and drag and drop a Bootloadable Component (see Figure 7-4) on the TopDesign.

Figure 7-4. Bootloadable Component in Component Catalog



- Set the dependency of the Bootloadable Component by selecting the **Dependencies** tab in the configuration window and clicking the **Browse** button, as shown in Figure 7-5. Select the *KitProg\_Bootloader.hex* (see Figure 7-6) and click **Open**.

**Note:** The *KitProg\_Bootloader.elf* is selected automatically if it is also available with the same name in the same path. Ensure that both *.hex* and *.elf* file exist in the same folder by the same name.

Figure 7-5. Configuration Window of Bootloadable Component

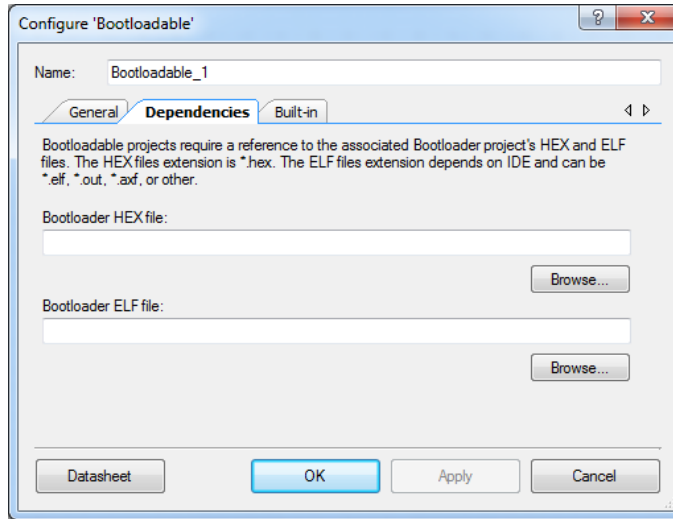
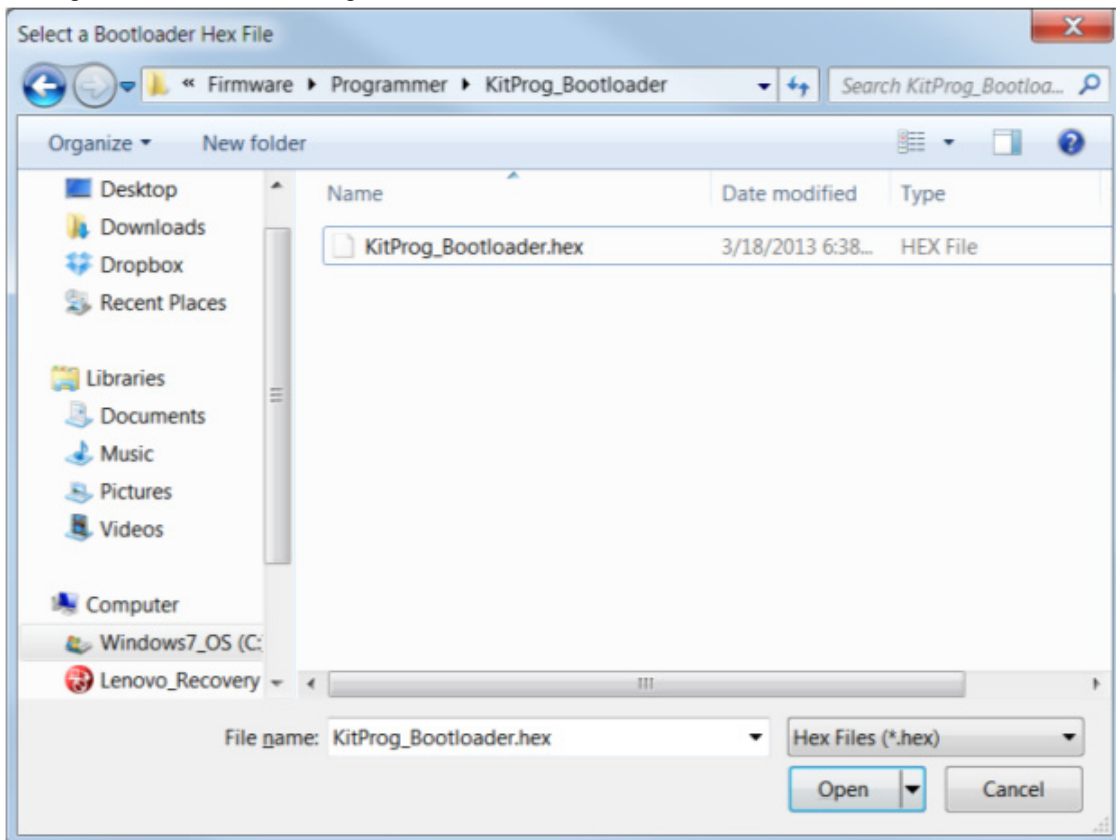
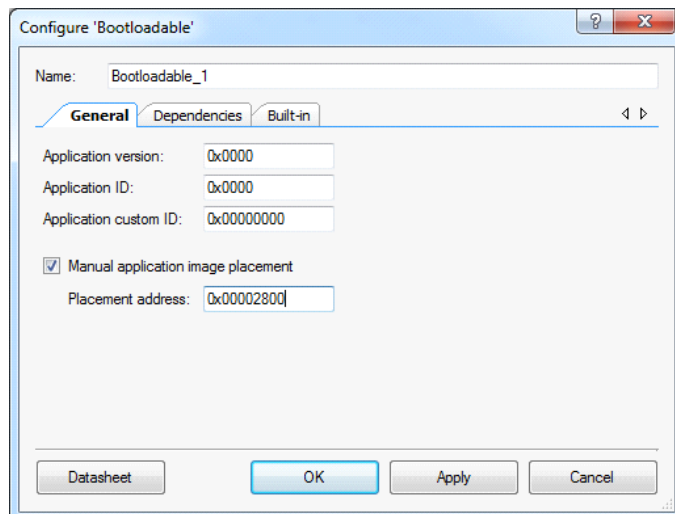

Figure 7-6. Select KitProg Bootloader Hex File



- In the **General** tab, check the **Manual application image placement** checkbox and set the **Placement address** as '0x00002800', as shown in Figure 7-7.

Figure 7-7. Bootloadable Component-General Tab



- Develop your custom project.
- Ensure that the `<project name>.cydwr` **System** settings of the Bootloadable project and the KitProg\_Bootloader project are the same. Figure 7-8 shows the `KitProg_Bootloader.cydwr` **System** settings.

Figure 7-8. KitProg Bootloader System Settings

Option	Value
Configuration	
Device Configuration Mode	Compressed
Enable Error Correcting Code (ECC)	<input type="checkbox"/>
Store Configuration Data in ECC Memory	<input type="checkbox"/>
Instruction Cache Enabled	<input checked="" type="checkbox"/>
Enable Fast.I/MO During Startup	<input checked="" type="checkbox"/>
Unused Bonded IO	Allow but warn
Heap Size (bytes)	0x1000
Stack Size (bytes)	0x4000
Include CMSIS Core Peripheral Library Files	<input checked="" type="checkbox"/>
Programming\Debugging	
Debug Select	GPIO
Enable Device Protection	<input type="checkbox"/>
Embedded Trace (ETM)	<input type="checkbox"/>
Use Optional XRES	<input type="checkbox"/>
Operating Conditions	
Variable VDDA	<input type="checkbox"/>
VDDA (V)	5
VDDD (V)	5
VDDIO0 (V)	5
VDDIO1 (V)	5
VDDIO2 (V)	5
VDDIO3 (V)	5
Temperature Range	-40C - 85/125C
Pins Analog Clocks Interrupts DMA <b>System</b> Directives Flash Security EEPROM	

7. Build the project in PSoC Creator by choosing **Build > Build Project** or pressing **[Shift] [F6]**.
8. To program the project onto the PSoC 5LP device, open the Bootloader Host tool, which is available in PSoC Creator. Choose **Tools > Bootloader Host**, as shown in [Figure 7-9](#).

Figure 7-9. Open Bootloader Host Tool in PSoC Creator

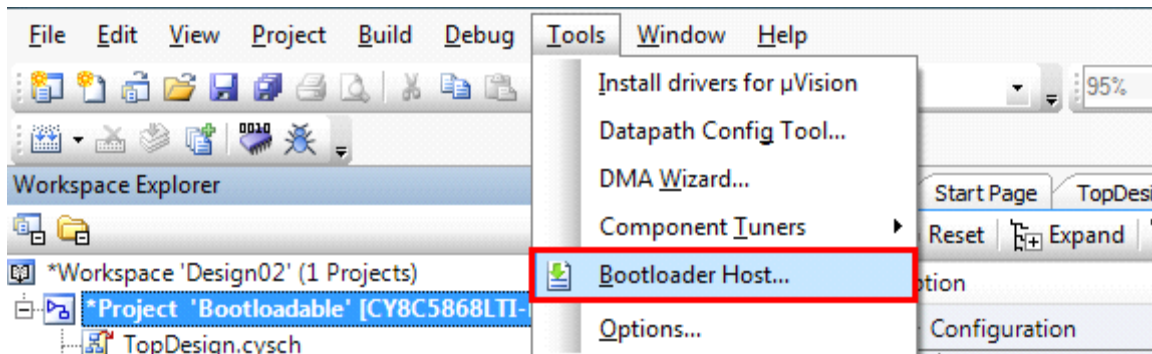

9. Keep the reset switch (**SW1**) pressed and connect the kit to the computer. If the switch is pressed for more than 100 ms, the PSoC 5LP enters the bootloader.
10. In the Bootloader Host tool, click **Filters** and add a filter to identify the USB device. Ensure that the check box for **Show USB Devices** is enabled. Set VID as **0x04B4**, PID as **0xF13B**, and click **OK**, as shown in [Figure 7-10](#).

Figure 7-10. Port Filters Tab in Bootloader Host Tool

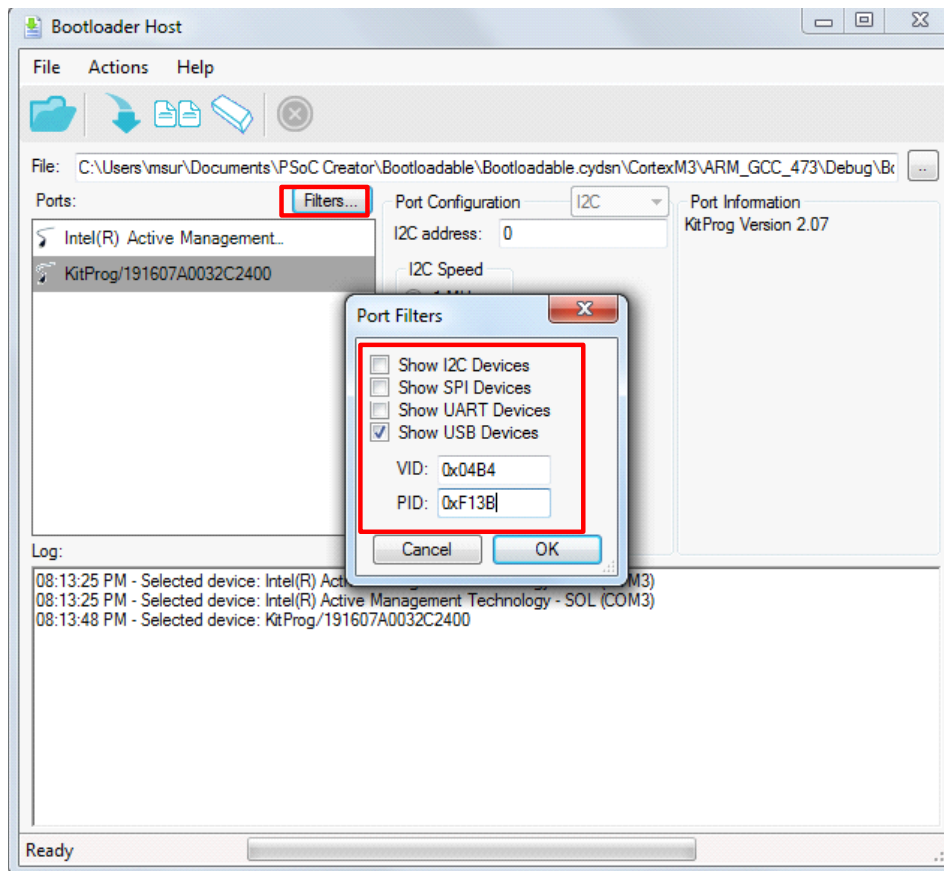



11. In the Bootloader Host tool, click the **Open File** button (Figure 7-11) to browse to the location of the bootloadable file (\*.cyacd), as shown in Figure 7-12. This file is present in the project directory.

Figure 7-11. Open Bootloadable File in Bootloader Host Tool

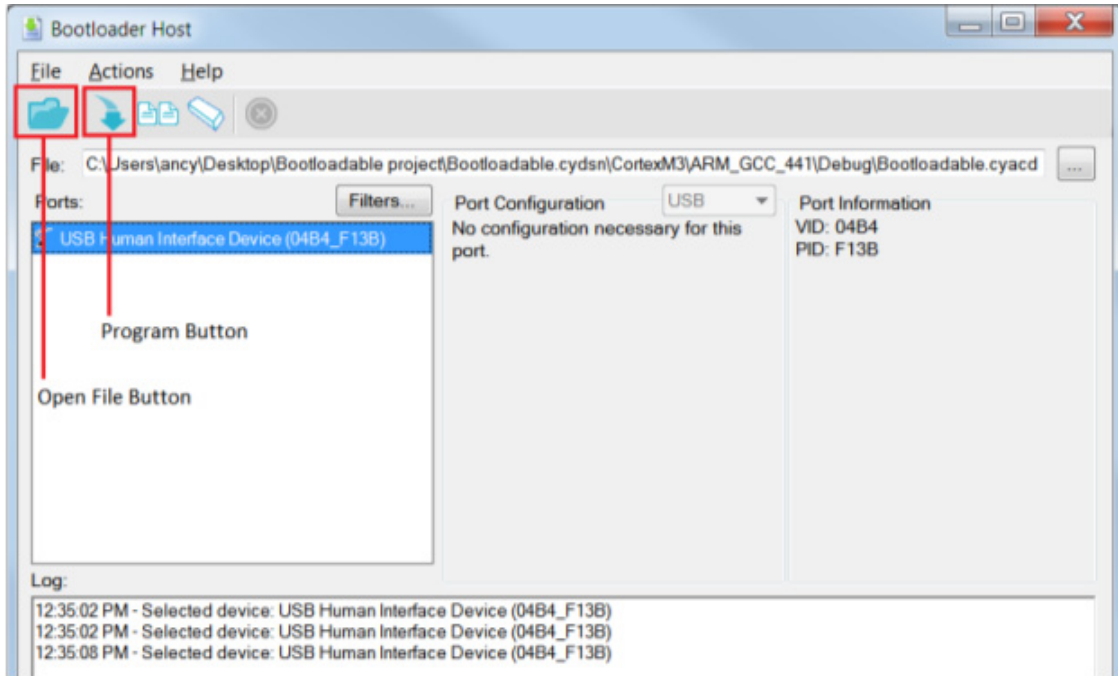
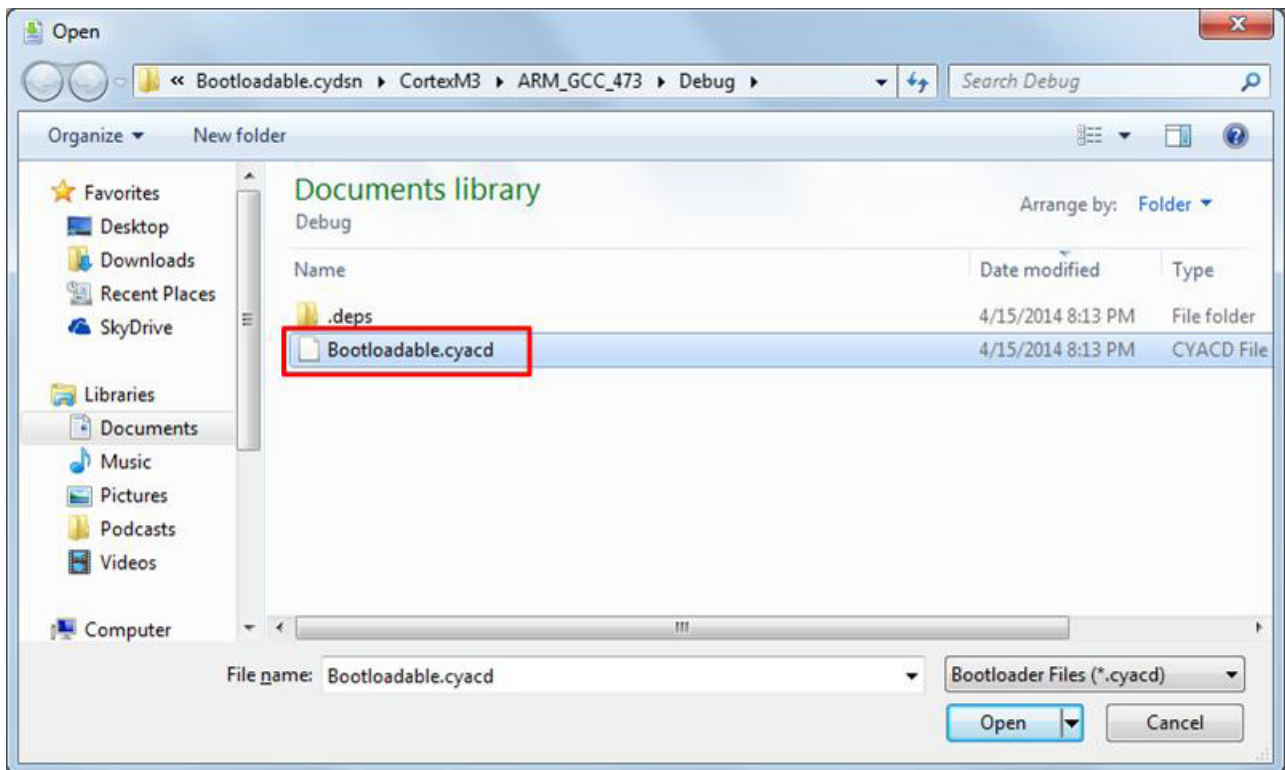

Figure 7-12. Select Bootloadable .cyacd File from Bootloader Host Tool



12. Select the **USB Human Interface Device** in the **Ports** list and click the **Program** button (Figure 7-11) in the Bootloader Host tool to program the device.
13. If the bootload is successful, the log displays “Programming Finished Successfully”; otherwise, it displays “Failed” and a reason for the failure.

**Notes:**

- The PSoC 5LP pins are connected to the PSoC 5LP GPIO header. These pins are selected to support high-performance analog and digital projects. See [A.1 Pin Assignment Tables](#) for pin information.
- Take care when allocating the PSoC 5LP pins for custom applications. For example, P3[2]-P3[3] are dedicated for programming the PSoC 4200M in CY8CKIT-044. Refer to the respective kit schematics before allocating the pins.
- When a custom bootloadable project is programmed onto the PSoC 5LP, the initial capability of the PSoC 5LP to act as a programmer, USB-UART bridge, or USB-I2C bridge is not available. To recover this functionality, bootload the KitProg file back into the PSoC 5LP. The file is available in the kit installation directory at:  

```
<Install_Directory>\<Kit_Name>\<version>\Firmware\Programmer\KitProg\KitProg.cyacd
```
- The status LED does not function unless it is used by the custom project.

For additional information on bootloaders, refer to the [AN73503 - USB HID Bootloader for PSoC 3 and PSoC 5LP](#).

## 7.2 Building a Normal Project for PSoC 5LP

A normal project is a completely new project created for the PSoC 5LP device on the PSoC 4 M-Series Pioneer board. Here the entire flash of the PSoC 5LP is programmed, overwriting all boot-loader and programming code. To recover the programmer, USB-UART bridge or USB-I2C bridge functionality, reprogram the PSoC 5LP device with the factory-set KitProg.hex file, which is shipped with the kit installer.

**Note:** You cannot program a normal PSoC 5LP project into the KitProg's PSoC 5LP device in prototyping kits such as CY8CKIT-059 and CY8CKIT-043. The PSoC 5LP device present in the KitProg of the prototyping kits supports programming through bootloading only.

The *KitProg.hex* file is available at the following location:

```
<Install_Directory>\<Name_of_the_Kit>\<version>\Firmware\Programmer\KitProg\KitProg.hex
```

This advanced functionality requires a MiniProg3 programmer, which is not included with this kit. The MiniProg3 can be purchased from [www.cypress.com/go/CY8CKIT-002](http://www.cypress.com/go/CY8CKIT-002). In addition, the 10-pin PSoC 5LP programming header (PSoC 5LP PROG) on the kit needs to be populated (refer to the kit's Bill of Materials for ordering the part) to connect the MiniProg3 for programming and debugging the PSoC 5LP device.

To build a normal project for the PSoC 5LP, follow these steps:

1. In PSoC Creator, choose **New > Project** and click the **PSoC 5LP Design**; select **Device** as **CY8C5868LTI-LP039** (see [Figure 7-13](#)), and then click **OK**.

Figure 7-13. Create New Project in PSoC Creator

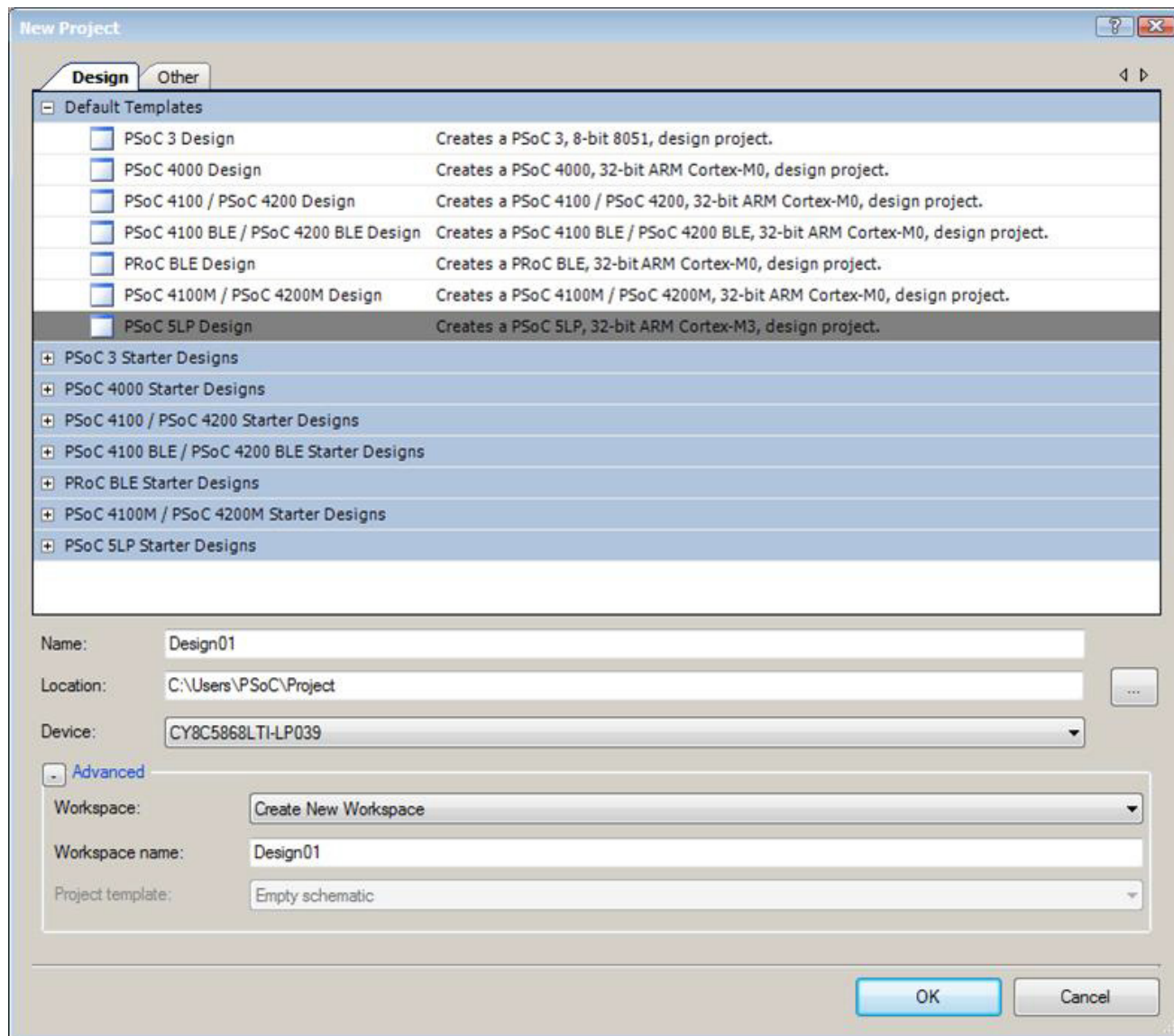

2. Develop your custom project.
3. Build the project in PSoC Creator by choosing **Build > Build Project** or pressing **[Shift] [F6]**.
4. Connect the 10-pin connector of MiniProg3 to the onboard PSoC 5LP PROG header.
5. To program the PSoC 5LP with PSoC Creator, choose **Debug > Program** or press **[Ctrl] [F5]**. If the **Select Debug Target** window appears and shows MiniProg3 and the selected device in the project under it (CY8C5868LTI-LP039), click on the device and click **Connect** to program.

**Notes:**

- The 10-pin PSoC 5LP programming header is not populated.
- The PSoC 5LP pins are brought to the PSoC 5LP GPIO header. These pins are selected to support high-performance analog and digital projects. See [A.1 Pin Assignment Tables](#) for pin information.
- Take care when allocating the PSoC 5LP pins for custom applications. For example, P3[2]-P3[3] are dedicated for programming the PSoC 4200M in CY8CKIT-044. Refer to the respective kit schematics before allocating the pins.
- When a normal project is programmed onto the PSoC 5LP, the initial capability of the PSoC 5LP to act as a programmer, USB-UART bridge, or USB-I2C bridge is not available.
- The status LED does not function unless it is used by the custom project.

# 8. Troubleshooting the KitProg



This section explains the methods to troubleshoot the KitProg and recover the KitProg firmware if you modified it.

## 8.1 KitProg Status LED Indication

The KitProg Status LED on the development kit indicates the status of the KitProg operation using different blink rates. [Table 8-1](#) shows the KitProg LED indication and the corresponding status of the KitProg.

Table 8-1. Meaning of KitProg LED Indications

User Indication	Scenario	Action Required by User
LED blinks fast: Frequency = 4.00 Hz	LED starts blinking at power up, if bootloadable file is corrupt.	Bootload the <i>KitProg.cyacd</i> file: In PSoC Programmer, connect to the kit, go to the <b>Utilities</b> tab, and press the <b>Upgrade Firmware</b> button.
LED blinks slow: Frequency = 0.67 Hz	Entered Bootloader mode by holding the Reset button during kit power-up.	Release the Reset button and re-plug the kit if you entered this mode by mistake. If the mode entry was intentional, bootload the new <i>.cyacd</i> file using the Bootloader Host tool available in PSoC Creator.
LED blinks very fast: Frequency = 15.0 Hz	SWD or I2C operation is in progress. The Kit's COM port connect / disconnect event (only one blink).	In PSoC Programmer, watch the log window for status messages for SWD operations. In the BCP, the LED blinks on I2C command requests. In BCP or any other serial port terminal program, distinguish the kit's COM port number by the blinking LED when the port is connected or disconnected.
LED is ON	USB enumeration successful. Kit is in the idle state waiting for commands.	PSoC Creator, PSoC Programmer, BCP, and any serial port terminal program can use the kit functions.
LED is OFF	Power LED is ON	This means that the USB enumeration was unsuccessful. This may happen if the kit is not powered from the USB host. Verify the USB cable and check if PSoC Programmer is installed on the PC.

**Note:** The Bridge Control Panel software cannot connect to the KitProg, if the KitProg firmware version is outdated. Refer to [Updating the KitProg Firmware](#) on how to update the KitProg firmware.

**Note:** The programming/debugging function and USB-I2C bridge function of the KitProg are mutually exclusive functions and cannot be used together. As a result, in order to use one function, the other function should be disconnected. For instance, in order to program the device while using USB-I2C bridge in BCP, either close BCP or disconnect the USB-I2C bridge in BCP. The USB-UART bridge function of the KitProg, however, can run in parallel to both programming/debugging and USB-I2C bridge functions.

## 8.2 PSoC 5LP Factory Program Restore Instructions

### 8.2.1 PSoC 5LP is Programmed with a Bootloadable Application

Reprogramming or bootloading the PSoC 5LP device with a new flash image will overwrite the KitProg and forfeit the ability to use the PSoC 5LP device as a programmer/debugger for the kit. If the PSoC 5LP is programmed with a bootloadable application, restore the KitProg by using one of the following two methods:

- [Restore PSoC 5LP Factory Program Using PSoC Programmer](#)
- [Restore PSoC 5LP Factory Program Using Bootloader Host Tool](#)

**Note:** This method cannot be used to recover the KitProg if the PSoC 5LP was reprogrammed using a MiniProg3. Jump to section [Restore PSoC 5LP using MiniProg3](#) if you want to recover the KitProg functionality using a MiniProg3.

#### 8.2.1.1 Restore PSoC 5LP Factory Program Using PSoC Programmer

1. Launch PSoC Programmer from **Start > Cypress > PSoC Programmer <version> > PSoC Programmer <version>**.
2. Configure the PSoC 4 M-Series Pioneer Kit in bootloader mode. To do this, while pressing the reset button (SW1 for pioneer kits and SW3 for prototyping kits), connect the PSoC 4 M-Series Pioneer Kit to the computer using the included USB cable (USB Standard-A to Mini-B). This puts the PSoC 5LP into bootloader mode, which is indicated by the blinking green status LED.
3. The following message appears in the PSoC Programmer **Results** window (see [Figure 8-1](#)):  
“KitProg Bootloader device is detected”.

Figure 8-1. PSoC Programmer Results Window

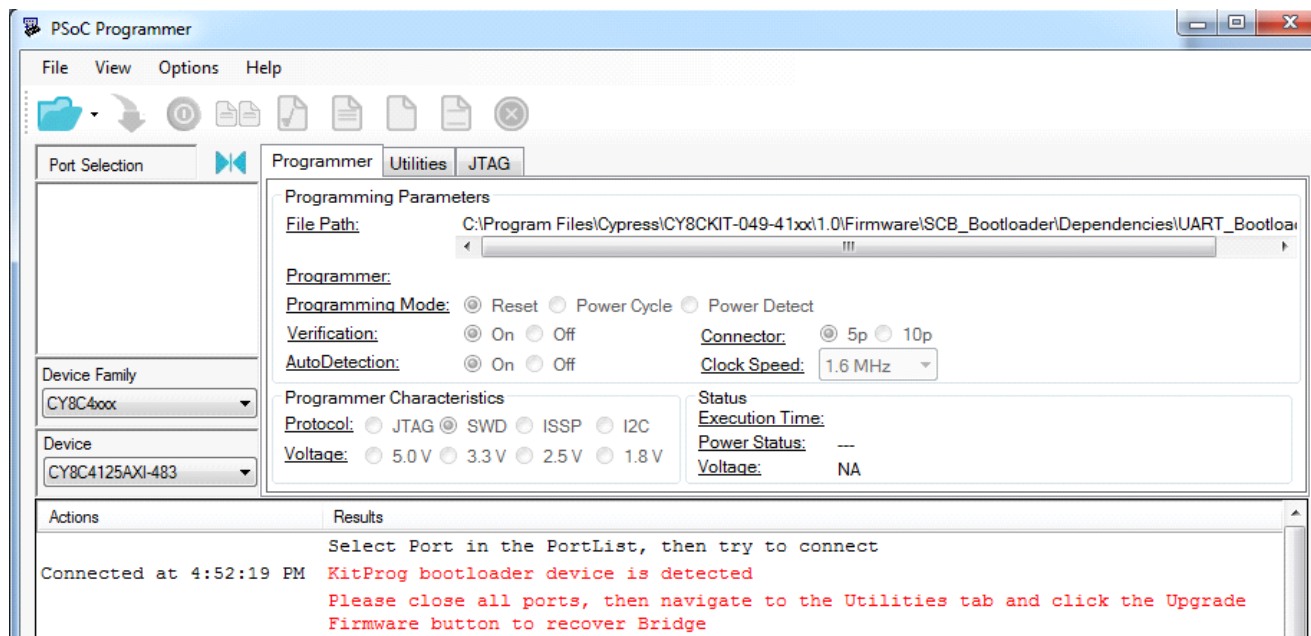

4. Switch to the **Utilities** tab in PSoC Programmer and click the **Upgrade Firmware** button, as shown in [Figure 8-2](#). Unplug all other PSoC programmers (such as MiniProg3 and DVKProg) from the PC prior to clicking the **Upgrade Firmware** button.

Figure 8-2. Upgrade Firmware

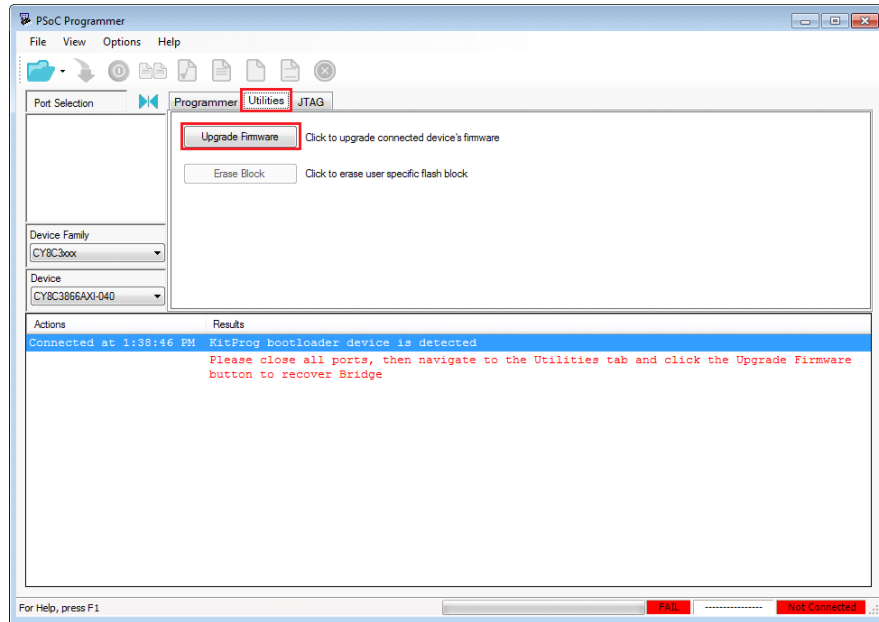

5. After programming is completed, the message “Firmware Update Finished at <time>” appears, and PASS message is indicated on the status bar, as shown in Figure 8-3.

Figure 8-3. Firmware Update Completed

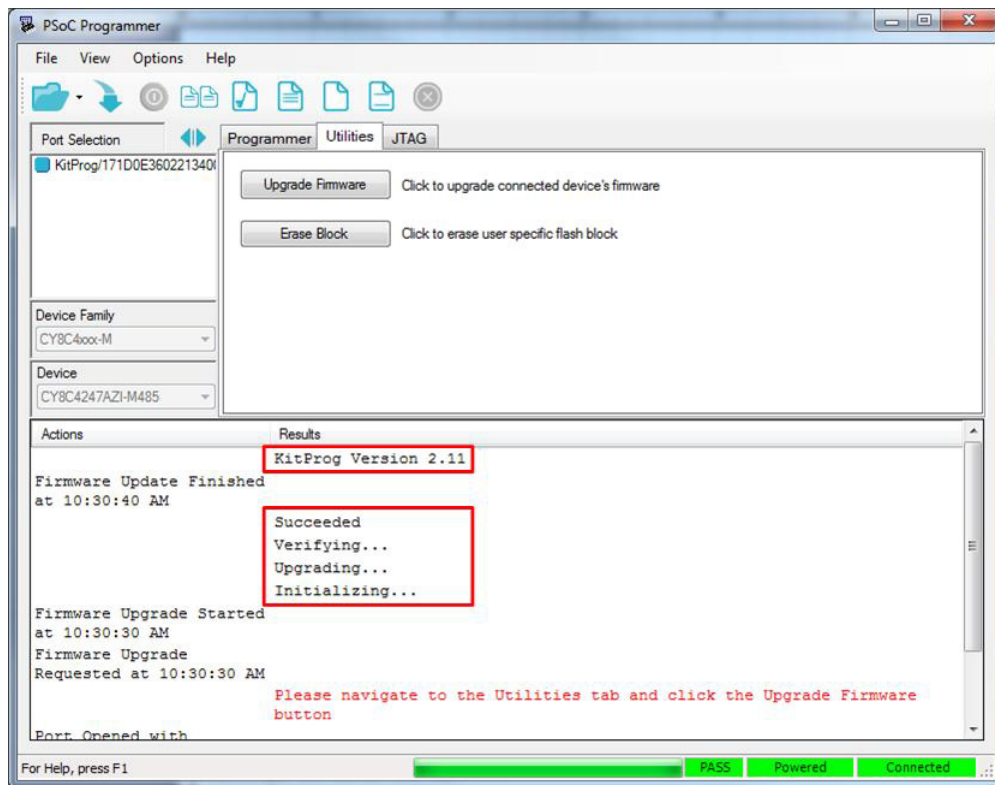

6. The factory program is now successfully restored on the PSoC 5LP. It can be used as the programmer/debugger for the PSoC 4200M device.

### 8.2.1.2 Restore PSoC 5LP Factory Program Using Bootloader Host Tool

1. Launch the Bootloader Host tool from **Start > Cypress > PSoC Creator <version> > Bootloader Host**.
2. Using the **File > Open** menu, load the *KitProg.cyacd* file, which is installed with the kit software, as shown in [Figure 8-4](#). The default location for this file is:

<Install\_Directory>\<Kit\_Name>\<version>\Firmware\Programmer\KitProg\KitProg.cyacd

Figure 8-4. Load KitProg .cyacd File

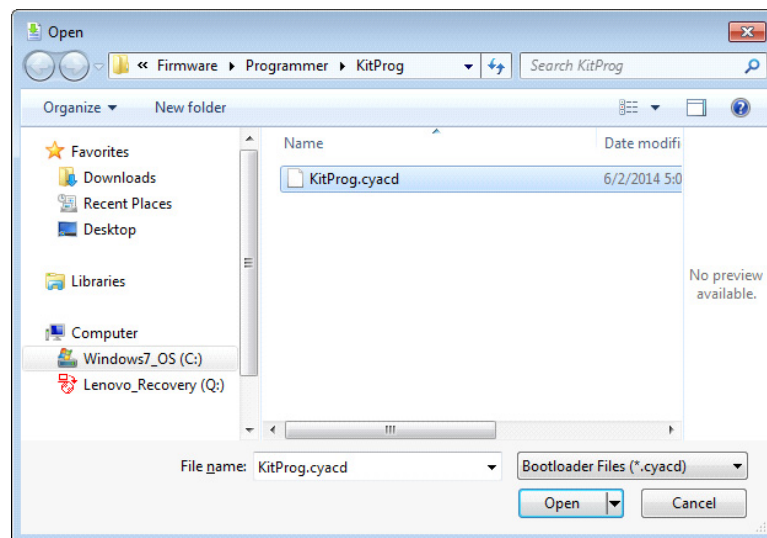
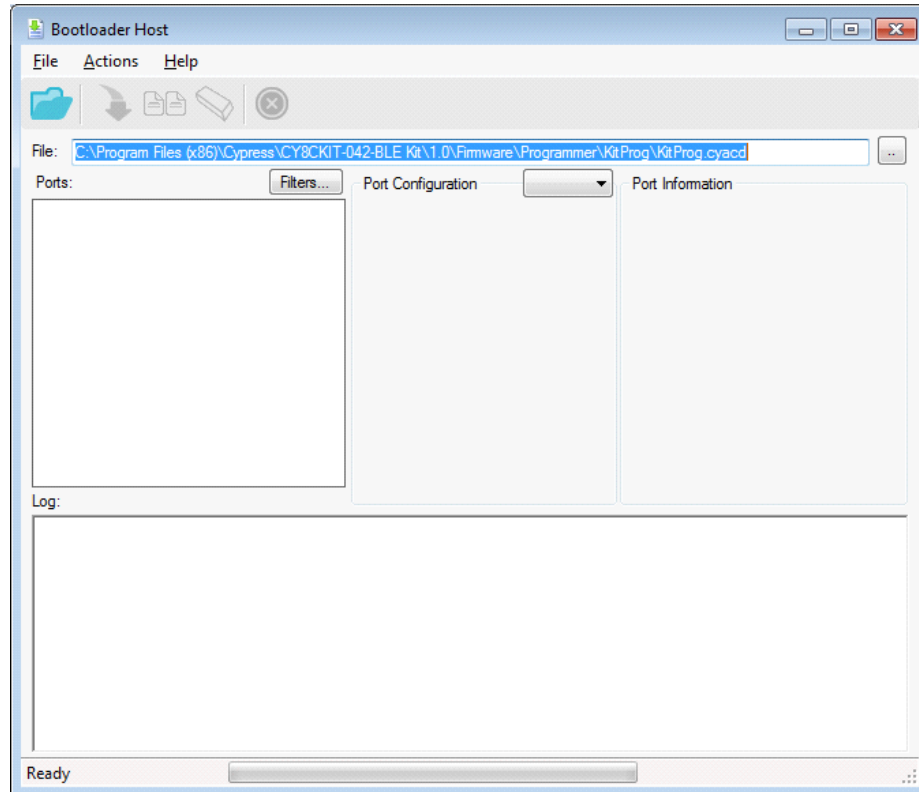



3. Configure the PSoC 4 M-Series Pioneer Kit in bootloader mode. To do this, while holding down the reset button (SW1 for pioneer kits and SW3 for prototyping kits), connect the PSoC 4 M-Series Pioneer Kit to the PC using the included USB cable (USB Standard-A to Mini-B). This puts the PSoC 5LP into bootloader mode, which is indicated by the blinking green status LED.
4. In the Bootloader Host tool, set the filters for the USB devices with **VID: 04B4** and **PID: F13B**. The **USB Human Interface Device** port appears in the **Ports** list. Click the port to select it, as shown in [Figure 8-5](#).

Figure 8-5. Select USB Human Interface Device

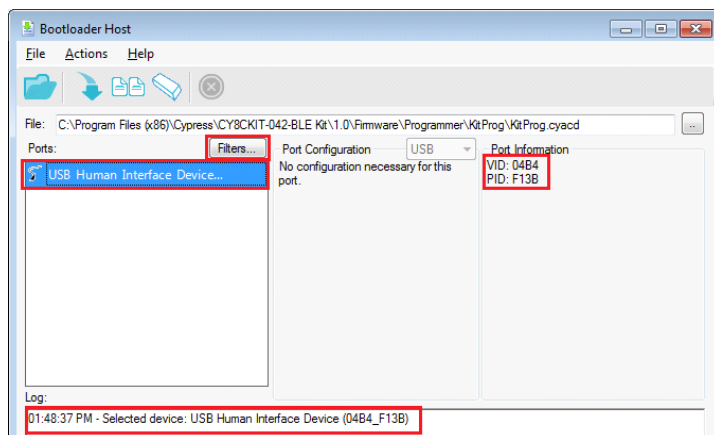

5. Click the **Program** button (or choose **Actions > Program**) to restore the factory program by bootloading it onto the PSoC 5LP.
6. After programming is completed, the message “Programming Finished Successfully” appears, as shown in [Figure 8-6](#).

Figure 8-6. Programming Finished Successfully

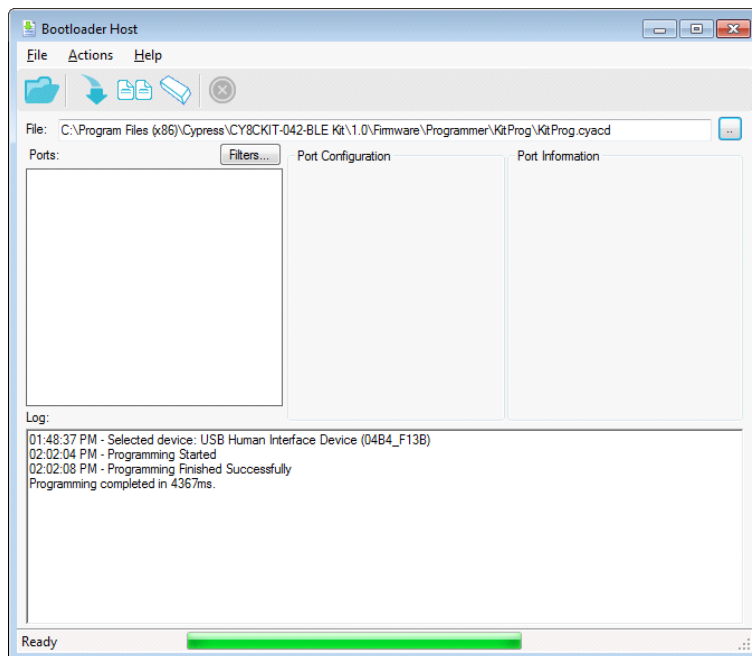

7. The factory KitProg program is now successfully restored on the PSoC 5LP.

## 8.2.2 Restore PSoC 5LP using MiniProg3

This section explains the method to reprogram the PSoC 5LP using a MiniProg3 to recover the KitProg functionality. This method must be used to recover the KitProg if the PSoC 5LP was completely reprogrammed.

**Note:** Programming of KitProg through MiniProg3 is not possible in prototyping kits (CY8CKIT-043 and CY8CKIT-059).

1. Launch PSoC Programmer from **Start > Cypress > PSoC Programmer <version> > PSoC Programmer <version>**.
2. Connect the MiniProg3 to the PC. Connect the 10-pin connector of MiniProg3 to the onboard PSoC 5LP programming header.

**Note:** This header is not populated by default. You will need to populate this header in order to connect a MiniProg3.

3. Select the **MiniProg3** from the **Port Selection** list in the PSoC Programmer on your PC.
4. Using the **File > Open** menu or using the **File Load** icon, load the *KitProg.hex* file, which is installed with the kit software, as shown in [Figure 8-7](#). The default location for this file is:

```
<Install
```

```
Path>\<Name_of_the_Kit>\<version>\Firmware\Programmer\KitProg\KitProg.hex
```

5. Select the **Power Cycle** option for Programming Mode, **10p** (10 pin) option for Connector, and the **SWD** option for Protocol.
6. Click the **Program** button or **File > Program** to program the PSoC 5LP device.
7. After programming is complete, the “Program Finished at <time>” message is displayed.

Figure 8-7. Select the *KitProg.hex* File to Program the PSoC 5LP

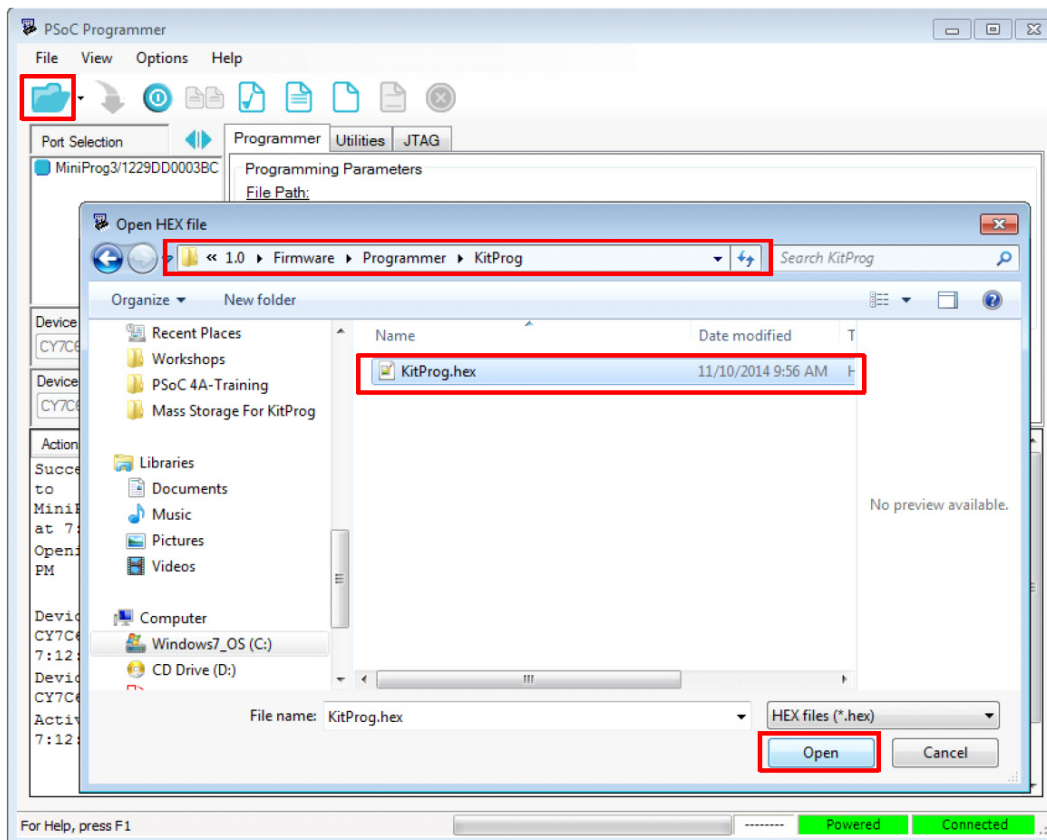

# A. Appendix



## A.1 Pin Assignment Tables

### A.1.1 PSoC 5LP GPIO Header (J8) for CY8CKIT-042-BLE, CY8CKIT-044 and CY8CKIT-046

J8					
Pin	PSoC 5LP Signal	PSoC 5LP Description	Pin	PSoC 5LP Signal	PSoC 5LP Description
J8_01	PSoC 5LP_VDD	VDD	J8_02	P1[2]	Digital I/O
J8_03	P0[0]	Delta Sigma ADC + Input	J8_04	P0[1]	Delta Sigma ADC - Input
J8_05	P3[4]	SAR - Input	J8_06	P3[5]	SAR + Input
J8_07	P3[6]	Buffered VDAC	J8_08	P3[7]	Buffered VDAC
J8_09	P12[6]	UART RX	J8_10	P12[7]	UART TX
J8_11	P12[1]	SPI MISO/I2C SDA	J8_12	P3[0]	IDAC Output
J8_13	P12[0]	SPI SCLK/I2C SCL	J8_14	P12[5]	SPI MOSI
J8_15	P2[5]	SPI SSEL	J8_16	GND	GND

### A.1.2 PSoC 5LP GPIO Header (J8) for CY8CKIT-042 and CY8CKIT-040

J8					
Pin	PSoC 5LP Signal	PSoC 5LP Description	Pin	PSoC 5LP Signal	PSoC 5LP Description
J8_01	PSoC 5LP_VDD	VDD	J8_02	P1[2]	Digital I/O
J8_03	P0[0]	Delta Sigma ADC + Input	J8_04	P0[1]	Delta Sigma ADC - Input
J8_05	P3[4]	SAR - Input	J8_06	P3[5]	SAR + Input
J8_07	P3[6]	Buffered VDAC	J8_08	P3[7]	Buffered VDAC
J8_09	P12[6]	UART RX	J8_10	P12[7]	UART TX
J8_11	GND	SPI MISO/I2C SDA	J8_12	P3[0]	IDAC Output

## A.1.3 PSoC 5LP GPIO Header (J8 and J9) for CY8CKIT-059 and CY8CKIT-043

J9			J8		
Pin	PSoC 5LP Signal	PSoC 5LP Description	Pin	PSoC 5LP Signal	PSoC 5LP Description
J9_01	VBUS	Power/VDD	J8_01	GND	Ground
J9_02	GND	Ground	J8_02	P3[0]	GPIO
J9_03	P12[5]	GPIO	J8_03	P3[4]	GPIO
J9_04	P12[0]	GPIO/I2C_SCL	J8_04	P3[5]	GPIO
J9_05	P12[1]	GPIO/I2C_SDA	J8_05	P3[6]	GPIO
J9_06	P12[6]	GPIO/UART_RX	J8_06	P0[0]	GPIO
J9_07	P12[7]	GPIO/UART_TX	J8_07	P0[1]	GPIO

# Revision History



## Document Revision History

Document Title: KitProg User Guide			
Document Number: 001-96359			
Revision	Issue Date	Origin of Change	Description of Change
**	02/25/2015	RNJT	Initial version of KitProg User Guide.
*A	03/27/2015	RNJT	Updated the kit name to PSoC 4 M-Series Pioneer Kit. Updated link to PSoC 4200M webpage.
*B	04/02/2015	RNJT	Updated the incorrect links. Updated <a href="#">Figure 3-8</a> , <a href="#">Figure 3-9</a> , <a href="#">Figure 7-8</a> and <a href="#">Figure 8-3</a> .
*C	05/29/2015	RNJT	Updated <a href="#">Figure 1-1</a> . Added a Note in <a href="#">Introduction</a> , on page 4. Updated <a href="#">Table 2-1</a> . Updated the KitProg description in <a href="#">Table 3-1</a> . Added the chapter <a href="#">KitProg Mass Storage Programmer</a> , on page 14. Updated Step 3 in <a href="#">Enter or Exit the Mass Storage Programmer Mode</a> , on page 14. Updated Steps 2 and 3 in <a href="#">Programming Using the Mass Storage Programmer</a> , on page 14. Updated Frequently Asked Questions on KitProg Mass Storage Programmer.
*D	06/12/2015	RNJT	Added <a href="#">Figure 3-2</a> . Added <a href="#">Table A.1.3</a> in <a href="#">A.1 Pin Assignment Tables</a> .
*E	06/25/2015	MSUR	Added a note in Building a Normal Project for PSoC 5LP. Updated Step 2 in <a href="#">Restore PSoC 5LP Factory Program Using PSoC Programmer</a> , on page 46. Updated Step 3 in <a href="#">Restore PSoC 5LP Factory Program Using Bootloader Host Tool</a> , on page 48. Updated the following in <a href="#">Restore PSoC 5LP using MiniProg3</a> , on page 50: Updated title, added a Note.
*F	09/14/2015	MSUR	Removed the Note in Chapter <a href="#">Introduction</a> , on page 4. Updated <a href="#">Table 2-1</a> , <a href="#">Table 2-2</a> and <a href="#">Figure 7-8</a> . Updated <a href="#">4.3 Frequently Asked Questions on KitProg Mass Storage Programmer</a> . Updated <a href="#">7.2 Building a Normal Project for PSoC 5LP</a> . Updated Step 4 in Chapter <a href="#">KitProg USB-UART Bridge</a> , on page 18. Updated the Note and Step 4 in Chapter <a href="#">KitProg USB-I2C Bridge</a> , on page 27.

Document Title: KitProg User Guide			
Document Number: 001-96359			
Revision	Issue Date	Origin of Change	Description of Change
*F (Cont.)	09/14/2015	MSUR	<p>Updates Notes in <a href="#">7.1 Building a Bootloadable Project for PSoC 5LP</a>.</p> <p>Added a Note in <a href="#">8.1 KitProg Status LED Indication</a>.</p> <p>Updated the Note in <a href="#">8.2.1 PSoC 5LP is Programmed with a Bootloadable Application</a>.</p>
*G	09/21/2015	SRDS	<p>Updated the following sections:</p> <p><a href="#">KitProg Programmer/Debugger</a>, on page 7</p> <p><a href="#">KitProg USB-I2C Bridge</a>, on page 27</p> <p><a href="#">Troubleshooting the KitProg</a>, on page 45</p> <p><a href="#">PSoC 5LP GPIO Header (J8) for CY8CKIT-042-BLE, CY8CKIT-044 and CY8CKIT-046</a>, on page 51.</p> <p>Updated <a href="#">Table 2-1</a>.</p>