

User Manual

V1.0 – August 16, 2014

BestU

www.bestni.com/en



Copyright Statement:

- Unless otherwise noted, the eNet-ZB Serials includes but not limit to eNet-ZBP113, eNet-ZBP111, eNet-ZBP211, eNet-ZBP213.
- eNet, eNet-ZB Serials ZigBee wireless module and its related Intellectual Property owned by Shenzhen BestU Intelligent Technology Co.,Ltd.
- Without the permission of Shenzhen BestU Intelligent Technology Co.,Ltd ,No one can modify, distribute or copy any part of this document.

Legal Disclaimer:

- The source code, software, documents in company with eDuino UNO, Shenzhen BestU Intelligent Technology Co.,Ltd does not provide any guarantee; Not matter specific, connotative , including but not limited to specific purpose, all the risk should be undertook by end user; If coming out bug in the program, end user undertakes the all the necessary fee of service, modification, amends.

Version Updated:

Version	Updated Date	Description
1.0	2014-08-16	Released

Catalogue

1	Product Overview	4
1.1	Product Description	4
1.2	Package List	6
1.3	Development Kits	7
1.3.1	eDuino UNO Wireless Kit	7
1.3.2	Simple Wireless Kit	8
2	Hardware Feature	9
2.1	Dimensions	9
2.2	Pin-Out	10
2.3	Product Specification	12
2.4	Electric Property	13
2.4.1	Absolute Ratings	13
2.4.2	Operating Ratings	13
2.5	Typical Application	14
3	Configuration	15
3.1	Configuration command	15
3.2	Configuration software	15
4	Configuration Command	19
4.1	Configuration Command Format	19
4.2	Configuration Command Description	21
4.2.1	Set PANID (0x41)	21
4.2.2	Read PANID (0x01)	21
4.2.3	Set Device Type (0x42)	21
4.2.4	Read Device Type (0x02)	22
4.2.5	Read Device Short Address (0x03)	22
4.2.6	Set Communication Channel (0x44)	23
4.2.7	Read Communication Channel (0x04)	24
4.2.8	Set Serial Port Rate (0x45)	24
4.2.9	Read Serial Rate (0x05)	24
4.2.10	Set User ID (0x46)	25
4.2.11	Read User ID (0x06)	25
4.2.12	Set Transmission Mode (0x47)	25
4.2.13	Read Transmission Mode (0x07)	26
4.2.14	Set Transmission Power (0x48)	26
4.2.15	Read Transmission Power (0x08)	27
4.2.16	Read Device MAC Address (0x09)	27
4.2.17	System Reset (0x4A)	27

5	Data Transmission Mode.....	28
5.1	Transparent Transmission.....	28
5.1.1	Direct Transparent Transmission Mode.....	28
5.1.2	Transparent Transmission with Short Address	28
5.1.3	Transparent Transmission with MAC Address	29
5.1.4	Transparent Transmission with User ID.....	29
5.2	Point-to-Point Transmission	30
5.2.1	Point-to-Point Transmission with Short address	31
5.2.2	Point-to-Point Transmission with User ID	31
6	Module Network	32
6.1	ZigBee network Node.....	32
6.1.1	Coordinator	32
6.1.2	Router.....	32
6.1.3	End Device.....	33
6.2	ZigBee MESH Character.....	33
6.3	eNet-ZBP113 Network Test	34
6.3.1	Coordinator Configuration	34
6.3.2	Router settings	35
6.3.3	Joining A Network	36
6.3.5	Network Communication Test.....	37
7	Contact US	38
	Appendix I Default Parameters	39
	Appendix II FAQ.....	40
	Appendix III Technical Support	42

1 Product Overview

1.1 Product Description

eNet-ZBP113 module is a ZigBee embedded wireless module which is based on TI CC2530F256 and designed by BestU. The features of the chip, such as low power, excellent performance of a leading RF transceiver, SoC for IEEE 802.15.4 with 8051MCU, TI Z-Stack™ protocol stack and etc. make it a robust and complete ZigBee RF4CE remote-control solution.

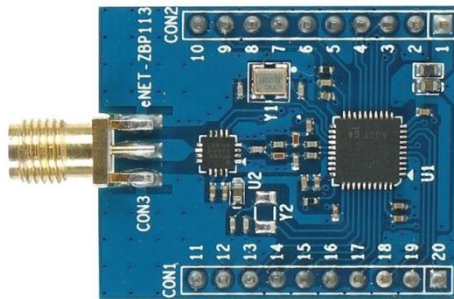

eNet-ZBP113 module operates in the unlicensed 2.4GHz ISM(Industrial, Scientific and Medical) band with data rate up to 250kb/s. Sixteen channels are allocated in the 2.4 GHz band, with each channel requiring 5 MHz of bandwidth. Self-organizing network and easy to use are the main features of eNet-ZBP113module. It is not necessary for you to understand complex ZigBee protocol. All the processing part of ZigBee protocol can be done internally by eNet-ZBP113 module. What you only need to do is to sending and receiving data via serial port, which can shorten lead time of product tremendously. Meanwhile eNet-ZBP113 module has the advantage of low-power and low-cost. As a consequence, eNet-ZBP113 module is the best choice for remote monitoring application, such as smart home, smart grid, industrial automation and security monitoring and etc.

BestU provides two kinds of ZigBee application protocols within the eNet-ZBP113 module, one for networking communication protocol, another for point-to-point communication protocol.

The eNet-ZB series modules are named according to their hardware and software features in the

following form:

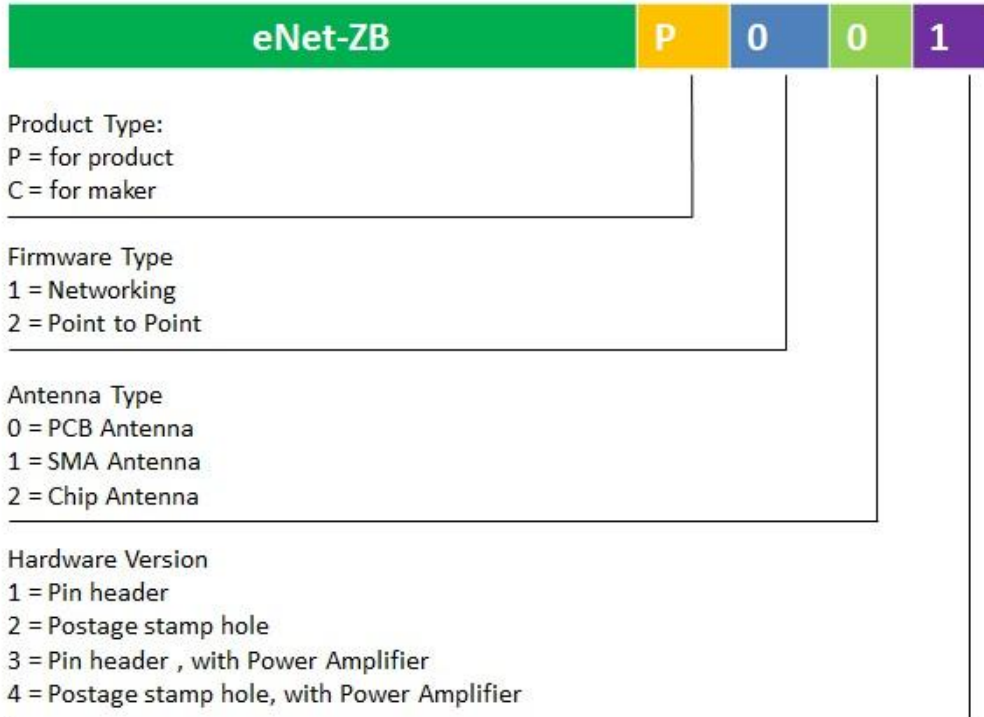



1.2 Package List

Table 1-1 Package list

Product Name	eNet-ZBP113
Standard Configuration	1) eNet-ZBP113 * 1 2) 2.4G Antenna *1
Optional Accessories	1) eDuino UNO 2) eNet-Test-A base board

1.3 Development Kits

There are two available development kits for eNet-ZBP113, eDuino UNO wireless kit and Simple Wireless kit.

1.3.1 eDuino UNO Wireless Kit

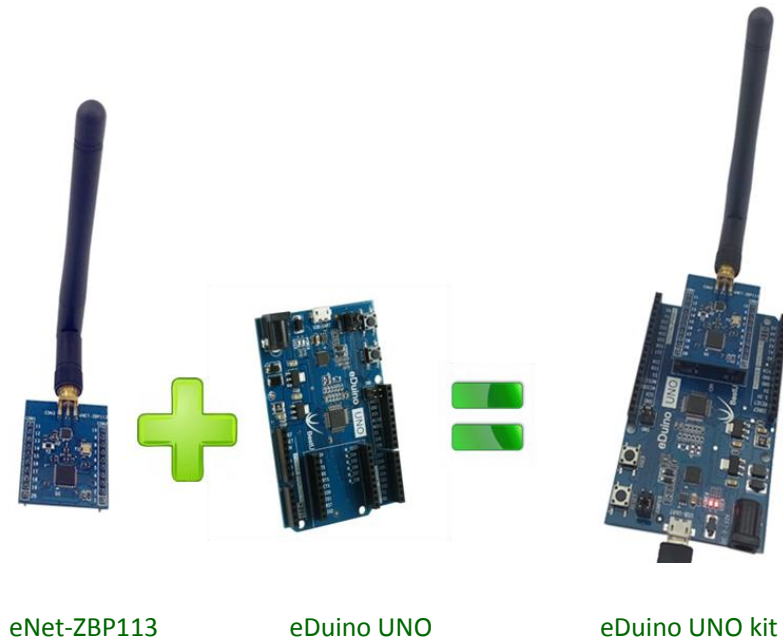

What's included in the eDuino UNO kit:

Table 1-2 Package List of eDuino UNO Kit

Part Description	Quantity / PCS
eNet-ZBP113	1
2.4GHz Antenna(2.5dBi)	1
eDuino UNO	1
Jumper	2



1.3.2 Simple Wireless Kit

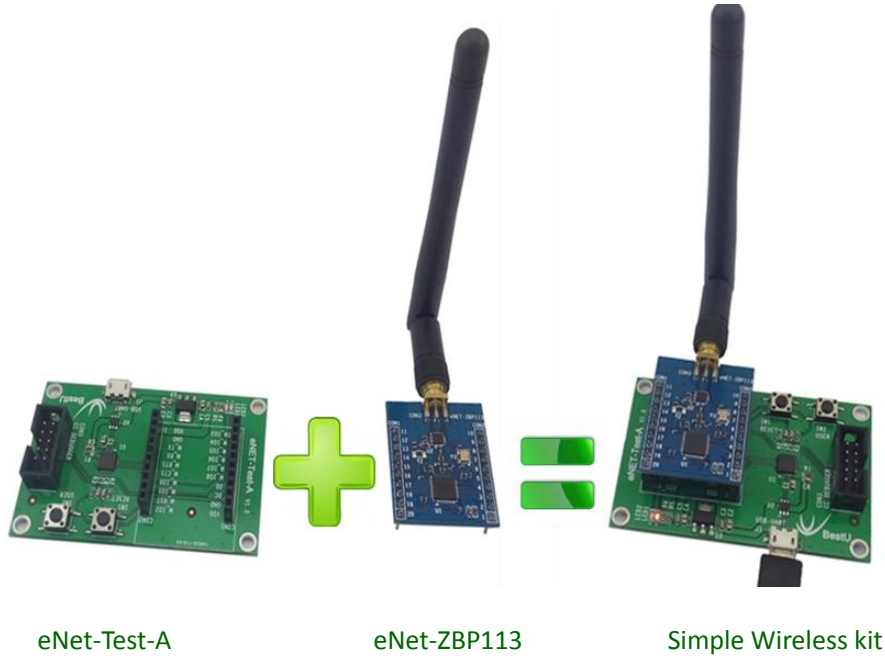

What's included in the Simple Wireless kit:

Table 1-3 Package List of Simple Wireless Kit

Part Description	Quantity / PCS
eNet-ZBP113	1
2.4GHz Antenna(2.5dBi)	1
eNet-Test-A	1



2 Hardware Feature

2.1 Dimensions

UNIT: mm

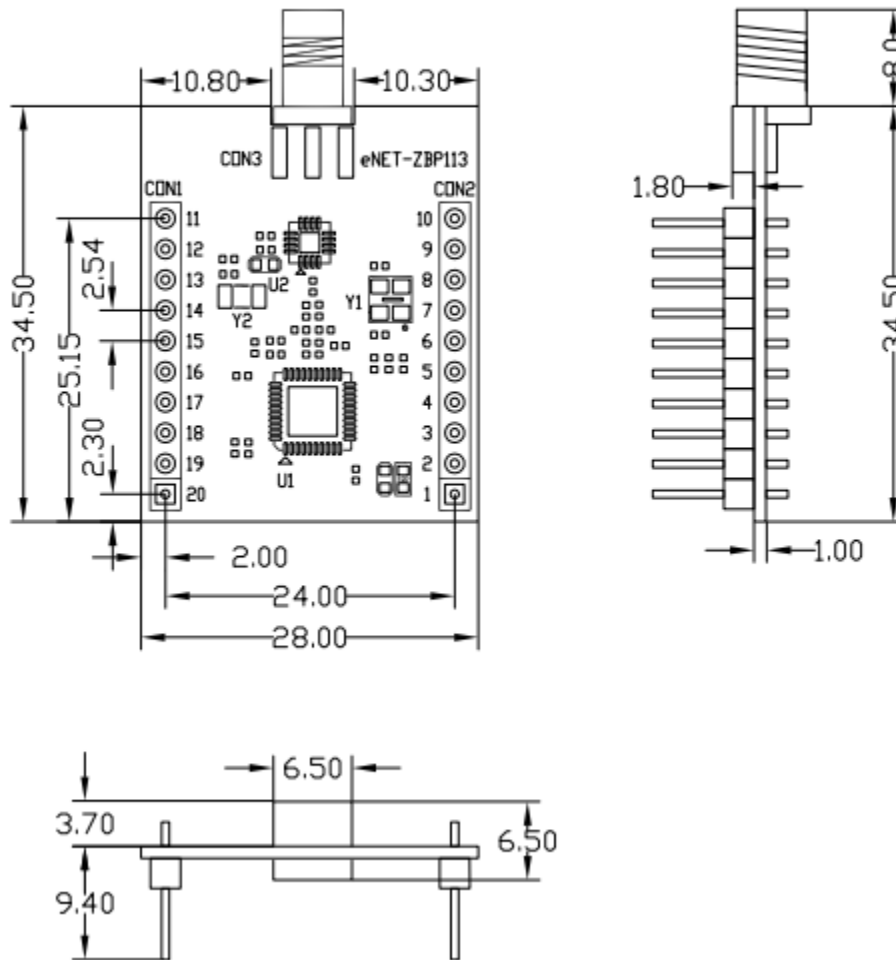

Figure 2-1 Dimensions

2.2 Pin-Out

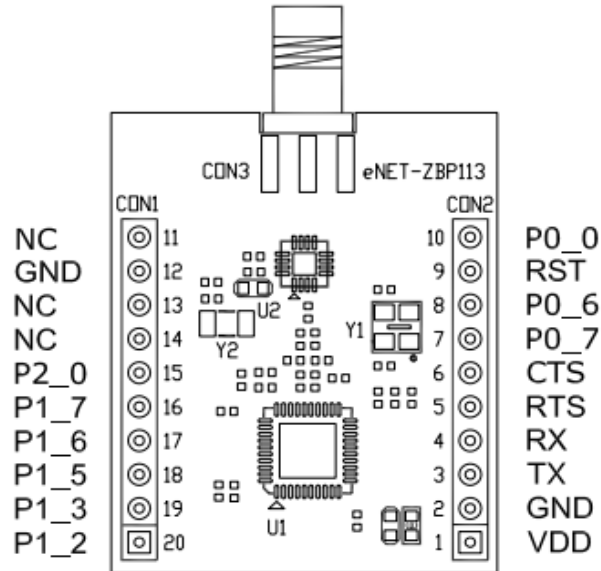

Figure 2-2 Pin out diagram

Table 2-1 Pin out description

Pin NO	Pin Name	Direction	Function	Remark
1	VDD	—	3.3V Power	
2	GND	—	GND	
3	TX	O	TXD	TTL (3.3V)
4	RX	I	RXD	TTL (3.3V)
5	RTS	—	NC	Reserve
6	CTS	—	NC	Reserve
7	P0_7	O	Communication State	1HZ square wave output
8	P0_6	O	Network Connection State	1HZ square wave output in specific case
9	RST	I	RST	Reserve.
10	P0_0	—	NC	Reserve
11	NC	—		
12	GND	—		
13	NC	—		
14	NC	—		
15	P2_0	—	NC	Reserve

ZigBee Wireless sensor network module

16	P1_7	—	NC	Reserve
17	P1_6	—	NC	Reserve
18	P1_5	—	NC	Reserve
19	P1_3	—	NC	Reserve
20	P1_2	—	NC	Reserve



Note: The reserved pins mentioned above do not need to pay attention in actual case. Only need to connect RX, TX, VDD and GND.

- PO_6 & PO_7 Output Specification
 - ◆ When configured as Coordinator

PO_6 outputs high level after reset. If ZigBee protocol working regularly, PO_6 outputs 1HZ square wave.

PO_7 outputs low level after reset. It will output a high level when receive data (The hold time is determined by the total receive time of a package data).
 - ◆ When configured as Router or End Devices

PO_6 outputs high level after reset. If the module has connected to a network, PO_6 will output 1HZ square wave.

PO_7 outputs low level after reset. It will output a high level when receive data (The holding time is determined by the total receive time of a package data).
- Serial port default settings:
 - ◆ Default baud rate: 38400bps

Recommended configuration: 38400bps

Baud rate range: 1200~38400bps.
 - ◆ Parity: None
 - ◆ Data: 8bit
 - ◆ Stop: 1bit
- Serial port data sending limitation

Max package size: 256 Byte.

2.3 Product Specification

Table 2-2 Product Specification

Typical DC Character (VDD=3.3V @ +25°C)		Remark
mA(TXD)	120mA(Max)	
mA(RXD)	40mA(Max)	
mA(Standby)	35 mA(Max)	
Typical RF Character		
Frequency Range	2.405GHz~2.480GHz	
RF Channel Quantities	16	
TX Rate	250Kbps(Max)	
RX sensitivity	-97dBm	
TX Power	10-20 dBm	Adjustable.20dBm default
Output Impedance	50 ohm	
Typical Networking Character		
Wireless Protocol	ZigBee 2007	
Network Node	65535(Max)	
Configured Node	Coordinator / Router	
Network Topology	Mesh Network (MESH)	
Distance	1600 meters	Visible, open transmission distance

2.4 Electric Property

2.4.1 Absolute Ratings

Table 2-3 Absolute Ratings

Parameter	Min	Max	Remark
Supply Voltage	-0.3V	3.6V	
Pin	-0.3V	VDD+0.6V	
Temp Range	-40°C	85°C	

2.4.2 Operating Ratings

Table 2-4 Operating Ratings

Parameter	Min	Max	Remark
Supply Voltage	2.7V	3.3V	
Temp Range	-40°C	85°C	
Humidity Range	0%	90%	No Condensation

2.5 Typical Application

eNet-ZB serials modules provide transparent data transmission through serial port. The typical application as below:

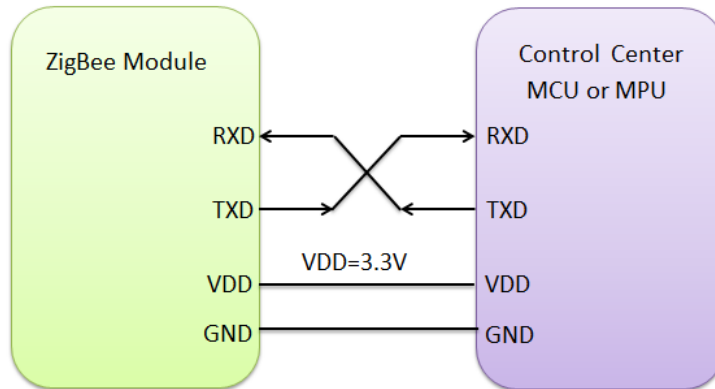

Figure 2-3 Typical Application Diagram

3 Configuration

eNet-ZBP113 provides convenient and efficient configuration methods. Users can reconfigure parameters with configuration commands or with configuration software tool on PC. The module will work with new parameters after reset.

3.1 Configuration command

Configuration commands are need if you want to change the configuration with using a MCU or MPU. Please refer to [Figure 2-3 Typical Application Diagram](#) and [4.2 configuration command description](#).

3.2 Configuration software

- 1) To connect the module with Serial Port. Click **Connect** button.

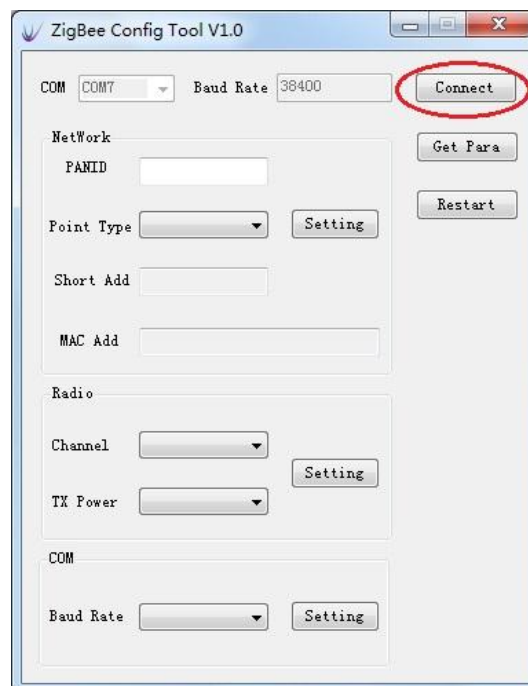

Figure 3-1 Connect the Module

- 2) Get the parameters from the Module.

Click the **Get Para** to get the current parameters of the module.

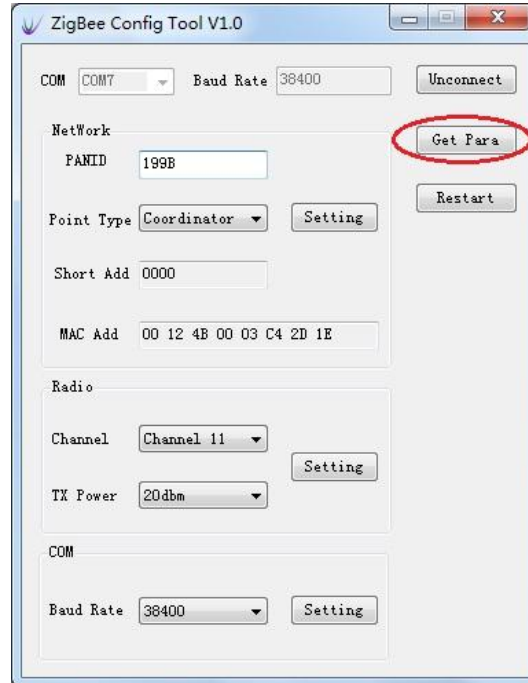

Figure 3-2 Get the parameters

- 3) Set the **Network** parameters.

Set the **PANID** or change the **Point type**. Click **Setting** button to finish the setting.

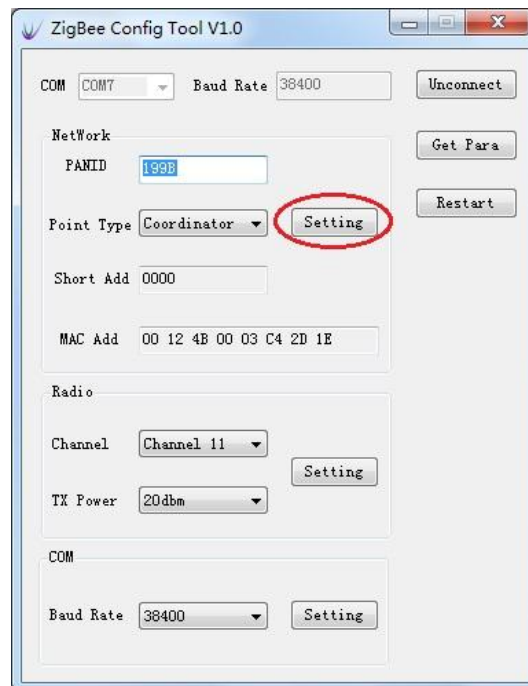

Figure 3-3 Set the network parameters

- 4) Set the **Radio** parameters.

Set the **Channel** or **TX Power** and click **Setting** to finish the setting.

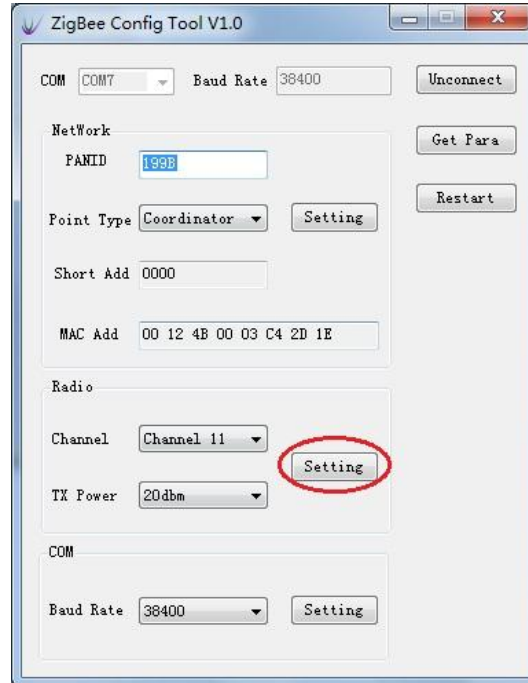

Figure 3-4 Set the Radio parameters

- 5) Set the **COM** parameters.

Set the **Baud Rate** and click the **Setting** to finish the Setting.

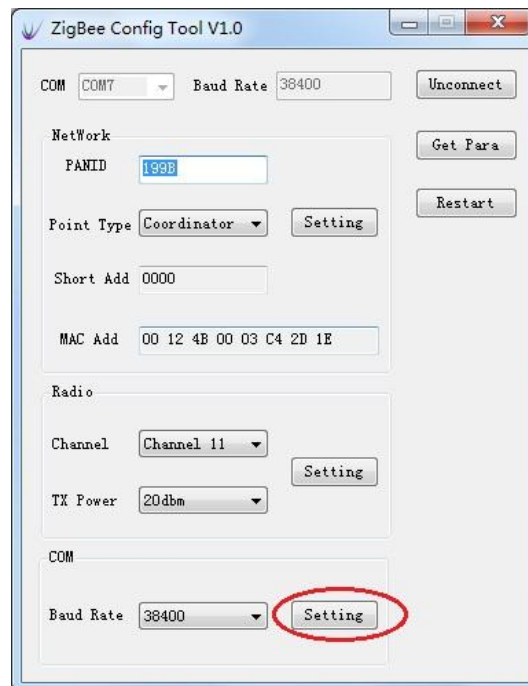

Figure 3-5 Set the UART parameters

- 6) **Restart** the module.

Click the **Restart** to make the module work with the parameters set by steps before after restart.

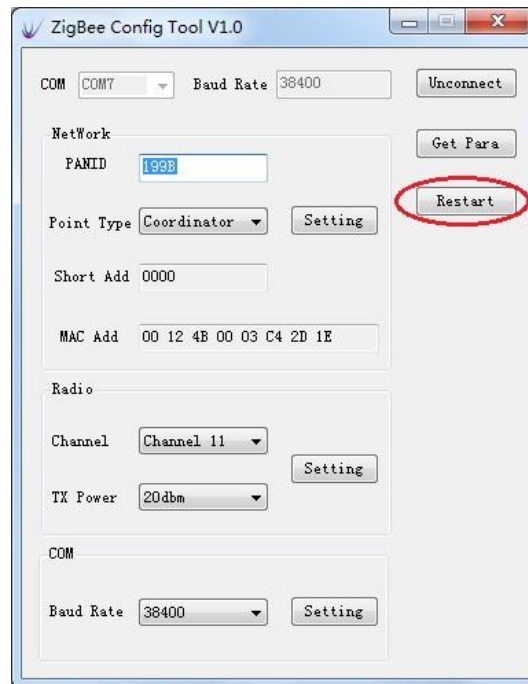

Figure 3-6 Restart module

- 7) Connect the module. Click **Get Para** and check the parameters is right .

4 Configuration Command

4.1 Configuration Command Format

Configuration Command is composed of **Beginning Characters**, **Length**, **Control Field**, **Data** and **Checksum**.

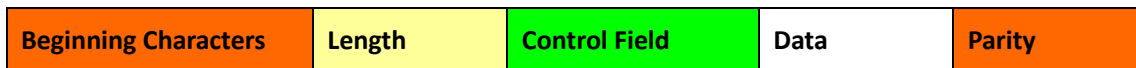

Figure 4-1 Configuration Command Format

- 1) **Beginning Characters**: Consists of 1byte, 0xFE by default.
- 2) **Length**: Consists of 1byte.It's the number of byte of Control Field and Data.
- 3) **Control Field**: It consists of 1byte and indicates the current command type. The configuration command list of eNet-ZB module is shown as below.

Table 4-1 Configuration Command List

NO.	Control Field (HEX)	Description
1	0x01	Read PANID
2	0x41	Set PANID
3	0x02	Read device type
4	0x42	Set device type
5	0x03	Read Short Address
6	0x04	Read communication channel
7	0x44	Set communication channel
8	0x05	Read Serial port baud rate
9	0x45	Set Serial port baud rate
10	0x06	Read user ID
11	0x46	Set user ID
12	0x07	Read transmission mode
13	0x47	Set transmission mode
14	0x08	Read transmission power

**ZigBee Wireless sensor network module**

NO.	Control Field (HEX)	Description
15	0x48	Set transmission power
16	0x09	Read device MAC address
17	0x4A	Reset system

- 4) **Data:** There are many kinds of command. For more details, refer to [4.2 Configuration Command description](#).
- 5) **Checksum:** it's octal arithmetic sum of **Beginning Character, Length, Control Field** and **User ID**.

4.2 Configuration Command Description

4.2.1 Set PANID (0x41)

This command is used to set PANID. The format of this command is as below:

Table 4-2 PANID Command format

Name	Length(Byte)	Description
PANID_H	1	High Byte of current PANID
PANID_L	1	Low Byte of current PANID

Example: The PANID need to be set as 0x199B.

Send: FE 03 41 19 9B F6

Right Response: FE 02 C1 00 C1

Error Response: FE 02 C1 01 C2

4.2.2 Read PANID (0x01)

This command is used to set PANID. For the format of this command, refer to [Table 4-2 PANID Command format](#).

Example: The current PANID is 0x199B.

Send: FE 01 01 00

Response: FE 03 81 19 9B 36

4.2.3 Set Device Type (0x42)

This command is used to configure device type (Coordinator or Router). The format of this command is as below:

Table 4-3 Device Type

Name	Length(Byte)	Description
Device Type	1	0x00: Coordinator
		0x01: Router

Example: The module needs to be set as Coordinator.

Send: FE 02 42 00 42

Right Response: FE 02 C2 00 C2

Error Response: FE 02 C2 01 C3

4.2.4 Read Device Type (0x02)

This command is used to read current device type. For the format of this command, refer to Table [4-3 Device Type](#).

Example: The module is Router type.

Send: FE 01 02 01

Response: FE 02 82 01 83

4.2.5 Read Device Short Address (0x03)

This command is used to read current short address. The format of this command is as follow:

Table 4-4 Short Address

Name	Length(Byte)	Description
ADDR_H	1	Current Network short address high byte
ADDR_L	1	Current Network short address low byte

Example: The device's network short address is 0x1ED6.

Send: FE 01 03 02

Response: FE 03 83 1E D6 78

4.2.6 Set Communication Channel (0x44)

This command is used to configure communication channel (there are 16 channels, which from 11 to 26, located in 2.4GHz band). The format of this command is as follow:

Table 4-5 Communication Channel

Name	Length(Byte)	Description
Channel	4	0x00000800 Channel 11, 2405MHz
		0x00001000 Channel 12, 2410MHz
		0x00002000 Channel 13, 2415MHz
		0x00004000 Channel 14, 2420MHz
		0x00008000 Channel 15, 2425MHz
		0x00010000 Channel 16, 2430MHz
		0x00020000 Channel 17, 2435MHz
		0x00040000 Channel 18, 2440MHz
		0x00080000 Channel 19, 2445MHz
		0x00100000 Channel 20, 2450MHz
		0x00200000 Channel 21, 2455MHz
		0x00400000 Channel 22, 2460MHz
		0x00800000 Channel 23, 2465MHz
		0x01000000 Channel 24, 2470MHz
		0x02000000 Channel 25, 2475MHz
		0x04000000 Channel 26, 2480MHz

Example: Set the communication channel as20.

Send: FE 05 44 00 00 10 00 57

Right Response: FE 02 C4 00 C4

Error Response: FE 02 C4 01 C5

4.2.7 Read Communication Channel (0x04)

This command is used to read current communication channel. For the format of return data, refer to [Table 4-5 Communication Channel](#).

Example: The current communication channel is 21.

Send: FE 01 04 03

Response: FE 05 84 00 00 20 00 A7

4.2.8 Set Serial Port Rate (0x45)

This command is used to set UART rate. The format of this command is as follow:

Table 4-6 Serial Port Rate

Name	Length(Byte)	Description
Serial Port Badu Rate	1	0x00:Baud Rate 9600
		0x01:Baud Rate 19200
		0x02:Baud Rate 38400
		0x03:Baud Rate 57600
		0x04:Baud Rate 115200

Example: Set Serial Rate as 115200.

Send: FE 02 45 04 49

Right Response: FE 02 C5 00 C5

Error Response: FE 02 C5 01 C6

4.2.9 Read Serial Rate (0x05)

This command is used to read current serial rate. For the format of this command, refer to [Table 4-6 Serial Port Rate](#).

Example: Current Serial Rate is 115200.

Send: FE 01 05 04

Response: FE 02 85 04 89

4.2.10 Set User ID (0x46)

This command is used to configure User ID. The format of this command is as follow:

Table 4-7 User ID

Name	Length(Byte)	Description
USERID_H	1	Current User ID High Byte
USERID_L	1	Current User ID low Byte

Example: Set user ID as 0x0045.

Send: FE 03 46 00 45 8C

Right Response: FE 02 C6 00 C6

Error Response: FE 02 C6 01 C7

4.2.11 Read User ID (0x06)

This command is used to read User ID. For the format of this command, refer to [Table 4-7 User ID](#).

Example: Current User ID is 0x0045.

Send: FE 01 06 05

Response: FE 03 86 00 45 CC

4.2.12 Set Transmission Mode (0x47)

This command is used to configure transmission mode. The format of this command is as follow:

Table 4-8 Transmission Mode

Name	Length(Byte)	Description
Transfer mode	1	0x00:Transparent transmission
		0x01:Transparent transmission with short address
		0x02: Transparent transmission with MAC address
		0x03: Transparent transmission with user ID
		0x04: Point-to-point transmission with short address

ZigBee Wireless sensor network module

Name	Length(Byte)	Description
		0x05: Point-to-point transmission with User ID

Example: Set transmission mode as transparent transmission.

Send: FE 02 47 00 47

Right Response: FE 02 C7 00 C7

Error Response: FE 02 C7 01 C8

4.2.13 Read Transmission Mode (0x07)

This command is used to read current transmission mode. For the format of this command, refer to [Table 4-8 Transmission Mode](#).

Example: Current transmission mode is transmission transmission.

Send: FE 01 07 06

Response: FE 02 87 00 87

4.2.14 Set Transmission Power (0x48)

This command is used to set wireless transmission power. The format of this command is as follow:

Table 4-9 Transmission Power

Name	Length(Byte)	Description
Transfer mode	1	0x00 Transmission Power 3dbm
		0x01 Transmission Power 2dbm
		...
		0x19 Transmission Power -22dbm

Example: Set Transmission power as-1dbm

Send: FE 02 48 04 4C

Right Response: FE 02 C8 00 C8

Error Response: FE 02 C8 01 C9

4.2.15 Read Transmission Power (0x08)

This command is used to read current transmission power. For the format of this command, refer to [Table 4-9 Transmission Power](#).

Example: The current transmission power is-1dbm.

Send: FE 01 08 07

Response: FE 02 88 04 8C

4.2.16 Read Device MAC Address (0x09)

This command is used to read MAC address. The format of this command is as follow:

Table 4-10 MAC Address

Name	Length(Byte)	Description
MAC	8	Current MAC Address

Example: Current MAC address is 00 EF DF 16 AA 54 4A 32.

Send: FE 01 09 08

Response: FE 09 89 32 4A 54 AA 16 DF EF 00 EE

4.2.17 System Reset (0x4A)

This command is used to reset system. The Module will reset in 1s when it receive the reset command.

Example:

Send: FE 01 4A 49

Right Response: FE 02 CA 00 CA

Error Response: FE 02 CA 01 CB

5 Data Transmission Mode

eNet-ZBP113 has two transmission mode, transparent transmission and point-to-point transmission. In transparent transmission mode, the data can transmit from Coordinator to Router, or from Router to Coordinator, but cannot from Router to Router. In point-to-point transmission mode, data can be transmitted between any two nodes response, include the case of Router to Router.



Note: The maximum length of Data package should be less than 256 Byte

5.1 Transparent Transmission

Transparent transmission can be subdivided into four modes:

- Direct transparent transmission mode
- Transparent transmission mode with short address
- Transparent transmission mode with MAC address
- Transparent transmission mode with user ID



Note: In transparent transmission mode, data can be transmitted only between Coordinator and Router. The data can be received by all the routers while it's sent from Coordinator to Router since it is broadcast.

5.1.1 Direct Transparent Transmission Mode

Direct Transparent Transmission mode is default data transmission mode for eNet-ZBP113. When eNet-ZBP113 is in this mode, data package that does not match the format shown as [Figure 4-1 Configuration Command Format](#) will be transmitted by ZigBee network.

5.1.2 Transparent Transmission with Short Address

When the module is in this mode, the short address (2 bytes) of the module will be added on the end of original data before the package is transmitted. The format is as follow:



Figure 5-1 Transparent transmission mode with short address

It needs to be set as transparent transmission mode with short address before using the module in this mode. Refer to section [4.2.12 Set Transmission Mode\(0x47\)](#) and the data should not be same with the command that listed in [Table 4-1 Configuration Command List](#).

Example: Short Address 0x199B

Original Data: 12 34 56 78 90 AB CD EF

Transferred Data: 12 34 56 78 90 AB CD EF **19 9B**

5.1.3 Transparent Transmission with MAC Address

When the module is in this mode, the MAC address (8 bytes) of the module will be added on the end of original data before the package be transmitted. The format is as follow:

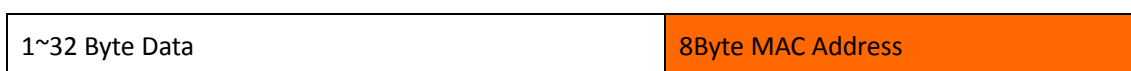

Figure 5-2 Transparent Transmission Data with MAC

It needs to be set as transparent transmission mode with MAC address before using the module in this mode. Refer to section [4.2.12 Set Transmission Mode\(0x47\)](#) and the data should not be same with the command that listed in [Table 4-1 Configuration Command List](#).

Example: Current MAC address is 00 EF DF 16 AA 54 4A 32

Original Data: 12 34 56 78 90 AB CD EF

Transferred data: 12 34 56 78 90 AB CD EF **00 EF DF 16 AA 54 4A 32**

5.1.4 Transparent Transmission with User ID

When the module is in this mode, the User ID (2 bytes) of the module will be added on the end of original data before the package be transmitted. The format is as follow:



Figure 5-3 Transparent Transmission Data Format with User ID

It needs to be set as transparent transmission mode with User ID before using the module in this mode. Refer to section [4.2.12 Set Transmission Mode\(0x47\)](#) and the data should not be same

with the command that listed in [Table 4-1 Configuration Command List](#).

Example: User ID is 0x0045.

Original Data: 12 34 56 78 90 AB CD EF

Transferred Data: 12 34 56 78 90 AB CD EF **00 45**

5.2 Point-to-Point Transmission

Point-to-point transmission is composed of beginning character, Length, Short Address/User ID, Data.

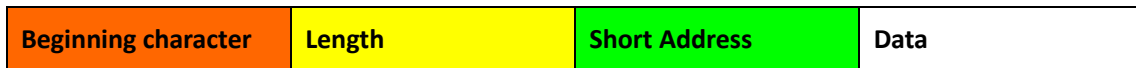

Figure 5-4 Point-to-point transmission format

Table 5-1 Point-to-point transmission format

Name	Length(Byte)	Description
Beginning Character	1	Fixed as 0xFD
Length	1	Including length of Short Address/User ID, Data
Address	2	Byte: short address or user ID high byte
		Byte2:short address or user ID low byte
Data	1~32	1~32bytes user data

Point-to-point transmission can be subdivided into two modes:

- Point-to-point transmission by short address
- Point-to-point transmission by user ID



Note: When the module is in point-to-point transmission mode, the data which does not match the format that shown as [Figure 5-4 Point-to-point transmission format](#) or is same with the command that listed in [Table 4-1 Configuration Command List](#) will be transmitted in transparent transmission mode. Refer to [section 5.1 Transparent Transmission Mode](#).

5.2.1 Point-to-Point Transmission with Short address

Data can be exchanged between any two nodes in this mode. The short address (2 bytes) of the module will be added on the end of original data before the package is transmitted.

Example: Tx module's short address is 0x0045. Rx module's short address is 0x0067.

Original Data: FD 0A 00 67 12 34 56 78 90 AB CD EF

Tx module send: FD 0A 00 67 12 34 56 78 90 AB CD EF 00 45

Only the module which short address is 0x0067 can receive this data package.

5.2.2 Point-to-Point Transmission with User ID

In this mode, the Coordinator can communicate with any Router while Router only can communicate with Coordinator. The User ID (2 bytes) of the module will be added on the end of original data before the package is transmitted.

Example: Tx module's user ID is 0x0045. Rx module's user ID is 0x0067.

Original Data: FD 0A 00 67 12 34 56 78 90 AB CD EF

Tx module send: FD 0A 00 67 12 34 56 78 90 AB CD EF 00 45

Only Router which User ID is 0x0067 can receive this data.

6 Module Network

6.1 ZigBee network Node

ZigBee devices are of three node types: Coordinator, Router and End Device.

6.1.1 Coordinator

The Coordinator forms the root of the network tree and might bridge to other networks. It assigns short address for child node when they join the network. In this type of network, ZigBee coordinator typically keeps continuously active and no low power state, requiring a more robust power supply. There is exactly one ZigBee Coordinator in each network since it is the device that started the network originally. There should be different PANID for different network's Coordinator, so if a network with the same PANID is detected in the same room, the PANID of Coordinator which power on latter will automatically add 1.

6.1.2 Router

As well as running an application function, a Router can act as an intermediate router, passing on data from other devices. It can also assign short address for child node. In a ZigBee network, ZigBee Router typically keeps continuously active and no low power state.

A network with one Coordinator and more than one Router can be called ZigBee MESH network. The data sent by any node will automatically route to the target node. The short address that Router obtain when it join a MESH network will be fixed and can be used as the address of point to data transmission.

Even Coordinator power down, Router can still maintain the network and communicate with each other. A new node can obtain short address from Router when they join the network. Router is normally called FFD (Full Function Device)

6.1.3 End Device

An End Device can join an existing ZigBee network. It contains just enough functionality to talk to the parent node (either the Coordinator or a Router). It cannot relay data from other devices. This relationship allows the node to be asleep a significant amount of the time thereby giving long battery life. There may be more than one End Device in a ZigBee network. They ask the parent node if there is any data or task need to deliver to it when it wakes up from sleep mode. It's suitable for applications such as periodic communication with small amount of data.

6.2 ZigBee MESH Character

ZigBee MESH main character:

- Consists of 1 x Coordinator and N x Router
- Each node can send and receive data, and passing on data from other nodes as a router
- Any nodes can communicate, even though other nodes are out of power overall (including coordinator), the two nodes can communicate with each other.
- Each node in the network (Coordinator or Router) can maintain the network. As long as there is one node is running, the new node can join the network by this node
- The new node obtains automatically the short address and keep it fixed.
- Path calculation is automatically. Data transmission does not rely on a certain node.

6.3 eNet-ZBP113 Network Test

eNet-ZBP113 can act as Coordinator and Router. Since the Router also act as END device, END device is not necessary here. A ZigBee Network contain one Coordinator and one or more Router. All the nodes in a same network share the same PANID. For default type configuration of eNet-ZBP113, refers to [Appendix I Module Default Parameters](#).

6.3.1 Coordinator Configuration

Here is an example that shows how to configure a module as a Coordinator.

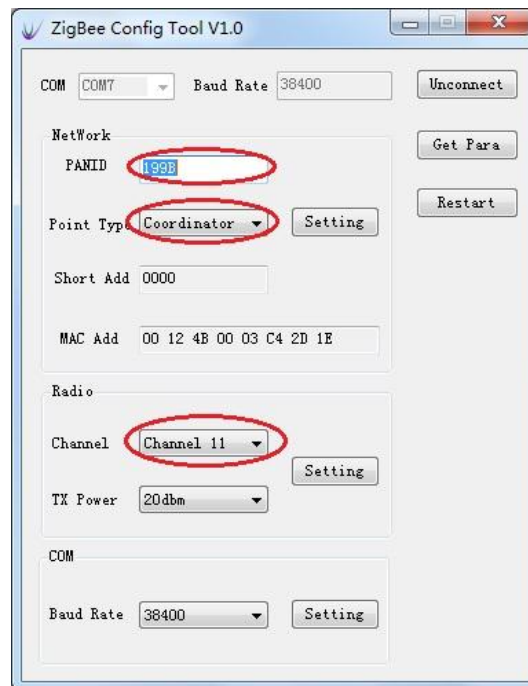

Figure 6-1 Coordinator Settings

6.3.2 Router settings

Here is an example that shows how to configure a module as a Router.

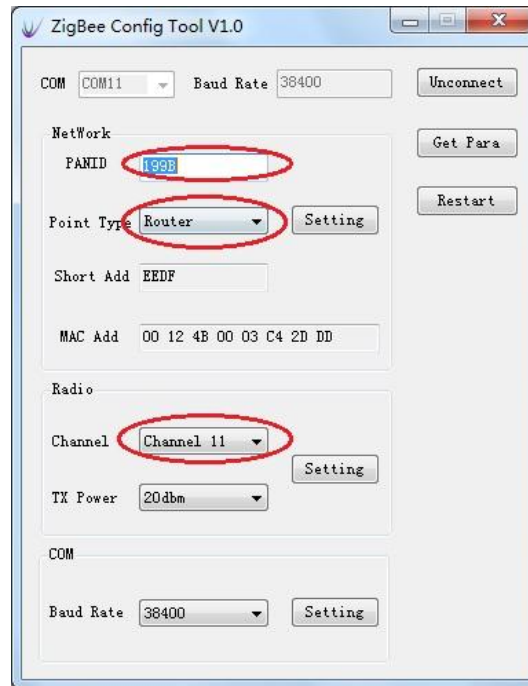

Figure 6-2 Router Settings

6.3.3 Joining A Network

Power the Coordinator before the Router. P0_6 of both modules will output a 1Hz pulse to indicate network establishing complete. Check the **Short Add** of the Router by click on **Get para** button. If the **Short Add** isn't 0xFFFE, the Router has joined the network.

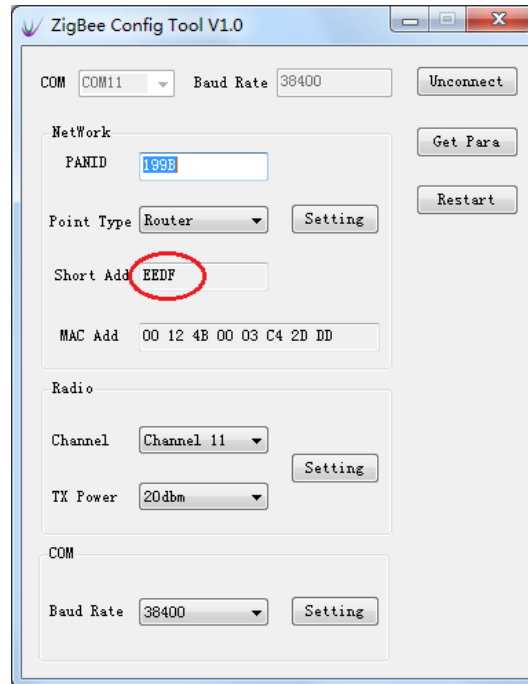

Figure 6-3 Router have joined the network

6.3.5 Network Communication Test

When the network is available, data can exchange between the Coordinator and Router.

Open HyperTerminal on PC. Send strings “Hello Router” from Coordinator and the Router receives the strings. Both the Coordinator and Router can send or receive data.

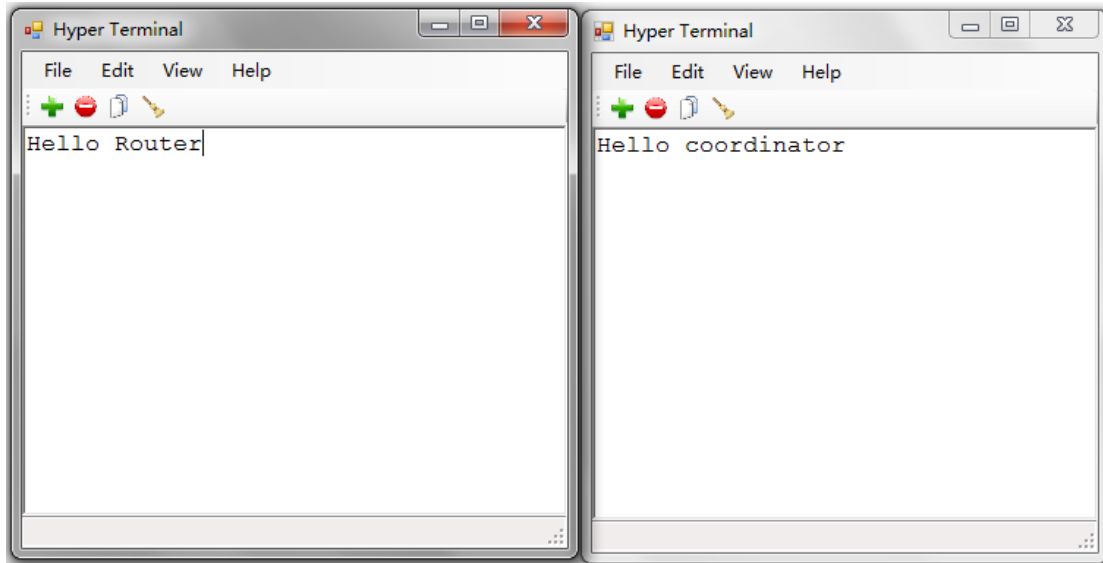

Figure 6-4 Network Communication Test

7 Contact US

Technical Support

Tel: +86-755-22360817 / 13088872937

Email: support@bestni.com

Sale Support

Tel: +86-755-22360817

Email: sales@bestni.com / 13088872937

About BestU

Hi, we are BestU, we believe that you will be more happy and better with our products and services.

Our technology focused on IoT and open hardware.

We own the “Brain”, the microcontroller module for Industry Area, like a brain to manipulate the various branches.

We own the “Brick”, providing base IOT modules like WIFI/ZigBee/NFC/BLE etc. to bring down your development threshold, to quickly build your product prototype

We own the “Low Kit”, providing the lowest hardware for you to evaluate and build your product.

Better because of your good, we hope the products and services we have can make you be more excellent!

More info please visit www.bestni.com



Appendix I Default Parameters

Parameter Name	Default Value
PANID	0x199B
Communication Channel	11
Module Type	Coordinator
Transmission Power	20 dBm
Serial Rate	38400 bps
Transmission Mode	Transparent Transmission

Appendix II FAQ

1) What is PAN ID?

PAN ID is an ID for ZigBee network. Different ZigBee network has different PAN ID. The ZigBee networks with different ID in the same room will not interfere with each other..

2) What is network short address of ZigBee? How does it work?

The network address is assigned by Coordinator when a device connects to network. The short address of Coordinator is always 0x0000. The short address is the address of transmitter or receiver. If the short address is not 0xFFFF, such as 0x0039, it means that the module has joined a network.

3) What are Coordinator, Router, End Device?

ZigBee network node has three network forms: Coordinator, Router, End Device.

- Coordinator (Network coordinator node)

Used to create a ZigBee network (WPAN Formation) and assign short address.

- Router(Network router node)

Used to passing on data from other devices, find the most suitable routing path and assign short address when a node joins the network.

- End Device(Network router node)

Contains just enough functionality to talk to the parent node (either the Coordinator or a Router); it cannot relay data from other devices. This relationship allows the node to be asleep a significant amount of the time thereby giving long battery life.

4) How to control eNet-ZBP113 ZigBee module by microcontroller?

eNet-ZBP113 ZigBee can connect to any microcontroller with serial port. Microcontroller communicates with and configures the module by serial port.

The level of eNet-ZBP113 is 3.3V. It can be connected with 3.3V level MCU directly. If using a 5V level MCU, level shifter should be concerned.

5) Why the PAN ID that read from module will add 1 automatically after you changed it?

It happens actually. Coordinator can creates a network that contains one or more Routers.

Router can maintain part of network when the Coordinator is power off. Since all device in ZigBee network share the same PAN ID, the Coordinator will detect a network with same PAN ID that maintained by Router after it power on again. In order to avoid conflict, this Coordinator will add 1 to its PAN ID and create a new network.

How to Solve?

There are some choices:

- a) Modify the PAN ID of Router or End Device to the old PAN ID +1 or 0xFFFF and make Router or End Device join the new network created by Coordinator.
- b) Turn off all nodes except the Coordinator. Modify the PAN ID of the Coordinator and restart the Coordinator. Power other nodes.
- 6) Advantage and Disadvantage of PAN ID = 0xFFFF.

Advantage: if modify the PAN ID of Router to 0xFFFF, this node will restart and join a network automatically. LQ determines which network to join without any user intervention.

Disadvantage: if there is more than one network, the node will join a network randomly.

- 7) Why the PAN ID read from the module is 0xFFFE after reset while you intent to set it as 0xFFFF?

What you read from the module is the current PAN ID by the Read PAN ID command. If the node, Router or End Device has joined a network, the PAN ID will be same with Coordinator's; otherwise it will be 0xFFFE.

- 8) What is the MAC address?

MAC address is known as IEEE address, a 64 bits unique address purchased from IEEE organization. It can be a an ID for ZigBee module.

Appendix III Technical Support

Customers who buy products from Best U or the Formal Agent authorized can enjoy the technical services as below:

- Six months warranty
 - Free technical support
 - Repair Service
 - Free software upgrading service
 - Free software code
 - Enjoy preferential policy when purchasing.
 - OEM/ODM service
- ⊘ Cannot enjoy free repair service under following cases, we will have the service fee according to the matter of fact.
- Cannot provide valid purchasing certificate.
 - Exceed free Six months warranty.
 - Software and Hardware issues occur in your own develop.
 - Issues by modifying software sources
 - Fault and damage by unauthorized use of hardware, error power on, error operation
 - Liquid inlet, damp, mildew, erosion.
 - Fault and Damage by impact, crush, flop, scratch but not product quality.
 - Irresistible natural factors.
 - Commitment to customers not by Best U, should be fulfilled by people who promise, Best U does not assume any responsibilities.