

SACB-8/ 8-L- 5,0PUR

Order No.: 1695168



<http://eshop.phoenixcontact.de/phoenix/treeViewClick.do?UID=1695168>

Sensor/actuator box, M12 female connector, Number of slots: 8, Number of positions: 4, Slot assignment: Single, Status indication: Yes, pnp 180°, PUR/PVC, Cable length: 5 m, Shielding: No

Commercial data	
GTIN (EAN)	 4 017918 177645
sales group	D101
Pack	1 pcs.
Customs tariff	85366990
Catalog page information	Page 114 (PC-2009)

Product notes

WEEE/RoHS-compliant since:
03/15/2006



<http://www.download.phoenixcontact.com>
Please note that the data given here has been taken from the online catalog. For comprehensive information and data, please refer to the user documentation. The General Terms and Conditions of Use apply to Internet downloads.

Technical data	
General data	
Rated voltage	24 V DC
Max. operating voltage U_{max}	30 V DC
Current carrying capacity per I/O signal	2 A
Current carrying capacity per slot	4 A

Total rated current	12 A
Number of positions	4
Number of slots	8
Degree of protection	IP65/IP67
Inflammability class acc. to UL 94	V0
Ambient temperature (operation)	-25 °C ... 75 °C
Sensor/actuator connection system	M12 female connector

Local diagnostics function

Local diagnostics	Supply voltage Green LED
	Status display I/O Yellow LED

Master cable data

Type of connection	Fixed connection
Length of cable	5 m
Cable type	Master cable suitable for flexible cable conduit
Signal line cross section	8x 0.34 mm ²
AWG signal line	22
Conductor structure signal line	42x 0.10 mm
Power supply cross section	3x 0.75 mm ²
AWG power supply	19
Conductor structure, voltage supply	96x 0.10 mm
External diameter	9.2 mm
Max. bending cycles	1500000
Bending radius	95 mm
Traversing path	2 m
Traversing rate	2 m/s
Ambient temperature (operation)	-40 °C ... 90 °C (for fixed installation)
	-5 °C ... 80 °C (for flexible installation)
Tightening torque slot sensor/actuator cable	0.4 Nm
Tightening torque screw plug	0.4 Nm

Insulation material

Housing material	PA
Contact material	CuSn
Contact surface material	Ni/Au
Contact carrier material	PA

Material, O-ring	NBR
Pin assignment	
Slot/position = Wire color or connection	1 / 4 (A) = WH
	2 / 4 (A) = GN
	3 / 4 (A) = YE
	4 / 4 (A) = GY
	5 / 4 (A) = PK
	6 / 4 (A) = RD
	7 / 4 (A) = BK
	8 / 4 (A) = VT
	1-8 / 1 (+ 24 V) = BN
	1-8 / 3 (0 V) = BU
	1-8 / 5 (PE) = GN/YE

Certificates / Approvals



Certification CUL, GOST, UL

Accessories

Item	Designation	Description
Marking		
2809128	ZBN 18:UNBEDRUCKT	Unprinted marker labels, strips with 5 labels for individual labeling with M-PEN or CMS system, for terminal block width: 17.5 mm, color: White
Protection and sealing elements		
1680539	PROT-M12	An M12 screw plug for the unoccupied M12 sockets of the sensor/ actuator cable, boxes and flush-type connectors
Tools		
1208432	SAC BIT M12-D15	Nut for assembling sensor/actuator cables with M12 connector and for M12 connectors with QUICKON fast connection technology, for 4 mm hexagonal drive

1208445	SACC BIT M12-D20	Nut for assembling SACC M12 connectors for free assembly, excluding M12 connectors with QUICKON fast connection technology, for 4 mm hexagonal drive
1208429	TSD 04 SAC	Torque screwdriver, with preset torque of 0.4 Nm and 4 mm hexagonal drive for M12 connectors

Diagrams/Drawings

Dimensioned drawing

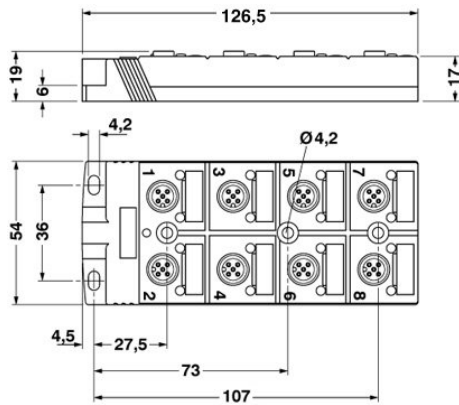

Circuit diagram

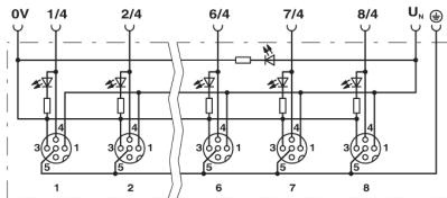

Schematic diagram

M12 slot, socket, 4-pos.

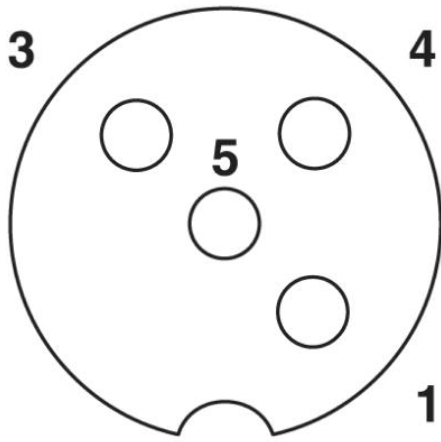

Address

PHOENIX CONTACT Inc., USA
586 Fulling Mill Road
Middletown, PA 17057, USA
Phone (800) 888-7388
Fax (717) 944-1625
<http://www.phoenixcon.com>



© 2010 Phoenix Contact
Technical modifications reserved;