

Silicon carbide Power MOSFET 1200 V, 12 A, 520 mΩ (typ., T_J = 150 °C) in an HiP247™ package

Datasheet - production data

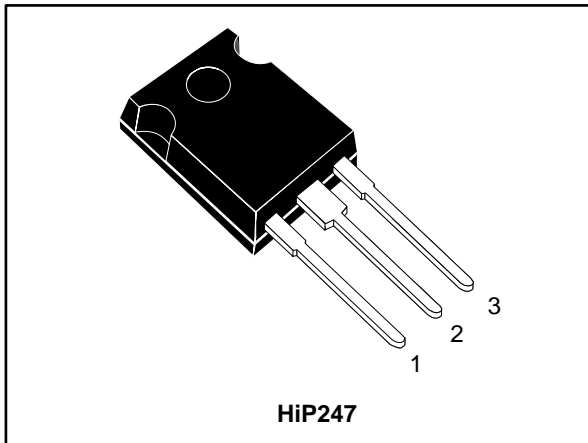
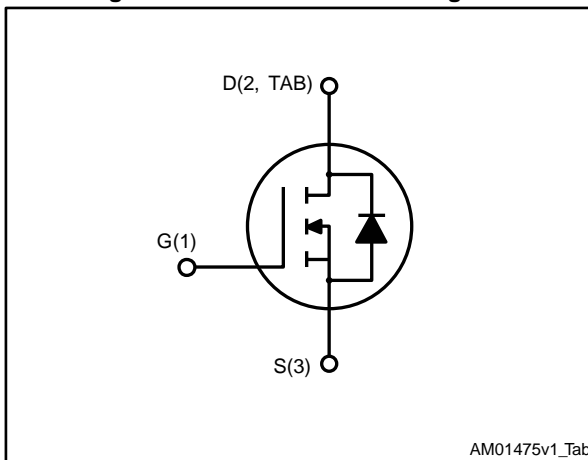

Figure 1: Internal schematic diagram



Features

- Very tight variation of on-resistance vs. temperature
- Slight variation of switching losses vs. temperature
- Very high operating temperature capability (T_J=200 °C)
- Very fast and robust intrinsic body diode
- Low capacitance

Applications

- Solar inverters, UPS
- Motor drives
- High voltage DC-DC converters
- Switch mode power supplies

Description

This silicon carbide Power MOSFET is produced exploiting the advanced, innovative properties of wide bandgap materials. This results in unsurpassed on-resistance per unit area and very good switching performance almost independent of temperature. The outstanding thermal properties of the SiC material, combined with the device's housing in the proprietary HiP247™ package, allows designers to use an industry-standard outline with significantly improved thermal capability. These features render the device perfectly suitable for high-efficiency and high power density applications.

Table 1: Device summary

Order code	Marking	Package	Packaging
SCT10N120	SCT10N120	HiP247™	Tube



The device meets ECOPACK standards, an environmentally-friendly grade of products commonly referred to as "halogen-free". See [Section 6: "Package information"](#).

Contents

1	Electrical ratings	3
2	Electrical characteristics	4
	2.1 Electrical characteristics (curves).....	6
3	Test circuits	10
4	Package information	11
	4.1 HiP247™ package information.....	11
5	Revision history	13

1 Electrical ratings

Table 2: Absolute maximum ratings

Symbol	Parameter	Value	Unit
V_{DS}	Drain-source voltage	1200	V
V_{GS}	Gate-source voltage	-10 to 25	V
I_D	Drain current (continuous) at $T_C = 25\text{ °C}$	12	A
I_D	Drain current (continuous) at $T_C = 100\text{ °C}$	10	A
$I_{DM}^{(1)}$	Drain current (pulsed)	24	A
P_{TOT}	Total dissipation at $T_C = 25\text{ °C}$	150	W
T_{stg}	Storage temperature range	-55 to 200	°C
T_j	Operating junction temperature range		°C

Notes:

⁽¹⁾Pulse width limited by safe operating area.

Table 3: Thermal data

Symbol	Parameter	Value	Unit
$R_{thj-case}$	Thermal resistance junction-case max	1.17	°C/W
$R_{thj-amb}$	Thermal resistance junction-ambient max	40	°C/W

2 Electrical characteristics

($T_{CASE} = 25\text{ °C}$ unless otherwise specified).

Table 4: On/off states

Symbol	Parameter	Test conditions	Min.	Typ.	Max.	Unit
$V_{(BR)DSS}$	Drain-source breakdown voltage	$V_{GS} = 0\text{ V}$, $I_D = 1\text{ mA}$	1200			V
I_{DSS}	Zero gate voltage drain current	$V_{DS} = 1200\text{ V}$, $V_{GS} = 0\text{ V}$			10	μA
		$V_{DS} = 1200\text{ V}$, $V_{GS} = 0\text{ V}$, $T_J = 200\text{ °C}$ ⁽¹⁾			100	μA
I_{GSS}	Gate-body leakage current	$V_{DS} = 0\text{ V}$, $V_{GS} = -10\text{ to }22\text{ V}$			100	nA
$V_{GS(th)}$	Gate threshold voltage	$V_{DS} = V_{GS}$, $I_D = 250\text{ }\mu\text{A}$	1.8	3.5		V
$R_{DS(on)}$	Static drain-source on-resistance	$V_{GS} = 20\text{ V}$, $I_D = 6\text{ A}$		500	690	m Ω
		$V_{GS} = 20\text{ V}$, $I_D = 6\text{ A}$, $T_J = 150\text{ °C}$		520		m Ω
		$V_{GS} = 20\text{ V}$, $I_D = 6\text{ A}$, $T_J = 200\text{ °C}$		580		m Ω

Notes:

⁽¹⁾Defined by design, not subject to production test.

Table 5: Dynamic

Symbol	Parameter	Test conditions	Min.	Typ.	Max.	Unit
C_{iss}	Input capacitance	$V_{DS} = 400\text{ V}$, $f = 1\text{ MHz}$, $V_{GS} = 0\text{ V}$	-	290	-	pF
C_{oss}	Output capacitance		-	30	-	pF
C_{rss}	Reverse transfer capacitance		-	9	-	pF
Q_g	Total gate charge	$V_{DD} = 800\text{ V}$, $I_D = 6\text{ A}$, $V_{GS} = 0\text{ to }20\text{ V}$	-	22	-	nC
Q_{gs}	Gate-source charge		-	3	-	nC
Q_{gd}	Gate-drain charge		-	10	-	nC
R_g	Gate input resistance	$f=1\text{ MHz}$, $I_D=0\text{ A}$	-	8	-	Ω

Table 6: Switching energy (inductive load)

Symbol	Parameter	Test conditions	Min.	Typ.	Max.	Unit
E_{on}	Turn-on switching energy	$V_{DD} = 800\text{ V}$, $I_D = 6\text{ A}$ $R_G = 10\text{ }\Omega$, $V_{GS} = -5\text{ to }20\text{ V}$	-	90	-	μJ
E_{off}	Turn-off switching energy		-	30	-	μJ
E_{on}	Turn-on switching energy	$V_{DD} = 800\text{ V}$, $I_D = 6\text{ A}$ $R_G = 10\text{ }\Omega$, $V_{GS} = -5\text{ to }20\text{ V}$ $T_J = 150\text{ °C}$	-	104	-	μJ
E_{off}	Turn-off switching energy		-	33	-	μJ

Table 7: Switching times

Symbol	Parameter	Test conditions	Min.	Typ.	Max.	Unit
$t_{d(on)}$	Turn-on delay time	$V_{DD} = 800 \text{ V}$, $I_D = 6 \text{ A}$, $R_G = 10 \Omega$, $V_{GS} = -5 \text{ to } 20 \text{ V}$	-	7	-	ns
t_f	Fall time		-	17	-	ns
$t_{d(off)}$	Turn-off delay time		-	14	-	ns
t_r	Rise time		-	12	-	ns

Table 8: Reverse SiC diode characteristics

Symbol	Parameter	Test conditions	Min	Typ.	Max	Unit
V_{SD}	Diode forward voltage	$I_F = 6 \text{ A}$, $V_{GS} = 0 \text{ V}$	-	4.3	-	V
t_{rr}	Reverse recovery time	$I_{SD} = 6 \text{ A}$, $di/dt = 2000 \text{ A}/\mu\text{s}$ $V_{DD} = 800 \text{ V}$, $T_J = 150 \text{ }^\circ\text{C}$	-	16	-	ns
Q_{rr}	Reverse recovery charge		-	107	-	nC
I_{RRM}	Reverse recovery current		-	12	-	A

2.2 Electrical characteristics (curves)

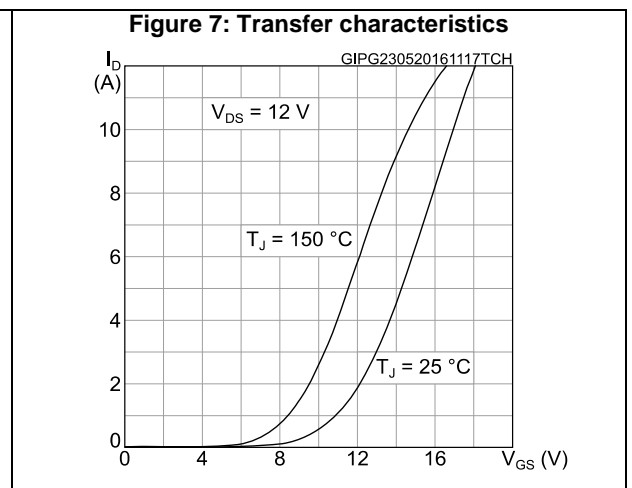
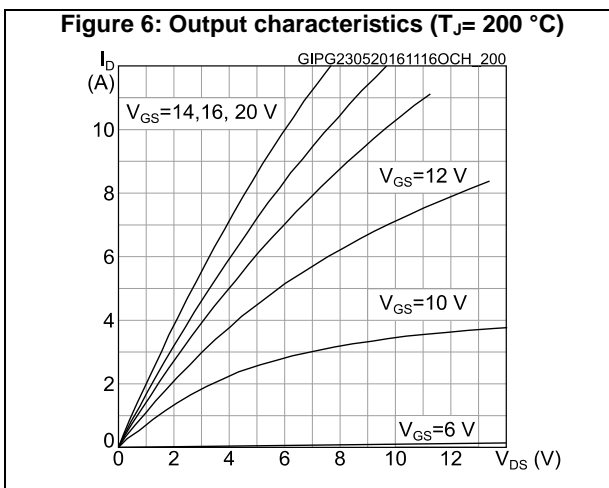
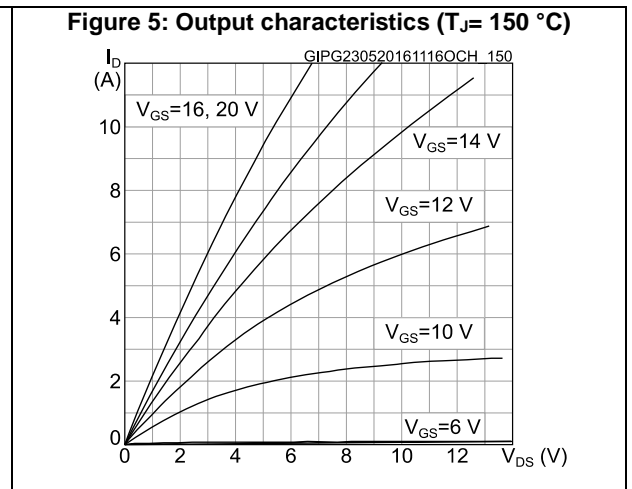
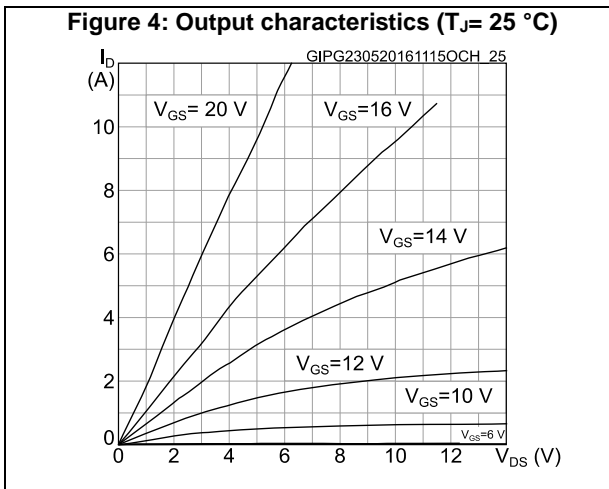
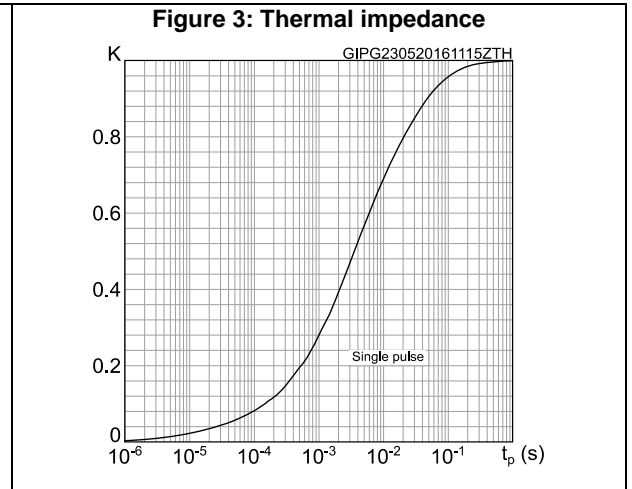
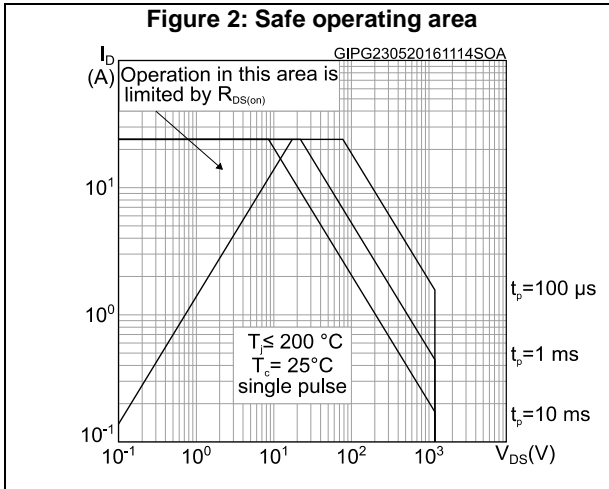

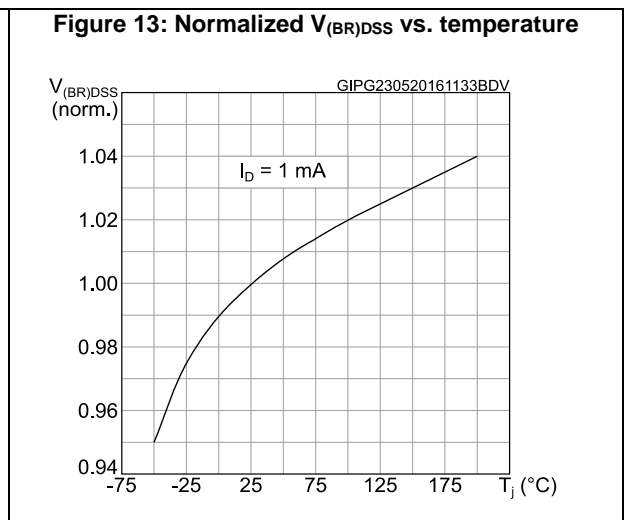
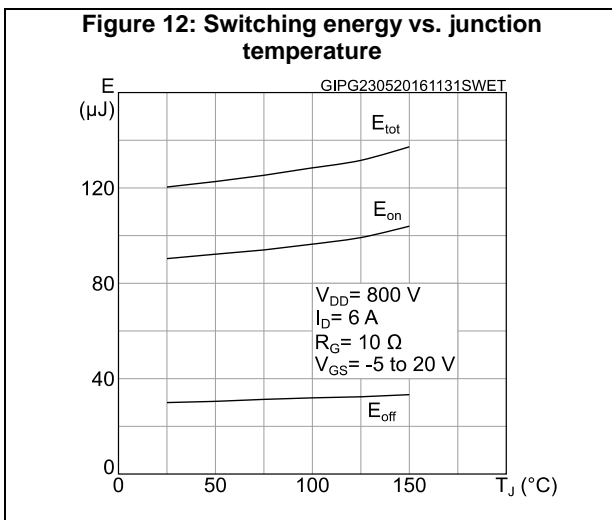
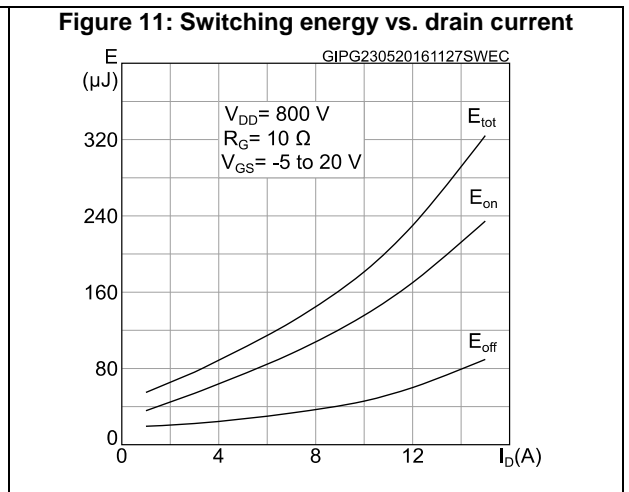
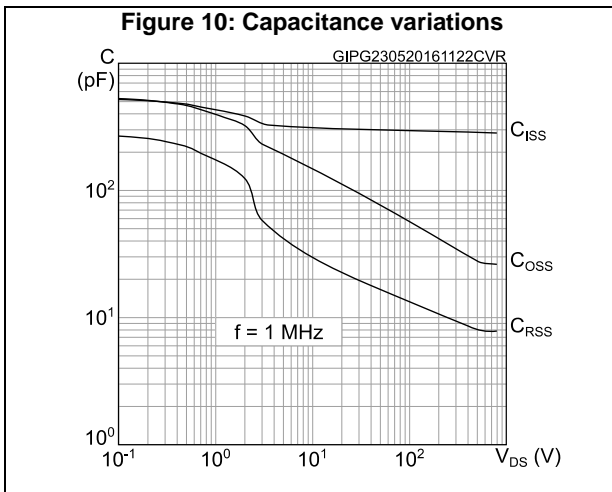
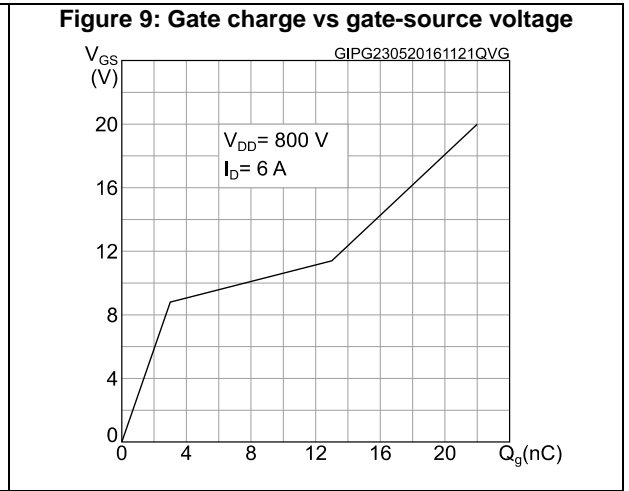
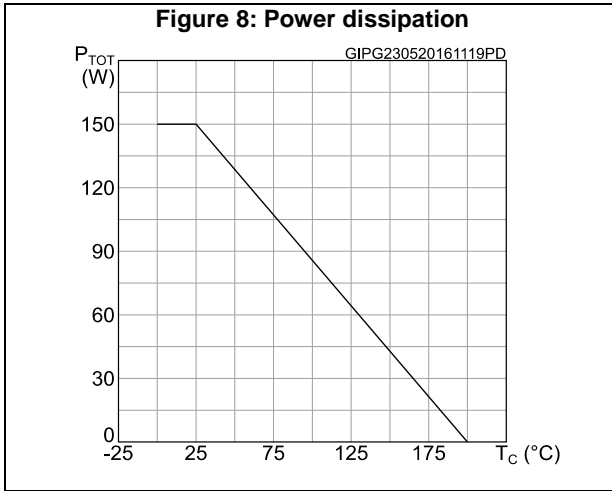

Figure 14: Normalized gate threshold voltage vs. temperature

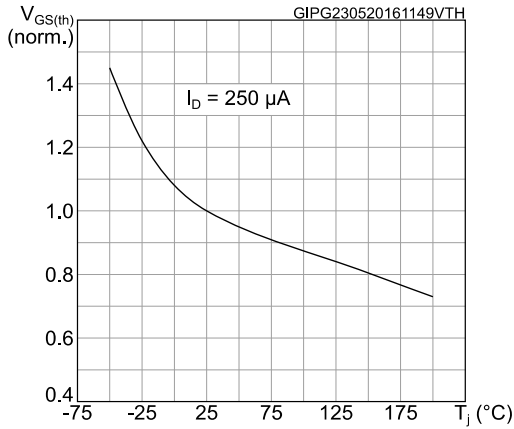

Figure 15: Normalized on-resistance vs. temperature

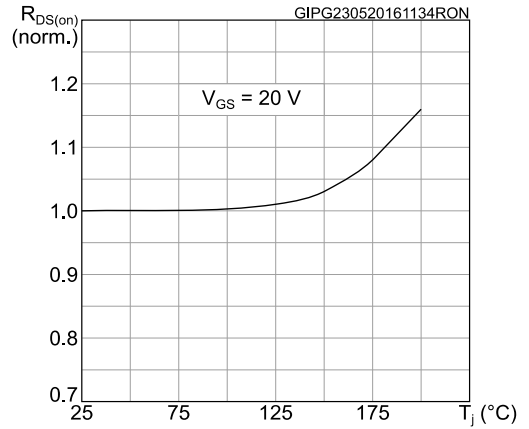

Figure 16: Body diode characteristics ($T_J = -50^\circ C$)

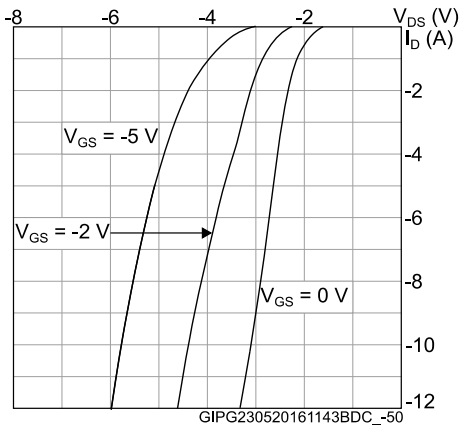

Figure 17: Body diode characteristics ($T_J = 25^\circ C$)

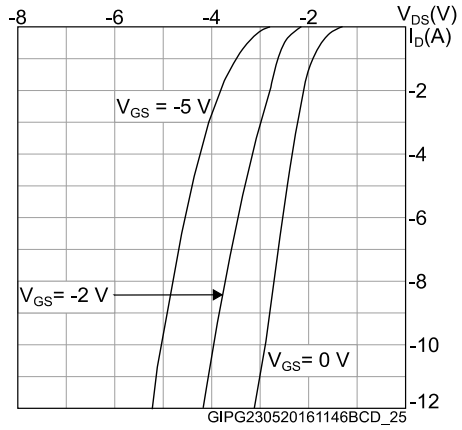

Figure 18: Body diode characteristics ($T_J = 150^\circ C$)

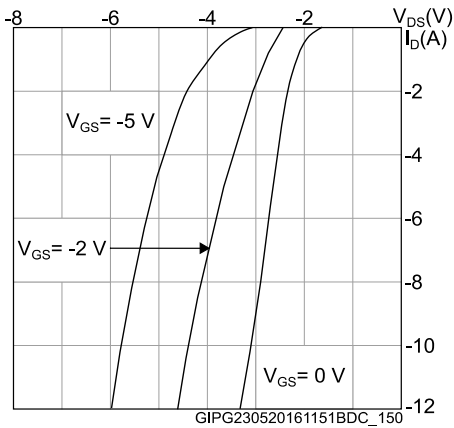
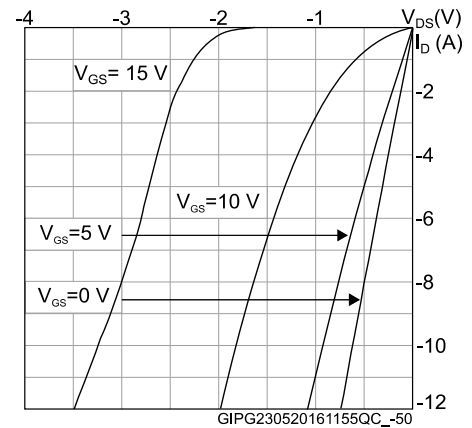
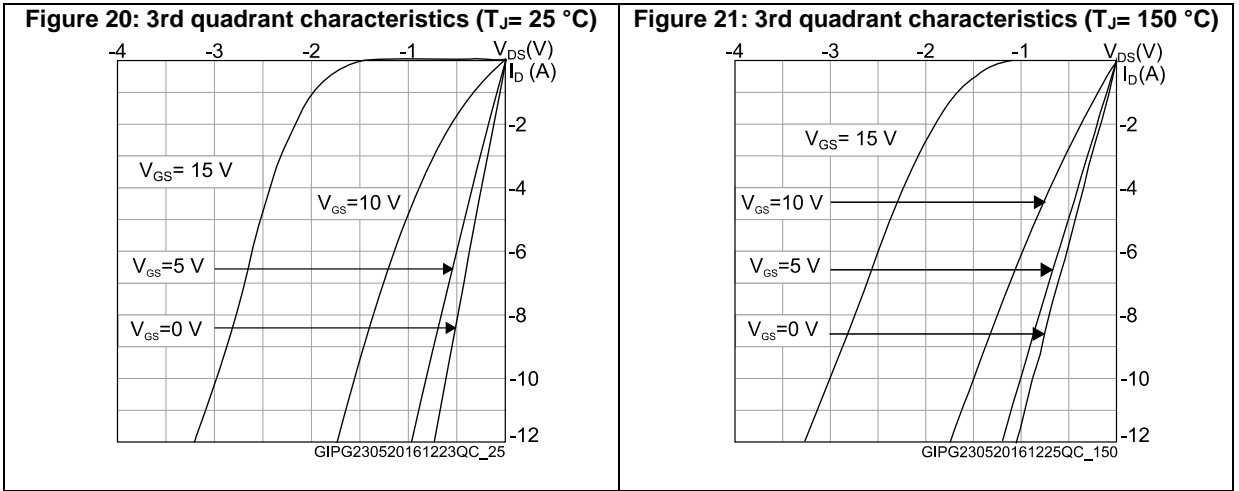

Figure 19: 3rd quadrant characteristics ($T_J = -50^\circ C$)





3 Test circuits

Figure 22: Switching test waveforms for transition times

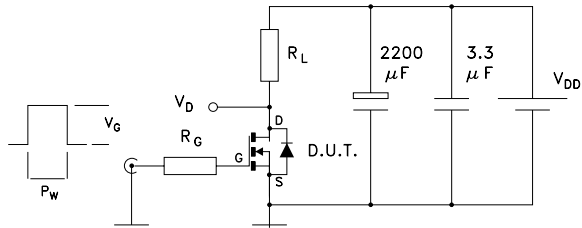

GIPD101020141511FSR

Figure 23: Clamped inductive switching waveform

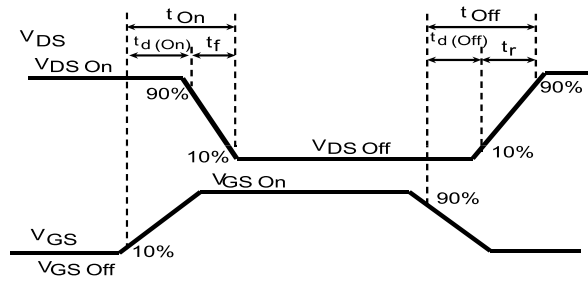

GIPD101020141502FSR

4 Package information

In order to meet environmental requirements, ST offers these devices in different grades of ECOPACK® packages, depending on their level of environmental compliance. ECOPACK® specifications, grade definitions and product status are available at: www.st.com. ECOPACK® is an ST trademark.

4.1 HiP247™ package information

Figure 24: HiP247™ package outline

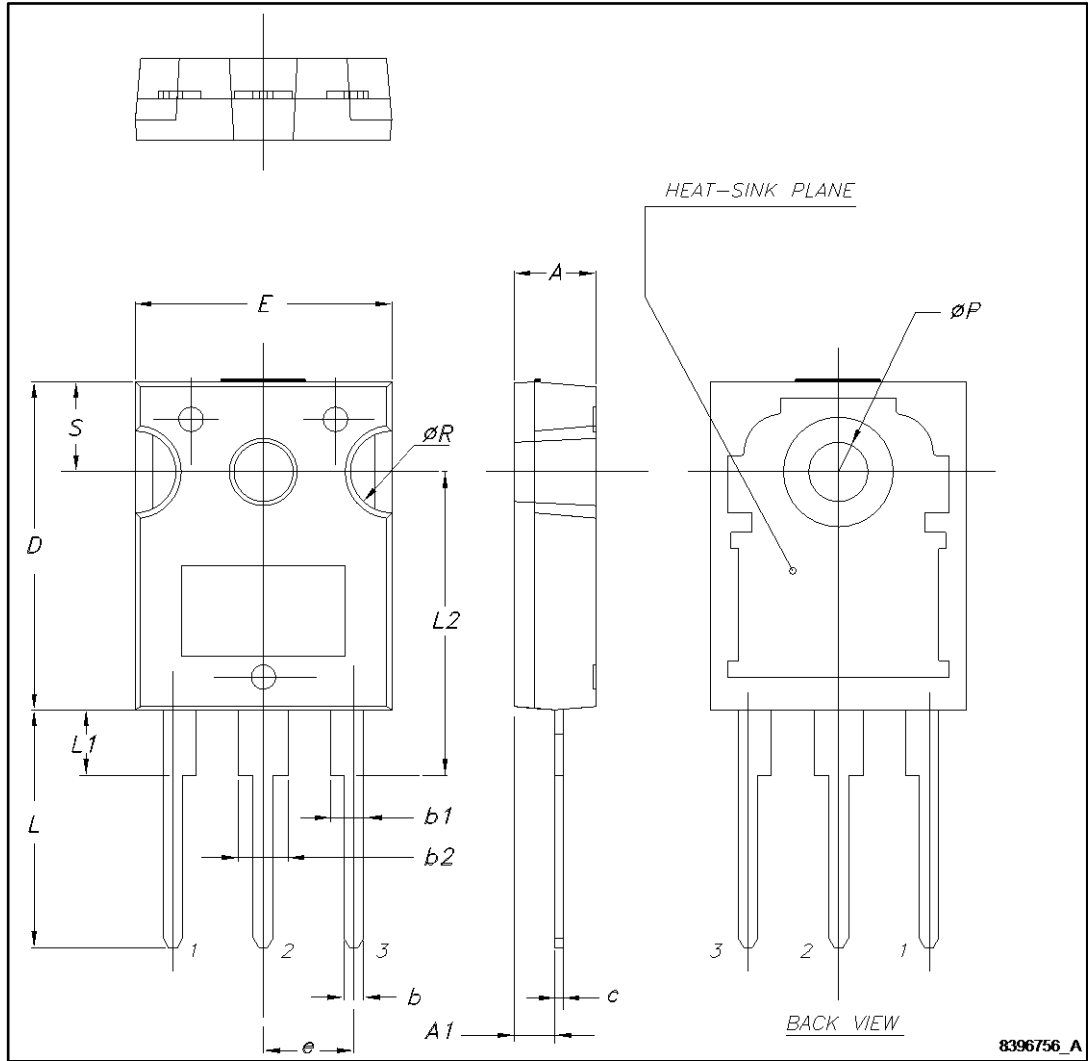

Table 9: HiP247™ package mechanical data

Dim.	mm.		
	Min.	Typ.	Max.
A	4.85		5.15
A1	2.20		2.60
b	1.0		1.40
b1	2.0		2.40
b2	3.0		3.40
c	0.40		0.80
D	19.85		20.15
E	15.45		15.75
e	5.30	5.45	5.60
L	14.20		14.80
L1	3.70		4.30
L2		18.50	
ØP	3.55		3.65
ØR	4.50		5.50
S	5.30	5.50	5.70

5 Revision history

Table 10: Document revision history

Date	Revision	Changes
23-Feb-2016	1	First release
23-May-2016	2	Modified: title, features and <i>Figure 1: "Internal schematic diagram"</i> in cover page Modified: <i>Table 2: "Absolute maximum ratings"</i> and <i>Table 3: "Thermal data"</i> Modified: <i>Table 4: "On/off states"</i> , <i>Table 5: "Dynamic"</i> , <i>Table 6: "Switching energy (inductive load)"</i> , <i>Table 7: "Switching times"</i> and <i>Table 8: "Reverse SiC diode characteristics"</i> Added: <i>Section 4.1: "Electrical characteristics (curves)"</i> Minor text changes

IMPORTANT NOTICE – PLEASE READ CAREFULLY

STMicroelectronics NV and its subsidiaries ("ST") reserve the right to make changes, corrections, enhancements, modifications, and improvements to ST products and/or to this document at any time without notice. Purchasers should obtain the latest relevant information on ST products before placing orders. ST products are sold pursuant to ST's terms and conditions of sale in place at the time of order acknowledgement.

Purchasers are solely responsible for the choice, selection, and use of ST products and ST assumes no liability for application assistance or the design of Purchasers' products.

No license, express or implied, to any intellectual property right is granted by ST herein.

Resale of ST products with provisions different from the information set forth herein shall void any warranty granted by ST for such product.

ST and the ST logo are trademarks of ST. All other product or service names are the property of their respective owners.

Information in this document supersedes and replaces information previously supplied in any prior versions of this document.

© 2016 STMicroelectronics – All rights reserved