

ASSP for Power Management Applications

2 ch DC/DC Converter IC Built-in Switching FET & voltage detection function, PFM/PWM Synchronous Rectification, and Down Conversion Support

MB39C007

■ DESCRIPTION

The MB39C007 is a current mode type 2-channel DC/DC converter IC built-in voltage detection, synchronous rectifier, and down conversion support. The device is integrated with a switching FET, oscillator, error amplifier, PFM/PWM control circuit, reference voltage source, and voltage detection circuit.

External inductor and decoupling capacitor are needed only for the external component.

MB39C007 is small, achieve a highly effective DC/DC converter in the full load range, this is suitable as the built-in power supply for handheld equipment such as mobile phone/PDA, DVDs, and HDDs.

■ FEATURES

- High efficiency : 96% (Max)
- Low current consumption : 30 μ A (At PFM/ch)
- Output current : 800 mA/ch (Max)
- Input voltage range : 2.5 V to 5.5 V
- Operating frequency : 2.0 MHz (Typ)
- Built-in PWM operation fixed function
- No flyback diode needed
- Low dropout operation : For 100% on duty
- Built-in high-precision reference voltage generator : 1.30 V \pm 2%
- Consumption current in shutdown mode : 1 μ A or less
- Built-in switching FET : P-ch MOS 0.3 Ω (Typ) , N-ch MOS 0.2 Ω (Typ)
- High speed for input and load transient response in the current mode
- Over temperature protection
- Packaged in a compact package : QFN-24

■ APPLICATIONS

- Flash ROMs
- MP3 players
- Electronic dictionary devices
- Surveillance cameras
- Portable GPS navigators
- DVD drives
- IP phones
- Network hubs
- Mobile phones etc.

■ PIN ASSIGNMENT

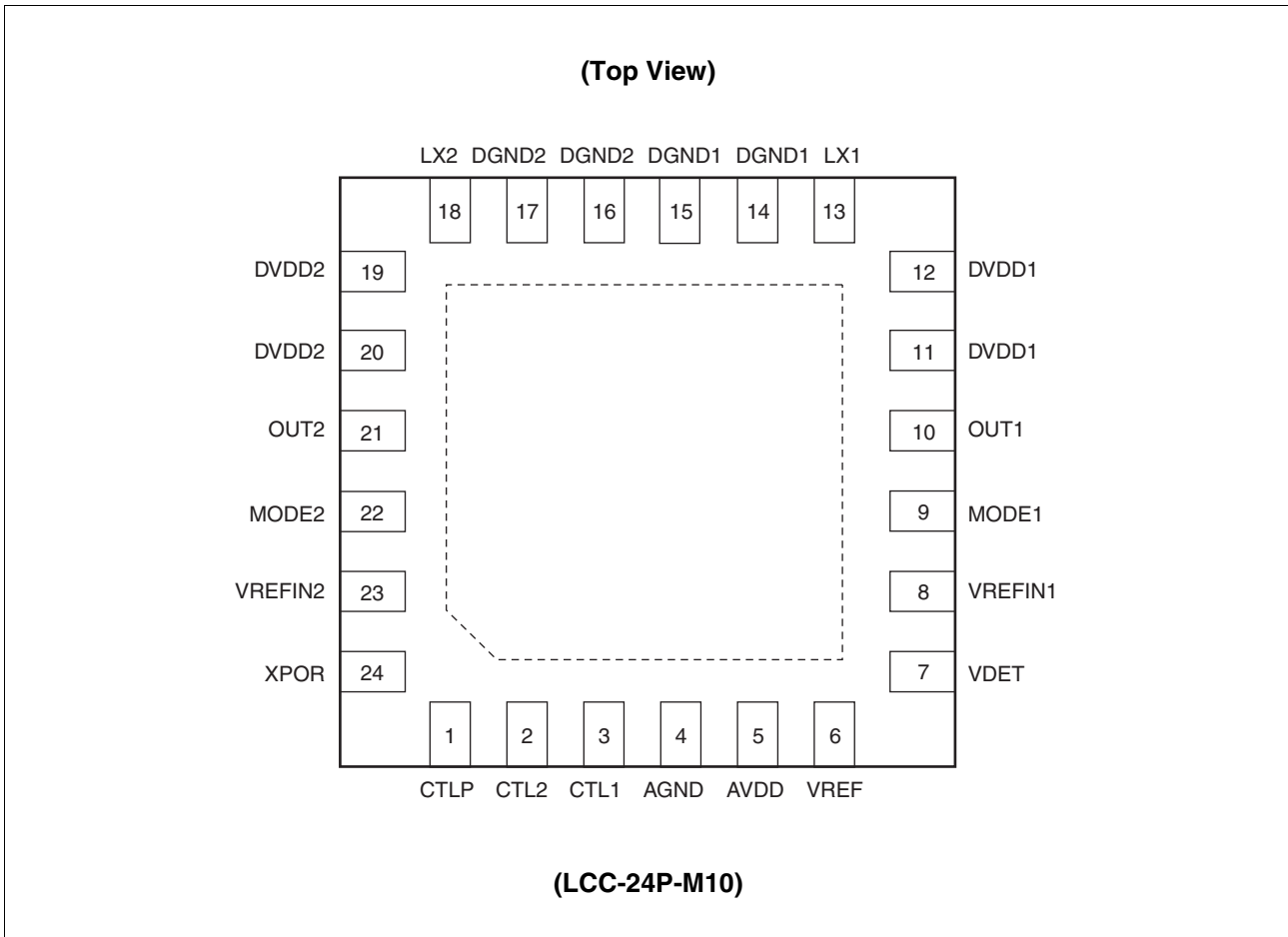

■ PIN DESCRIPTIONS

Pin No.	Pin Name	I/O	Description
1	CTLP	I	Voltage detection circuit block control input pin. (L : Voltage detection function stop , H : Normal operation)
2, 3	CTL2, CTL1	I	DC/DC converter block control input pins. (L : Shut down , H : Normal operation)
4	AGND	—	Control block ground pin.
5	AVDD	—	Control block power supply pin.
6	VREF	O	Reference voltage output pin.
7	VDET	I	Voltage detection input pin.
8, 23	VREFIN1, VREFIN2	I	Error amplifier (Error Amp) non-inverted input pins.
9, 22	MODE1, MODE2	I	Operation mode switch pins. (L : PFM/PWM mode , OPEN : PWM mode)
10, 21	OUT1, OUT2	I	Output voltage feedback pins.
11, 12	DVDD1	—	Drive block power supply pins.
19, 20	DVDD2		
13, 18	LX1, LX2	O	Inductor connection output pins. High impedance during shut down.
14, 15	DGND1	—	Drive block ground pins.
16, 17	DGND2		
24	XPOR	O	VDET circuit output pin. Connected to an N-ch MOS open drain circuit.

I/O PIN EQUIVALENT CIRCUIT DIAGRAM

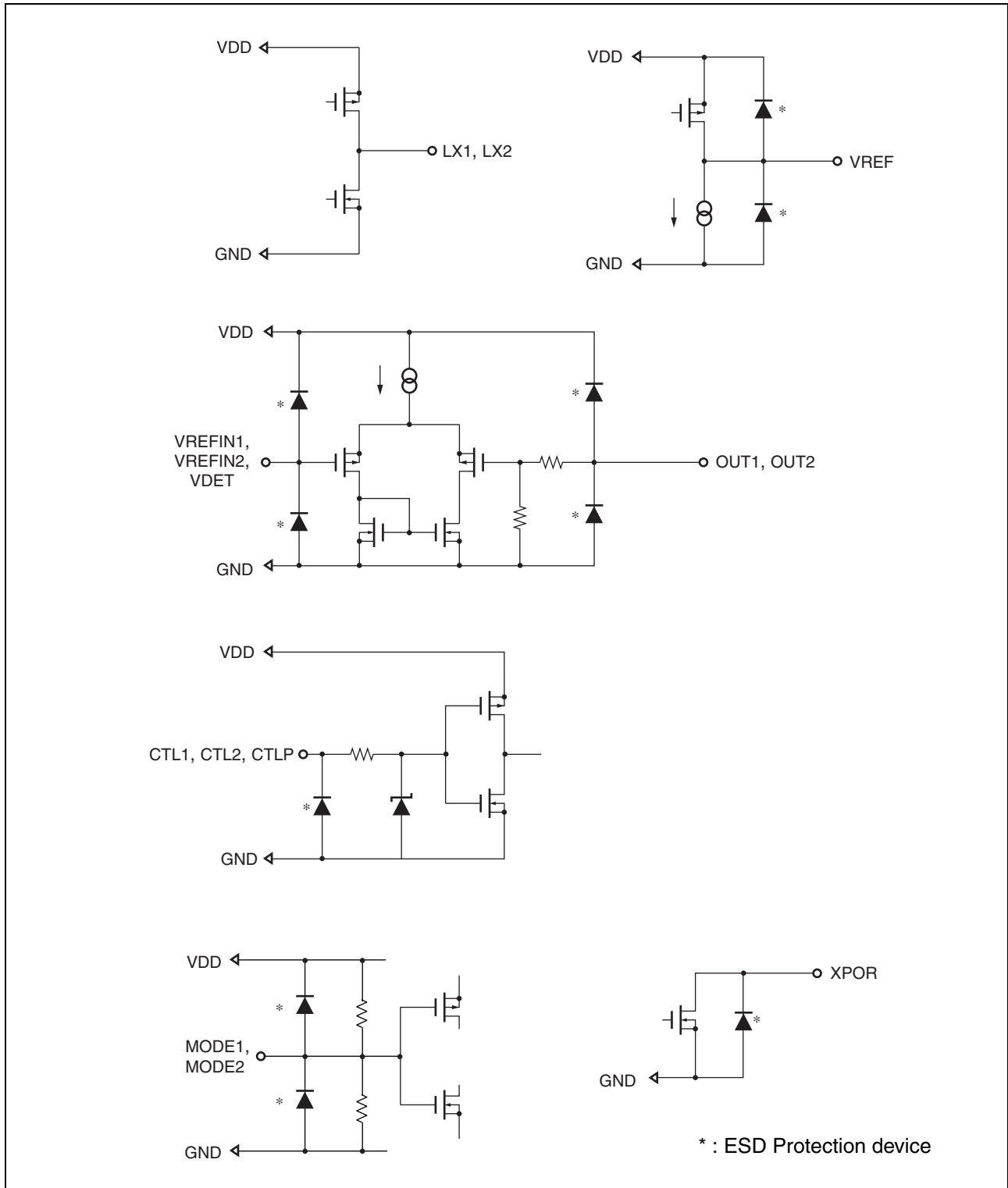

■ BLOCK DIAGRAM

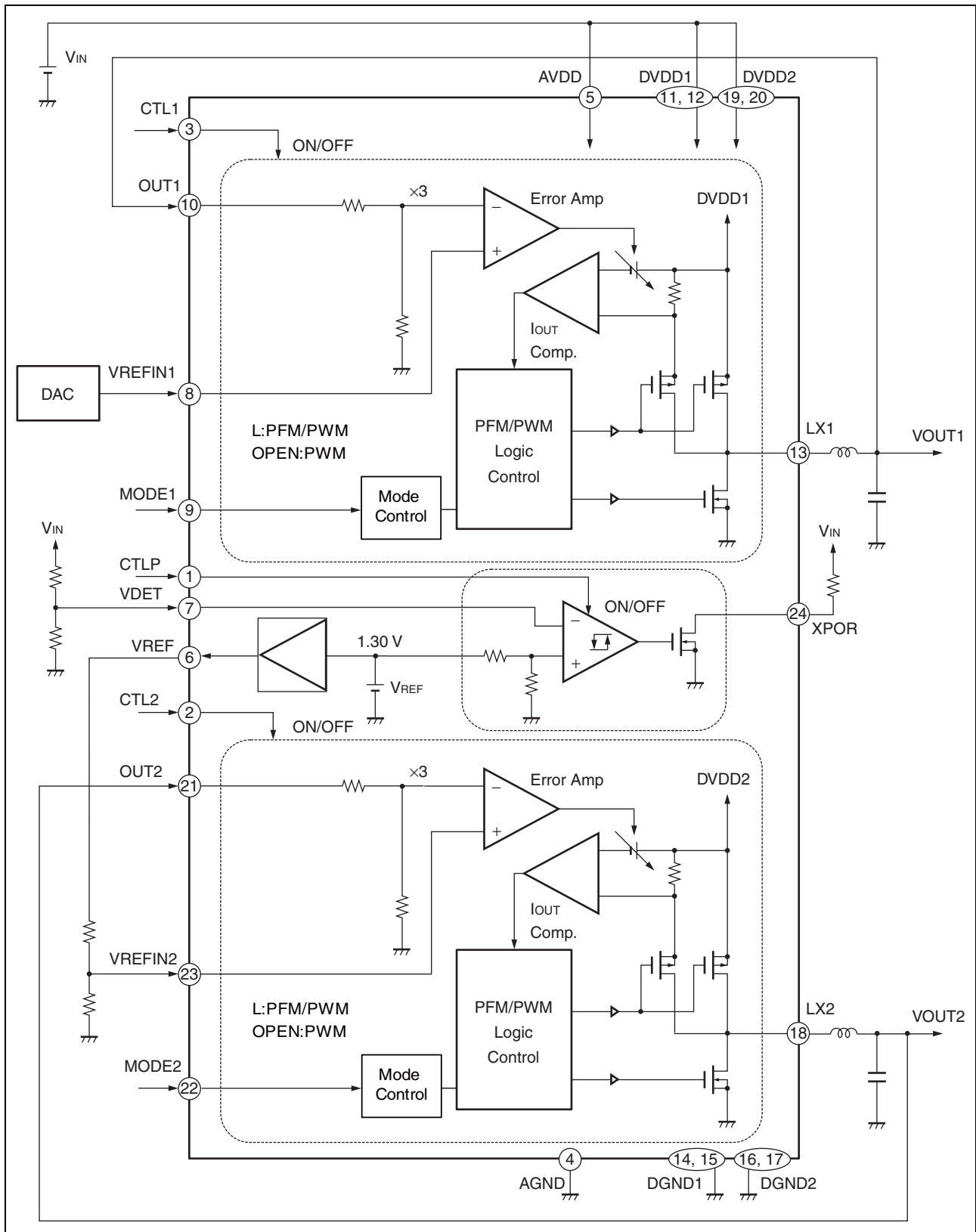

• Current mode

- Original voltage mode type :

Stabilize the output voltage by comparing two items below and on-duty control.

- Voltage (V_C) obtained through negative feedback of the output voltage by Error Amp
- Reference triangular wave (V_{TRI})

- Current mode type :

Instead of the triangular wave (V_{TRI}), the voltage (V_{IDET}) obtained through I-V conversion of the sum of currents that flow in the oscillator (rectangular wave generation circuit) and SW FET is used.

Stabilize the output voltage by comparing two items below and on-duty control.

- Voltage (V_C) obtained through negative feedback of the output voltage by Error Amp
- Voltage (V_{IDET}) obtained through I-V conversion of the sum of current that flow in the oscillator (rectangular wave generation circuit) and SW FET

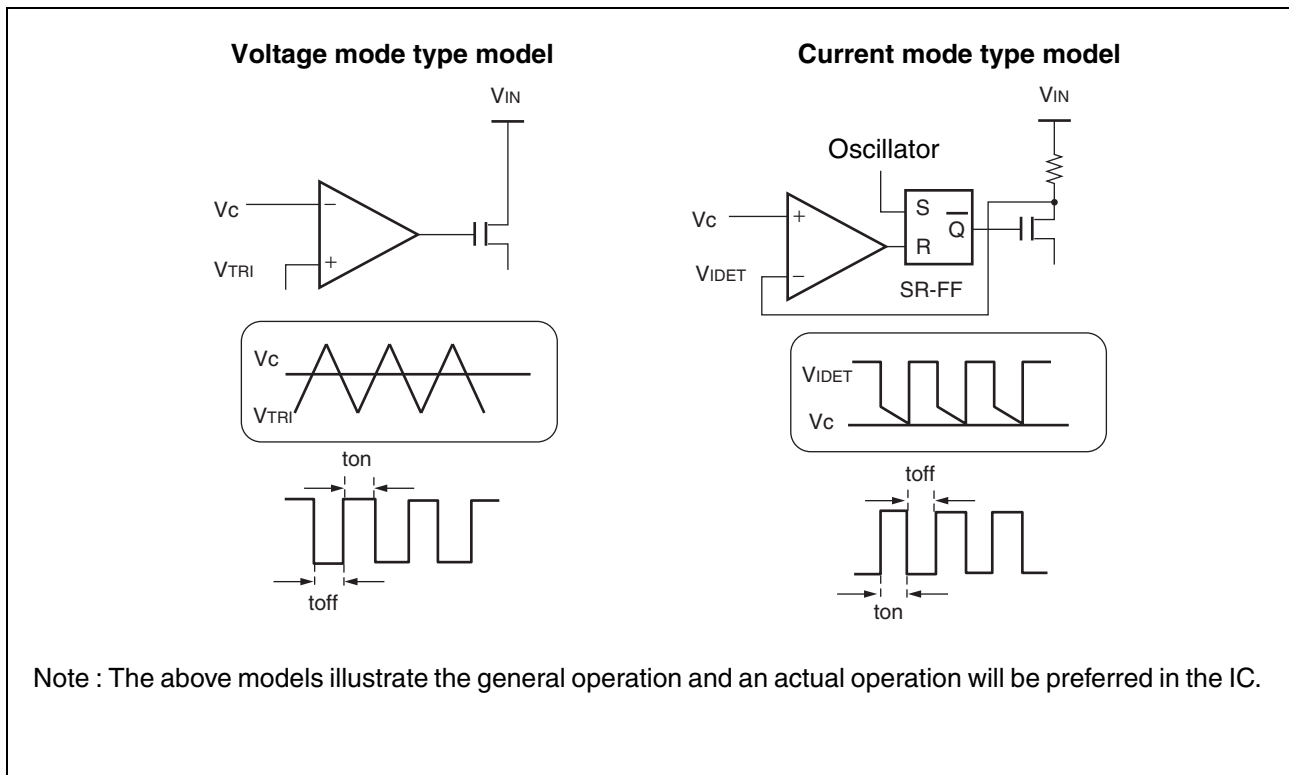

■ FUNCTION OF EACH BLOCK

- PFM/PWM Logic control circuit

In normal operation, frequency (2.0 MHz) which is set by the built-in oscillator (square wave oscillation circuit) controls the built-in P-ch MOS FET and N-ch MOS FET for the synchronous rectification operation. In the light load mode, the intermittent (PFM) operation is executed.

This circuit protects against pass-through current caused by synchronous rectification and against reverse current caused in a non-successive operation mode.

- I_{OUT} Comparator circuit

This circuit detects the current (I_{LX}) which flows to the external inductor from the built-in P-ch MOS FET.

By comparing V_{IDET} obtained through I-V conversion of peak current I_{PK} of I_{LX} with the Error Amp output, the built-in P-ch MOS FET is turned off via the PFM/PWM Logic Control circuit.

- Error Amp phase compensation circuit

This circuit compares the output voltage to reference voltages such as V_{REF} . This IC has a built-in phase compensation circuit that is designed to optimize the operation of this IC.

This needs neither to be considered nor addition of a phase compensation circuit and an external phase compensation device.

- V_{REF} circuit

A high accuracy reference voltage is generated with BGR (bandgap reference) circuit. The output voltage is 1.30 V (Typ).

- Voltage Detection (VDET) circuit

The voltage detection circuit monitors the VDET pin voltage. Normally, use the XPOR pin through pull-up with an external resistor. When the VDET pin voltage reaches 0.6 V, it reaches the H level.

Timing chart example : (XPOR pin pulled up to V_{IN})

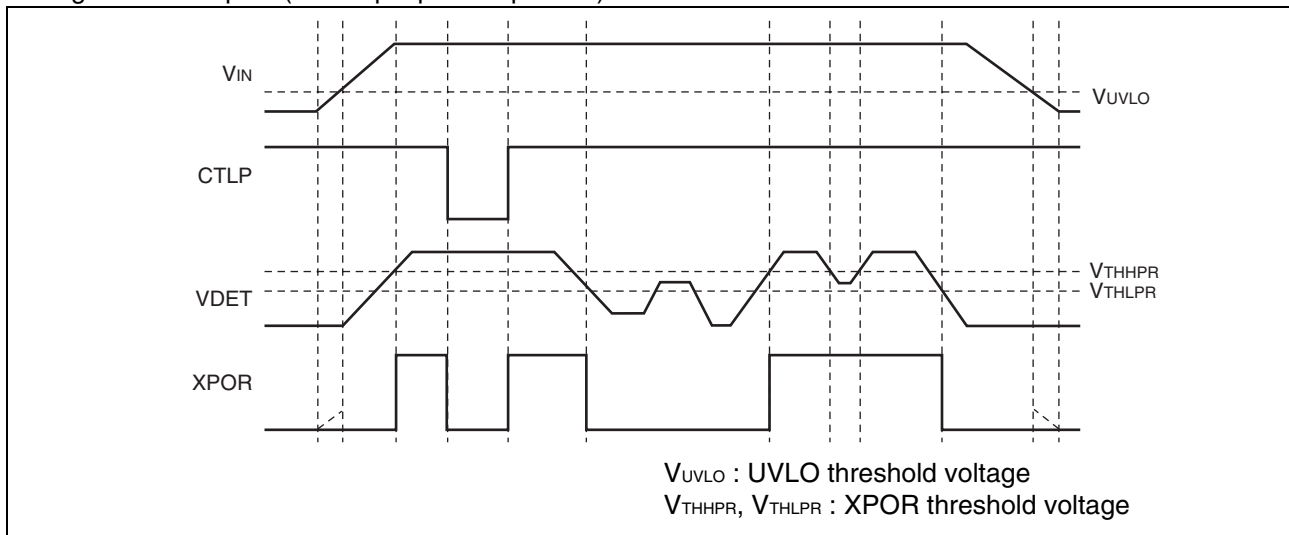

- Protection circuit

This IC has a built-in over-temperature protection circuit.

The over-temperature protection circuit turns off both N-ch and P-ch switching FETs when the junction temperature reaches + 135 °C. When the junction temperature comes down to + 110 °C, the switching FET is returned to the normal operation. Since the PFM/PWM control circuit of this IC is in the control method in current mode, the current peak value is also monitored and controlled as required.

MB39C007

• Function table

Input				Output				
CTL1	CTL2	CTLP	MODE	CH1 function	CH2 function	VDET function	VREF function	Switching operation
L			*	Stopped				
H	L	L	L	Operation	Stopped	Stopped	1.3 V output	PFM/PWM mode
L	H			Stopped	Operation			
H				Operation				
L		Stopped						
H	L	H		Operation	Stopped	Operation		
L	H			Stopped	Operation			
H				Operation				
H	L	L		Open	Operation	Stopped		
L	H		Stopped		Operation			
H			Operation					
L		Stopped						
H	L	H	Operation		Stopped	Operation		
L	H		Stopped		Operation			
H			Operation					

* : Don't care

■ ABSOLUTE MAXIMUM RATINGS

Parameter	Symbol	Condition	Rating		Unit
			Min	Max	
Power supply voltage	V _{DD}	AVDD = DVDD1 = DVDD2	-0.3	+6.0	V
Signal input voltage	V _{SIG}	OUT1, OUT2 pins	-0.3	V _{DD} + 0.3	V
		CTLP, CTL1, CTL2, MODE1, MODE2 pins	-0.3	V _{DD} + 0.3	
		VREFIN1, VREFIN2 pins	-0.3	V _{DD} + 0.3	
		VDET pin	-0.3	V _{DD} + 0.3	
XPOR pull-up voltage	V _{XPOR}	XPOR pin	-0.3	+6.0	V
LX voltage	V _{LX}	LX1, LX2 pins	-0.3	V _{DD} + 0.3	V
LX Peak current	I _{PK}	The upper limit value of I _{LX1} and I _{LX2}	—	1.8	A
Power dissipation	P _D	Ta ≤ +25 °C	—	3125 ^{*1, *2, *3}	mW
			—	1563 ^{*1, *2, *4}	
		Ta = +85 °C	—	1250 ^{*1, *2, *3}	mW
			—	625 ^{*1, *2, *4}	
Operating ambient temperature	T _a	—	-40	+85	°C
Storage temperature	T _{STG}	—	-55	+125	°C

*1 : See the diagram of “■ EXAMPLE OF STANDARD OPERATION CHARACTERISTICS. Power dissipation vs. Operating ambient temperature” for the package power dissipation of Ta from + 25 °C to + 85 °C.

*2 : When mounted on a four-layer epoxy board of 11.7 cm × 8.4 cm

*3 : IC is mounted on a four-layer epoxy board, which has thermal via, and the IC's thermal pad is connected to the epoxy board (Thermal via is 9 holes).

*4 : IC is mounted on a four-layer epoxy board, which has no thermal via, and the IC's thermal pad is connected to the epoxy board.

Notes: • The use of negative voltages below - 0.3 V to the AGND, DGND1, and DGND2 pin may create parasitic transistors on LSI lines, which can cause abnormal operation.

• This device can be damaged if the LX1 pin and LX2 pin are short-circuited to AVDD and DVDD1/DVDD2, or AGND and DGND1/DGND2.

WARNING: Semiconductor devices can be permanently damaged by application of stress (voltage, current, temperature, etc.) in excess of absolute maximum ratings. Do not exceed these ratings.

■ RECOMMENDED OPERATING CONDITIONS

Parameter	Symbol	Condition	Value			Unit
			Min	Typ	Max	
Power supply voltage	V_{DD}	$AVDD = DVDD1 = DVDD2$	2.5	3.7	5.5	V
VREFIN voltage	V_{REFIN}	—	0.15	—	1.30	V
CTL voltage	V_{CTL}	CTLP, CTL1, CTL2 pins	0	—	5.0	V
LX current	I_{LX}	I_{LX1}, I_{LX2}	—	—	800	mA
VREF output current	I_{ROUT}	$2.5\text{ V} \leq AVDD = DVDD1 = DVDD2 < 3.0\text{ V}$	—	—	0.5	mA
		$3.0\text{ V} \leq AVDD = DVDD1 = DVDD2 \leq 5.5\text{ V}$	—	—	1	
XPOR current	I_{POR}	—	—	—	1	mA
Inductor value	L	—	—	2.2	—	μH

Note : The output current from this device has a situation to decrease if the power supply voltage (V_{IN}) and the DC/DC converter output voltage (V_{OUT}) differ only by a small amount. This is a result of slope compensation and will not damage this device.

WARNING: The recommended operating conditions are required in order to ensure the normal operation of the semiconductor device. All of the device's electrical characteristics are warranted when the device is operated within these ranges.

Always use semiconductor devices within their recommended operating condition ranges. Operation outside these ranges may adversely affect reliability and could result in device failure. No warranty is made with respect to uses, operating conditions, or combinations not represented on the data sheet. Users considering application outside the listed conditions are advised to contact their representatives beforehand.

■ ELECTRICAL CHARACTERISTICS

(Ta = +25 °C, AVDD = DVDD1 = DVDD2 = 3.7 V, VOUT1/VOUT2 setting value = 2.5 V, MODE1/MODE2 = 0 V)

Parameter	Symbol	Pin No.	Condition	Value			Unit		
				Min	Typ	Max			
DC/DC converter block	Input current	I _{REFIN}	8, 23	V _{REFIN} = 0.15 V to 1.3 V	- 100	0	+ 100	nA	
	Output voltage	V _{OUT}	10, 21	V _{REFIN} = 0.833 V, OUT = -100 mA	2.45	2.50	2.55	V	
	Input stability	LINE		2.5 V ≤ AVDD = DVDD1 = DVDD2 ≤ 5.5 V* ¹	—	—	10	mV	
	Load stability	LOAD		-100 mA ≥ OUT ≥ -800 mA	—	—	10	mV	
	OUT pin input impedance	R _{OUT}		OUT = 2.0 V	0.6	1.0	1.5	MΩ	
	LX Peak current	I _{PK}	13, 18	Output shorted to GND	0.9	1.2	1.7	A	
	PFM/PWM switch current	I _{MSW}		—	—	30	—	mA	
	Oscillation frequency	f _{osc}		—	1.6	2.0	2.4	MHz	
	Rise delay time	t _{PG}	2, 3, 10, 21	C1/C2 = 4.7 μF, OUT = 0 A, OUT1/OUT2 : 0 → 90% V _{OUT}	—	45	80	μs	
	SW NMOS-FET OFF voltage	V _{NOFF}	13, 18	—	—	- 10*	—	mV	
	SW PMOS-FET ON resistance	R _{ONP}		LX1/LX2 = -100 mA	—	0.30	0.48	Ω	
	SW NMOS-FET ON resistance	R _{ONN}		LX1/LX2 = -100 mA	—	0.20	0.42	Ω	
	LX leak current	I _{LEAKM}		0 ≤ LX ≤ V _{DD} * ²	- 1.0	—	+ 8.0	μA	
I _{LEAKH}		V _{DD} = 5.5 V, 0 ≤ LX ≤ V _{DD} * ²		- 2.0	—	+ 16.0	μA		
Protection circuit block	Overheating protection (Junction Temp.)	T _{OTPH}	—	—	+ 120*	+ 135*	+ 160*	°C	
		T _{OTPL}			+ 95*	+ 110*	+ 125*	°C	
	UVLO threshold voltage	V _{THHUV}	5, 11, 12, 19, 20	—	—	2.17	2.30	2.43	V
		V _{THLUV}				2.03	2.15	2.27	V
UVLO hysteresis width	V _{HYSUV}	—	0.08	0.15	0.25	V			
Voltage detection circuit block	XPOR threshold voltage	V _{THHPR}	7	—	575	600	625	mV	
		V _{THLPR}			558	583	608	mV	
	XPOR hysteresis width	V _{HYSPR}	—	—	17	—	mV		
	XPOR output voltage	V _{OL}	24	XPOR = 25 μA	—	—	0.1	V	
	XPOR output current	I _{OH}		XPOR = 5.5 V	—	—	1.0	μA	

* : This value is not be specified. This should be used as a reference to support designing the circuits.

(Continued)

MB39C007

(Continued)

(Ta = +25 °C, AVDD = DVDD1 = DVDD2 = 3.7 V, VOUT1/VOUT2 setting value = 2.5 V, MODE1/MODE2 = 0 V)

Parameter		Symbol	Pin No.	Condition	Value			Unit
					Min	Typ	Max	
Control block	CTL threshold voltage	V _{THHCT}	1, 2, 3	—	0.55	0.95	1.45	V
		V _{THLCT}		—	0.40	0.80	1.30	V
	CTL pin input current	I _{ICTL}		0 V ≤ CTLP/CTL1/CTL2 ≤ 3.7 V	—	—	1.0	μA
Reference voltage block	VREF voltage	V _{REF}	6	VREF = 0 A	1.274	1.300	1.326	V
	VREF Load stability	LOADREF		VREF = -1.0 mA	—	—	20	mV
General	Shut down power supply current	I _{VDD1}	5, 11, 12, 19, 20	CTLP/CTL1/CTL2 = 0 V, State of all circuits OFF*3	—	—	1.0	μA
		I _{VDD1H}		CTLP/CTL1/CTL2 = 0 V, V _{DD} = 5.5 V, State of all circuits OFF*3	—	—	1.0	μA
	Power supply current at DC/DC operation 1 (PFM mode)	I _{VDD21}		1. CTLP = 0 V, CTL1 = 3.7 V, CTL2 = 0 V 2. CTLP = 0 V, CTL1 = 0 V, CTL2 = 3.7 V, OUT = 0 A	—	30	48	μA
		I _{VDD22}		CTLP = 0 V, CTL1/CTL2 = 3.7 V, OUT = 0 A	—	50	80	μA
	Power supply current at DC/DC operation 2 (PWM mode)	I _{VDD31}		1. CTLP = 0 V, CTL1 = 3.7 V, CTL2 = 0 V, MODE1/MODE2 = OPEN 2. CTLP = 0 V, CTL1 = 0 V, CTL2 = 3.7 V, MODE1/MODE2 = OPEN, OUT = 0 A	—	3.5	10.0	mA
		I _{VDD32}		CTLP = 0 V, CTL1/CTL2 = 3.7 V, MODE1/MODE2 = OPEN, OUT = 0 A	—	7.0	20.0	mA
	Power supply current (voltage detection mode)	I _{VDD5}		CTLP = 3.7 V, CTL1/CTL2 = 0 V	—	15	24	μA
	Power-on invalid current	I _{VDD}		1. CTL1 = 3.7 V, CTL2 = 0 V 2. CTL1 = 0 V, CTL2 = 3.7 V, VOUT1/VOUT2 = 90%, OUT = 0 A*4	—	1000	2000	μA

*1 : The minimum value of AVDD = DVDD1 = DVDD2 is the 2.5 V or V_{OUT} setting value + 0.6 V, whichever is higher.

*2 : The + leak at the LX1 pin and LX2 pin includes the current of the internal circuit.

*3 : Sum of the current flowing into the AVDD, the DVDD1, and the DVDD2 pins.

*4 : Current consumption based on 100% ON-duty (High side FET in full ON state). The SW FET gate drive current is not included because the device is in full ON state (no switching operation). Also the load current is not included.

TEST CIRCUIT FOR MEASURING TYPICAL OPERATING CHARACTERISTICS

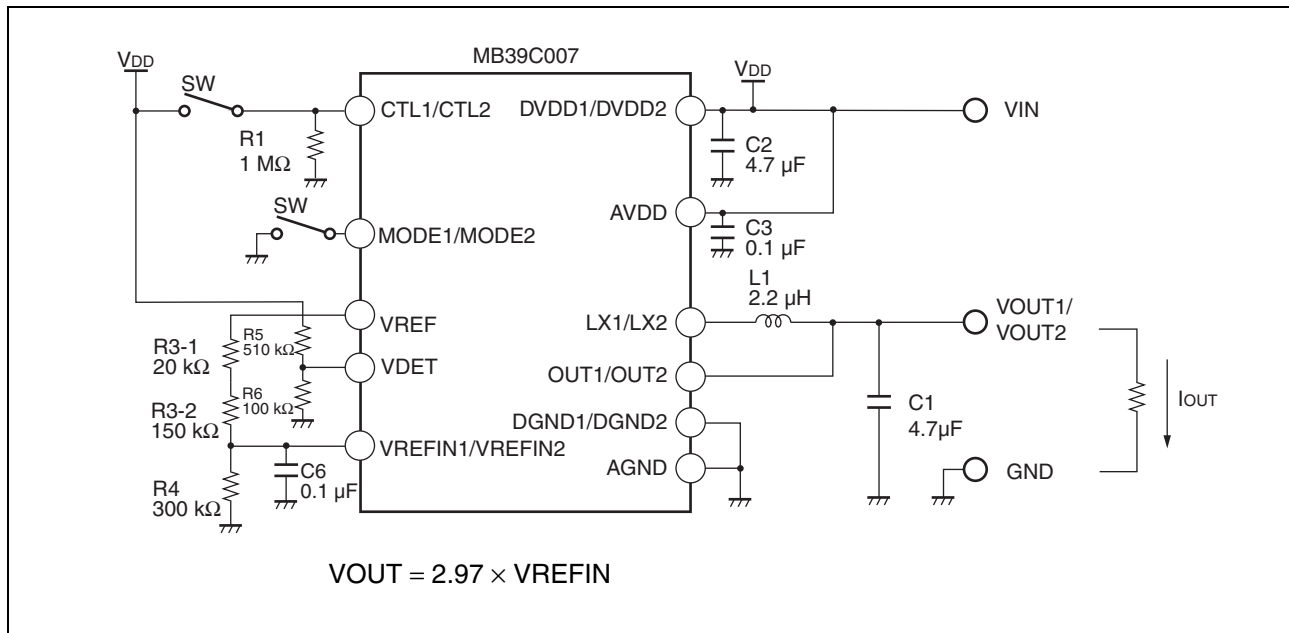

Component	Specification	Vendor	Part Number	Remarks
R1	1 MΩ	KOA	RK73G1JTDD D 1 MΩ	
R3-1	20 kΩ	SSM	RR0816-203-D	VOUT1/VOUT2 = 2.5 V Setting
R3-2	150 kΩ	SSM	RR0816-154-D	
R4	300 kΩ	SSM	RR0816-304-D	
R5	510 kΩ	KOA	RK73G1JTDD D 510 kΩ	
R6	100 kΩ	SSM	RR0816-104-D	
C1	4.7 μF	TDK	C2012JB1A475K	
C2	4.7 μF	TDK	C2012JB1A475K	
C3	0.1 μF	TDK	C1608JB1E104K	
C6	0.1 μF	TDK	C1608JB1H104K	For adjusting slow start time
L1	2.2 μH	TDK	VLF4012AT-2R2M	

Note : These components are recommended based on the operating tests authorized.

TDK : TDK Corporation

SSM : SUSUMU Co., Ltd

KOA : KOA Corporation

■ APPLICATION NOTES

[1] Selection of components

• Selection of an external inductor

Basically it does not need to design inductor. This IC is designed to operate efficiently with a 2.2 μH external inductor.

The inductor should be rated for a saturation current higher than the LX peak current value during normal operating conditions, and should have a minimal DC resistance. (100 mΩ or less is recommended.)

LX peak current value I_{PK} is obtained by the following formula.

$$I_{PK} = I_{OUT} + \frac{V_{IN} - V_{OUT}}{L} \times \frac{D}{f_{osc}} \times \frac{1}{2} = I_{OUT} + \frac{(V_{IN} - V_{OUT}) \times V_{OUT}}{2 \times L \times f_{osc} \times V_{IN}}$$

- L : External inductor value
- I_{OUT} : Load current
- V_{IN} : Power supply voltage
- V_{OUT} : Output setting voltage
- D : ON-duty to be switched (= V_{OUT}/V_{IN})
- f_{osc} : Switching frequency (2.0 MHz)

ex) When $V_{IN} = 3.7$ V, $V_{OUT} = 2.5$ V, $I_{OUT} = 0.8$ A, $L = 2.2$ μH, $f_{osc} = 2.0$ MHz
The maximum peak current value I_{PK} is obtained by the following formula.

$$I_{PK} = I_{OUT} + \frac{(V_{IN} - V_{OUT}) \times V_{OUT}}{2 \times L \times f_{osc} \times V_{IN}} = 0.8 \text{ A} + \frac{(3.7 \text{ V} - 2.5 \text{ V}) \times 2.5 \text{ V}}{2 \times 2.2 \text{ μH} \times 2.0 \text{ MHz} \times 3.7 \text{ V}} \approx 0.89 \text{ A}$$

• I/O capacitor selection

- Select a low equivalent series resistance (ESR) for the VDD input capacitor to suppress dissipation from ripple currents.
- Also select a low equivalent series resistance (ESR) for the output capacitor. The variation in the inductor current causes ripple currents on the output capacitor which, in turn, causes ripple voltages an output equal to the amount of variation multiplied by the ESR value. The output capacitor value has a significant impact on the operating stability of the device when used as a DC/DC converter. Therefore, FUJITSU SEMICONDUCTOR generally recommends a 4.7 μF capacitor, or a larger capacitor value can be used if ripple voltages are not suitable. If the V_{IN}/V_{OUT} voltage difference is within 0.6 V, the use of a 10 μF output capacitor value is recommended.
- Types of capacitors
Ceramic capacitors are effective for reducing the ESR and afford smaller DC/DC converter circuit. However, power supply functions as a heat generator, therefore avoid to use capacitor with the F-temperature rating (−80% to +20%). FUJITSU SEMICONDUCTOR recommends capacitors with the B-temperature rating (±10% to ±20%).
Normal electrolytic capacitors are not recommended due to their high ESR.
Tantalum capacitor will reduce ESR, however, it is dangerous to use because it turns into short mode when damaged. If you insist on using a tantalum capacitor, FUJITSU SEMICONDUCTOR recommends the type with an internal fuse.

[2] Output voltage setting

The output voltage V_{OUT} (V_{OUT1} or V_{OUT2}) of this IC is defined by the voltage input to VREFIN (VREFIN1 or VREFIN2) . Supply the voltage for inputting to VREFIN from an external power supply, or set the VREF output by dividing it with resistors.

The output voltage when the VREFIN voltage is set by dividing the VREF voltage with resistors is obtained by the following formula.

$$V_{OUT} = 2.97 \times V_{REFIN}, \quad V_{REFIN} = \frac{R2}{R1 + R2} \times V_{REF}$$

$$(V_{REF} = 1.30 \text{ V})$$

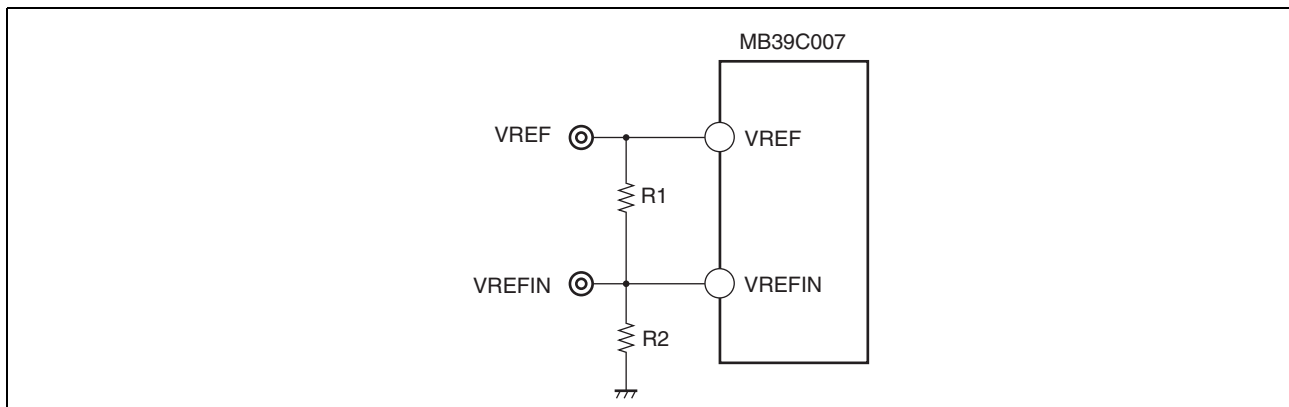

Note : Refer to “■ APPLICATION CIRCUIT EXAMPLES” for the an example of this circuit.

Although the output voltage is defined according to the dividing ratio of resistance, select the resistance value so that the current flowing through the resistance does not exceed the VREF current rating (1 mA) .

[3] About conversion efficiency

The conversion efficiency can be improved by reducing the loss of the DC/DC converter circuit. The total loss (P_{LOSS}) of the DC/DC converter is roughly divided as follows :

$$P_{LOSS} = P_{CONT} + P_{SW} + P_C$$

P_{CONT} : Control system circuit loss (The power used for this IC to operate, including the gate driving power for internal SW FETs)

P_{SW} : Switching loss (The loss caused during switching of the IC's internal SW FETs)

P_C : Continuity loss (The loss caused when currents flow through the IC's internal SW FETs and external circuits)

The IC's control circuit loss (P_{CONT}) is extremely small, less than 100 mW* (with no load).

As the IC contains FETs which can switch faster with less power, the continuity loss (P_C) is more predominant as the loss during heavy-load operation than the control circuit loss (P_{CONT}) and switching loss (P_{SW}) .

Furthermore, the continuity loss (P_C) is divided roughly into the loss by internal SW FET ON-resistance and by external inductor series resistance.

$$P_C = I_{OUT}^2 \times (RDC + D \times R_{ONP} + (1 - D) \times R_{ONN})$$

D : Switching ON-duty cycle (= V_{OUT} / V_{IN})

R_{ONP} : Internal P-ch SW FET ON resistance

R_{ONN} : Internal N-ch SW FET ON resistance

RDC : External inductor series resistance

I_{OUT} : Load current

The above formula indicates that it is important to reduce RDC as much as possible to improve efficiency by selecting components.

* : The loss in the successive operation mode. This IC suppresses the loss in order to execute the PFM operation in the low load mode (less than 100 μ A in no load mode). Mode is changed by the current peak value I_{PK} which flows into switching FET. The threshold value is about 30 mA.

[4] Power dissipation and heat considerations

The IC is so efficient that no consideration is required in most cases. However, if the IC is used at a low power supply voltage, heavy load, high output voltage, or high temperature, it requires further consideration for higher efficiency.

The internal loss (P) is roughly obtained from the following formula:

$$P = I_{OUT}^2 \times (D \times R_{ONP} + (1 - D) \times R_{ONN})$$

D : Switching ON-duty cycle (= V_{OUT} / V_{IN})

R_{ONP} : Internal P-ch SW FET ON resistance

R_{ONN} : Internal N-ch SW FET ON resistance

I_{OUT} : Output current

The loss expressed by the above formula is mainly continuity loss. The internal loss includes the switching loss and the control circuit loss as well but they are so small compared to the continuity loss they can be ignored.

In this IC with R_{ONP} greater than R_{ONN}, the larger the on-duty cycle, the greater the loss.

When assuming V_{IN} = 3.7 V, Ta = + 70 °C, for example, R_{ONP} = 0.36 Ω and R_{ONN} = 0.30 Ω according to the graph "MOS FET ON resistance vs. Operating ambient temperature". The IC's internal loss P is 123 mW at V_{OUT} = 2.5 V and I_{OUT} = 0.6 A. According to the graph "Power dissipation vs. Operating ambient temperature", the power dissipation at an operating ambient temperature Ta of + 70 °C is 300 mW and the internal loss is smaller than the power dissipation.

[5] XPOR threshold voltage setting [V_{PORH}, V_{PORL}]

Set the detection voltage by applying voltage to the VDET pin via an external resistor calculated according to this formula.

$$V_{PORH} = \frac{R3 + R4}{R4} \times V_{THHPR}$$

$$V_{PORL} = \frac{R3 + R4}{R4} \times V_{THLPR}$$

$$V_{THHPR} = 0.600 \text{ V}$$

$$V_{THLPR} = 0.583 \text{ V}$$

- Example for setting detection voltage to 3.7 V

$$R3 = 510 \text{ k}\Omega$$

$$R4 = 100 \text{ k}\Omega$$

$$V_{PORH} = \frac{510 \text{ k}\Omega + 100 \text{ k}\Omega}{100 \text{ k}\Omega} \times 0.600 = 3.66 \approx 3.7 \text{ [V]}$$

$$V_{PORL} = \frac{510 \text{ k}\Omega + 100 \text{ k}\Omega}{100 \text{ k}\Omega} \times 0.583 = 3.56 \approx 3.6 \text{ [V]}$$

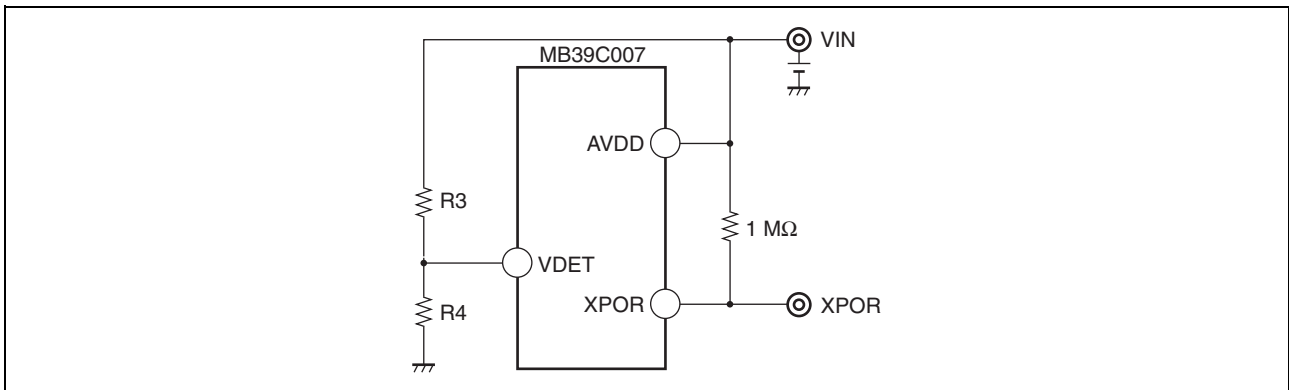

[6] Transient response

Normally, I_{OUT} is suddenly changed while V_{IN} and V_{OUT} are maintained constant, responsiveness including the response time and overshoot/undershoot voltage is checked. As this IC has built-in Error Amp with an optimized design, it shows good transient response characteristics. However, if ringing upon sudden change of the load is high due to the operating conditions, add capacitor C6 (e.g. 0.1 μ F). (Since this capacitor C6 changes the start time, check the start waveform as well.) This action is not required for DAC input.

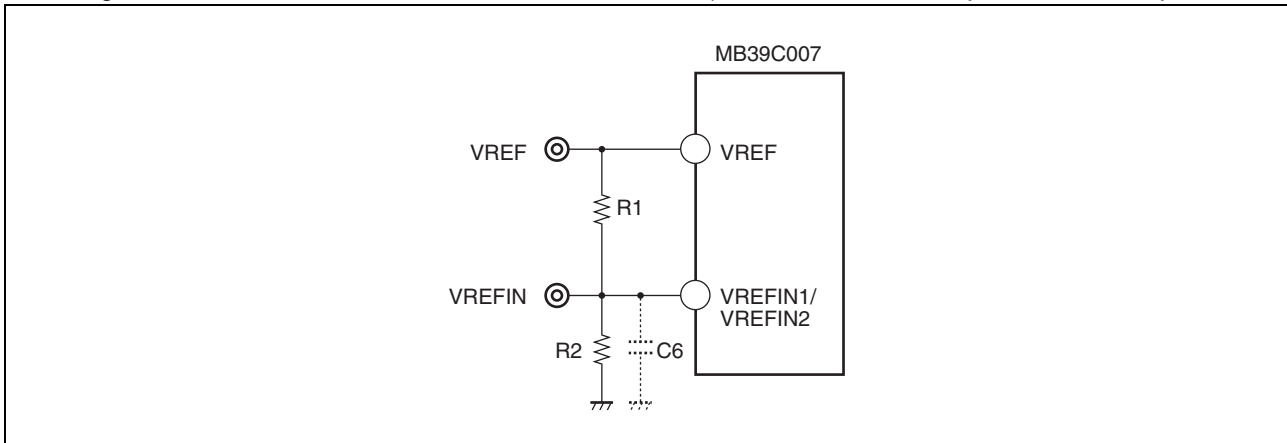

[7] Board layout, design example

The board layout needs to be designed to ensure the stable operation of this IC. Follow the procedure below for designing the layout.

- Arrange the input capacitor (Cin) as close as possible to both the VDD and GND pins. Make a through-hole (TH) near the pins of this capacitor if the board has planes for power and GND.
- Large AC currents flow between this IC and the input capacitor (Cin), output capacitor (Co), and external inductor (L). Group these components as close as possible to this IC to reduce the overall loop area occupied by this group. Also try to mount these components on the same surface and arrange wiring without through-hole wiring. Use thick, short, and straight routes to wire the net (The layout by planes is recommended.).
- Arrange a bypass capacitor for AVDD as close as possible to both the AVDD and AGND pins. Make a through-hole (TH) near the pins of this capacitor if the board has planes for power and GND.
- The feedback wiring to the OUT should be wired from the voltage output pin closest to the output capacitor (Co). The OUT pin is extremely sensitive and should thus be kept wired away from the LX1 pin and LX2 pin of this IC as far as possible.
- If applying voltage to the VREFIN1/VREFIN2 pins through dividing resistors, arrange the resistors so that the wiring can be kept as short as possible. Also arrange them so that the GND pin of VREFIN1/VREFIN2 resistor is close to the IC's AGND pin. Further, provide a GND exclusively for the control line so that the resistor can be connected via a path that does not carry current. If installing a bypass capacitor for the VREFIN, put it close to the VREFIN pin.
- If applying voltage to the VDET pin through dividing resistors, arrange the resistors so that the wiring can be kept as short as possible. Also arrange so that the GND pin of the VDET resistor is close to the IC's AGND pin. Further, provide a GND exclusively for the control line so that the resistor can be connected via a path that does not carry current.
- Try to make a GND plane on the surface to which this IC will be mounted. For efficient heat dissipation when using the QFN-24 package, FUJITSU SEMICONDUCTOR recommends providing a thermal via in the footprint of the thermal pad.
- Example of arranging IC SW system parts

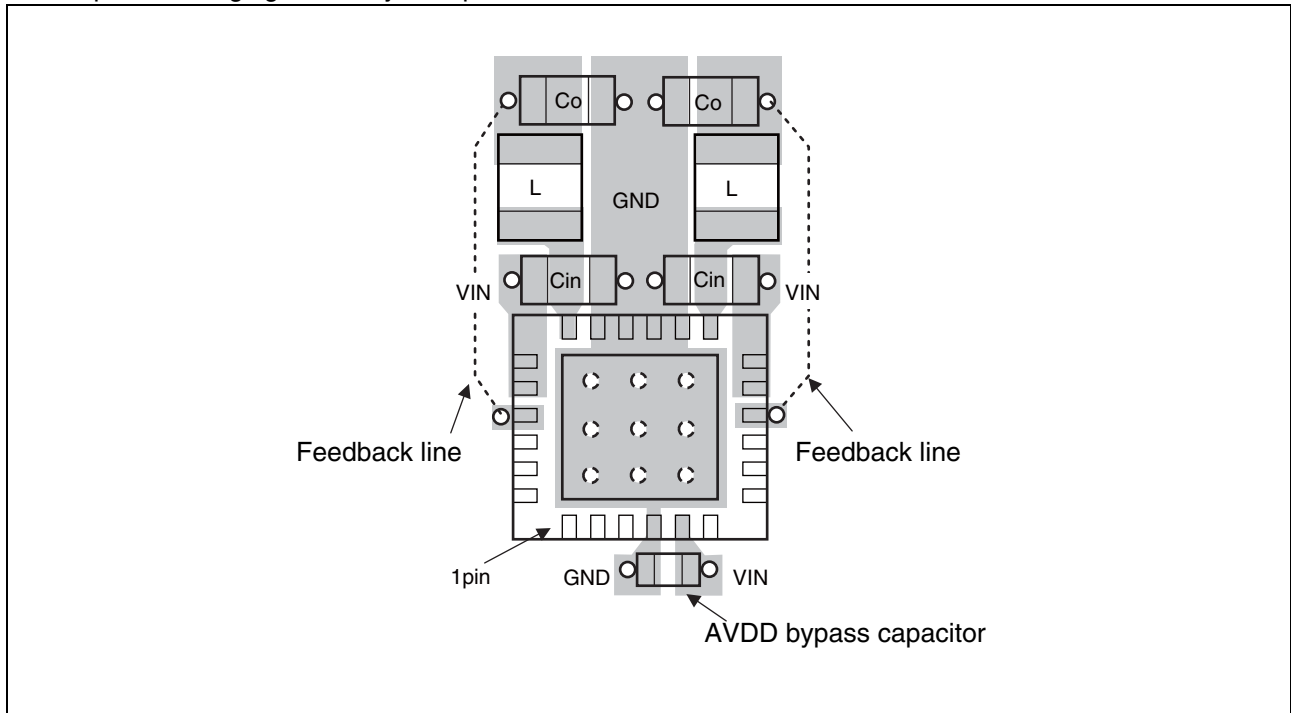

- Notes for circuit design

The switching operation of this IC works by monitoring and controlling the peak current which, incidentally, serves as a form of short-circuit protection. However, do not leave the output short-circuited for long periods of time. If the output is short-circuited where $V_{IN} < 2.9$ V, the current limit value (peak current to the inductor) tends to rise. Leaving in the short-circuit state, the temperature of this IC will continue rising and activate the thermal protection.

Once the thermal protection stops the output, the temperature of the IC will go down and operation will be restarted, after which the output will repeat the starting and stopping.

Although this effect will not destroy the IC, the thermal exposure to the IC over prolonged hours may affect the peripherals surrounding it.

EXAMPLE OF STANDARD OPERATION CHARACTERISTICS

(Shown below is an example of characteristics for connection according to “TEST CIRCUIT FOR MEASURING TYPICAL OPERATING CHARACTERISTICS”.)

- Characteristics CH1

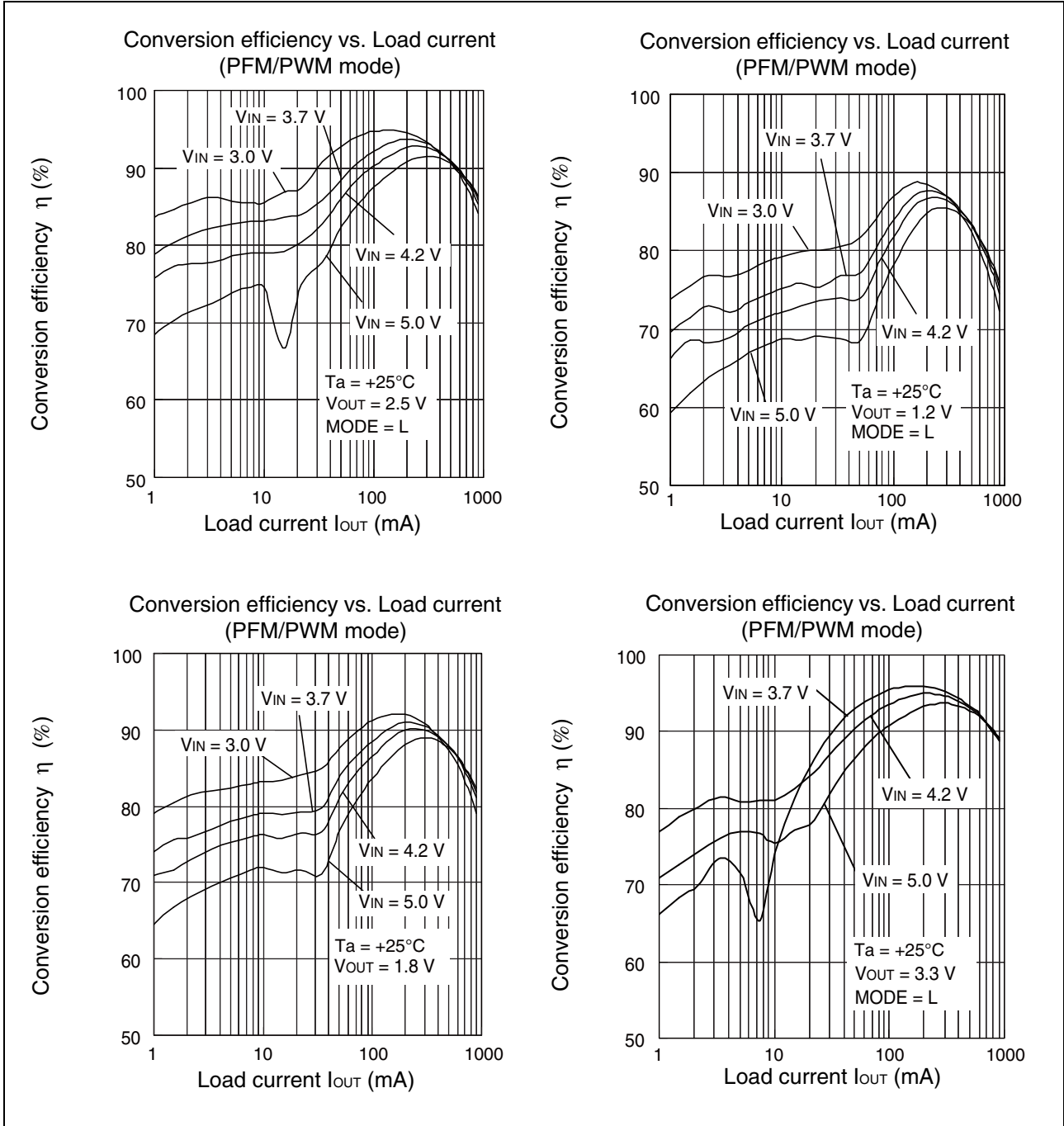

(Continued)

Conversion efficiency vs. Load current
(PWM fixed mode)

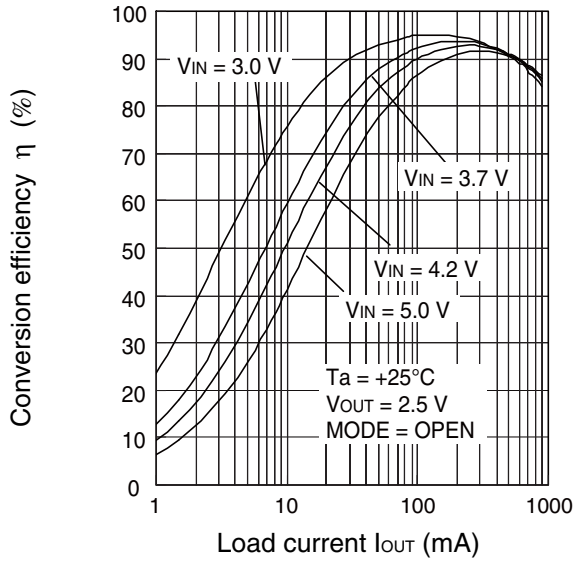

Conversion efficiency vs. Load current
(PWM fixed mode)

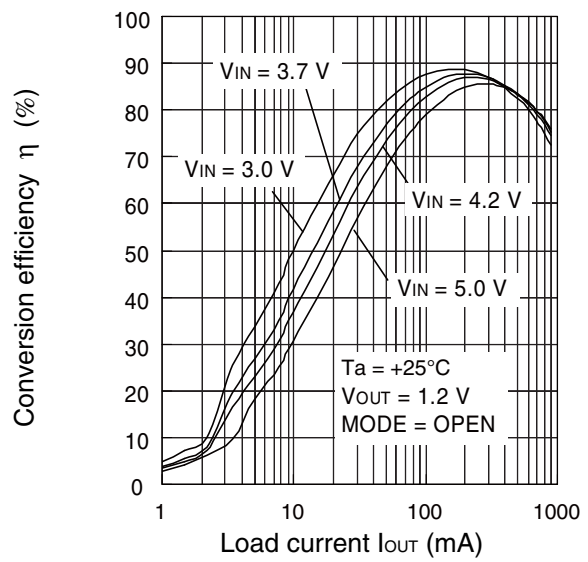

Conversion efficiency vs. Load current
(PWM fixed mode)

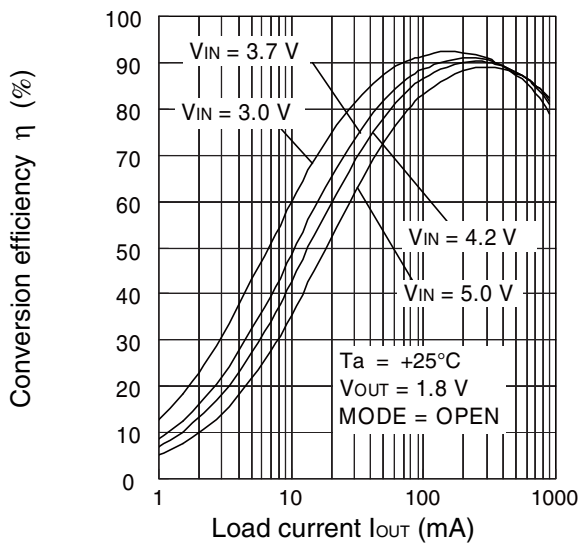

Conversion efficiency vs. Load current
(PWM fixed mode)

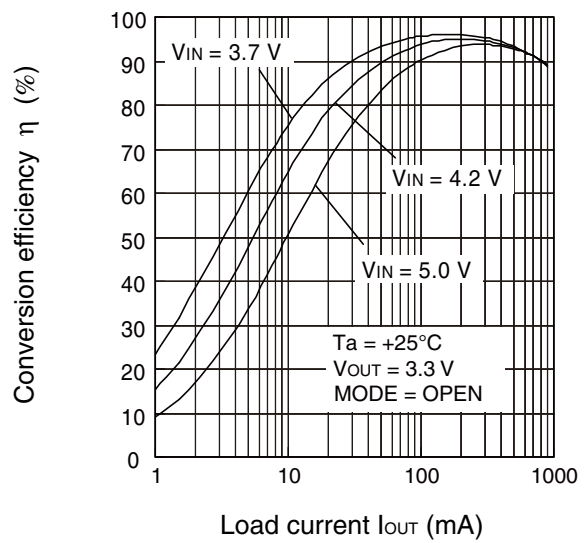

(Continued)

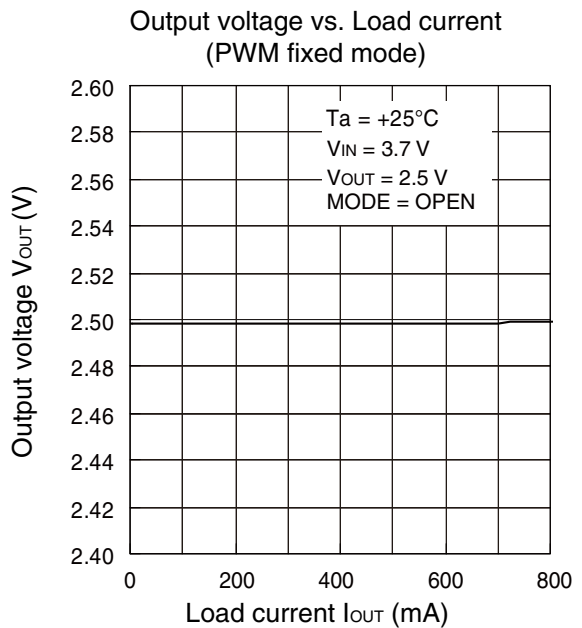
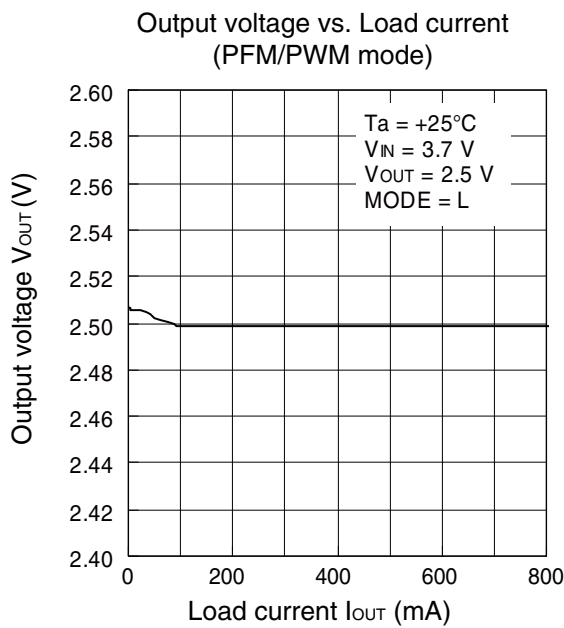
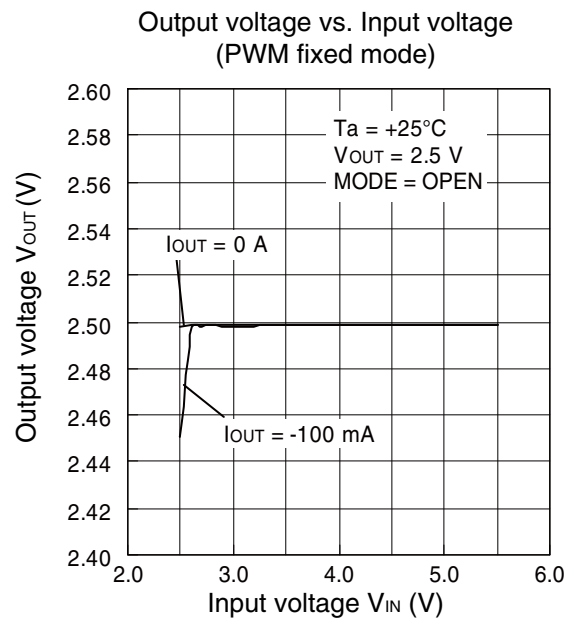
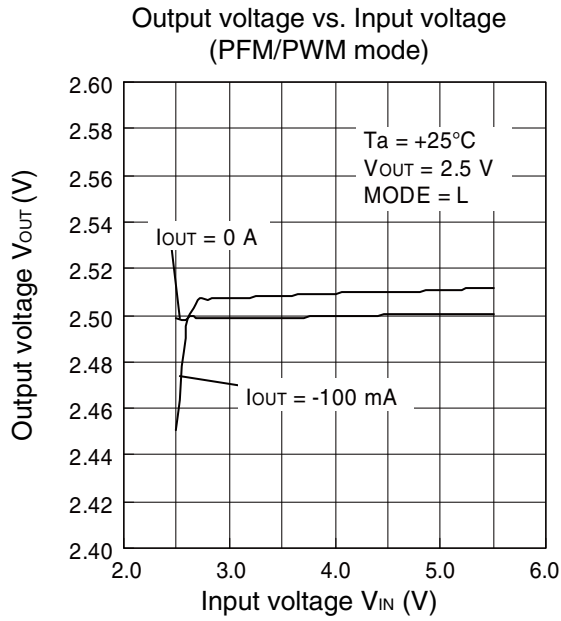

(Continued)

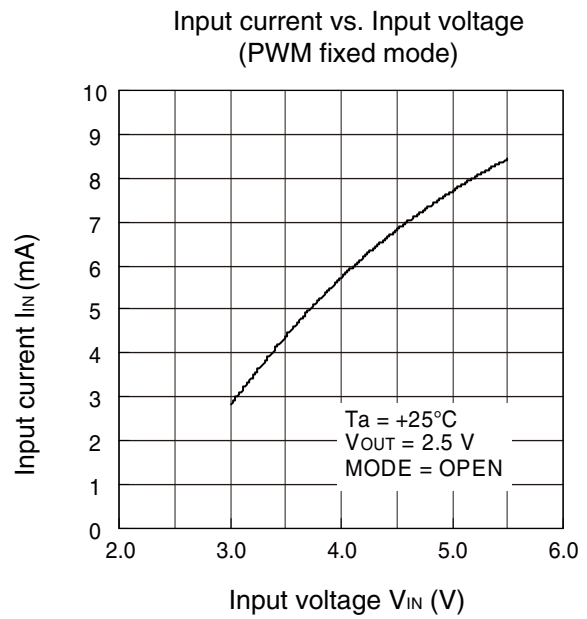
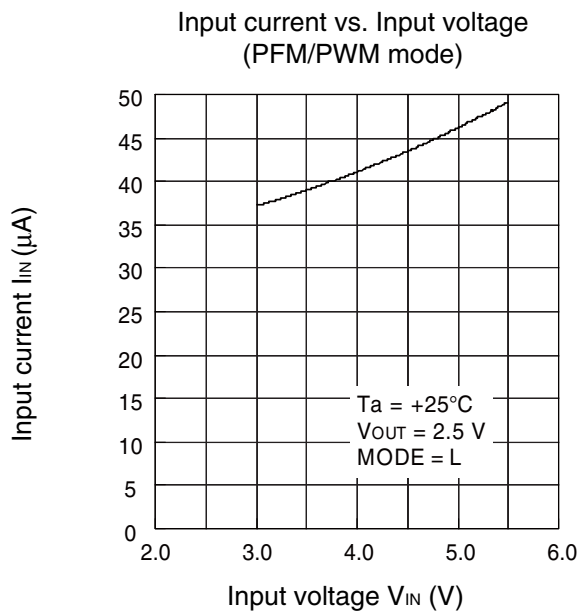
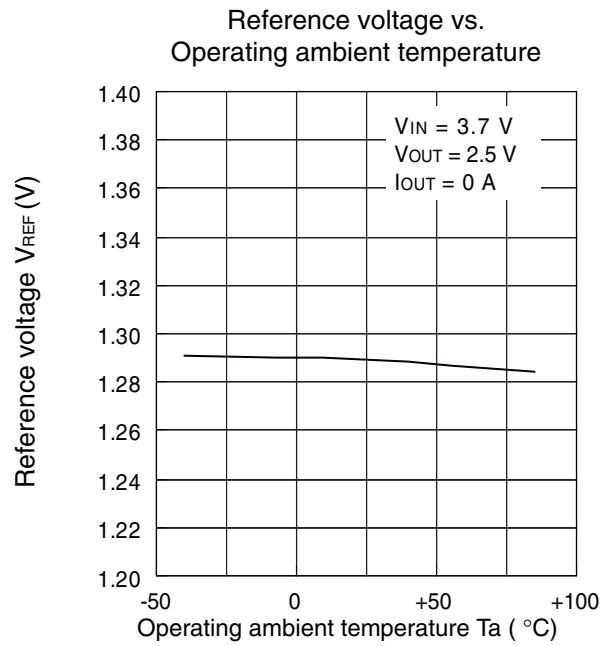
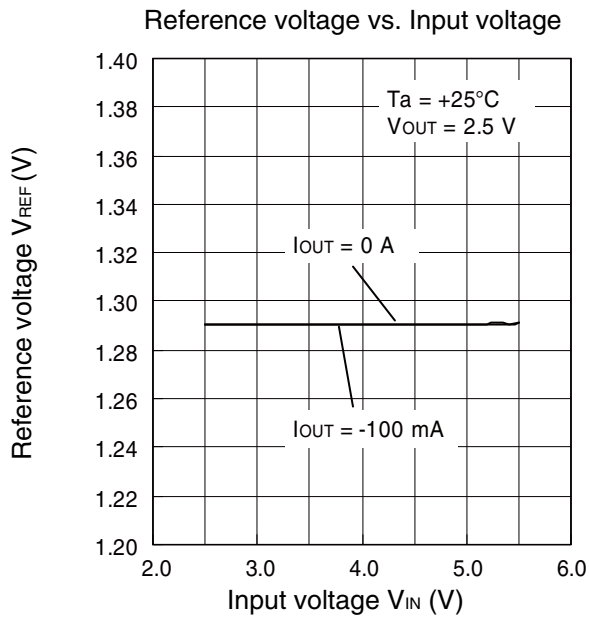

(Continued)

Input current vs. Operating ambient temperature (PFM/PWM mode)

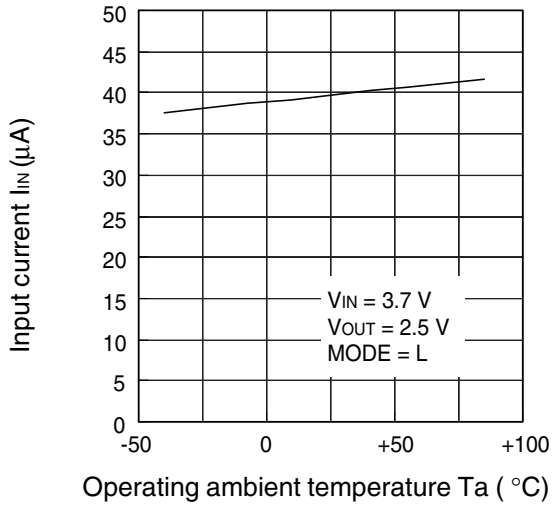

Input current vs. Operating ambient temperature (PWM fixed mode)

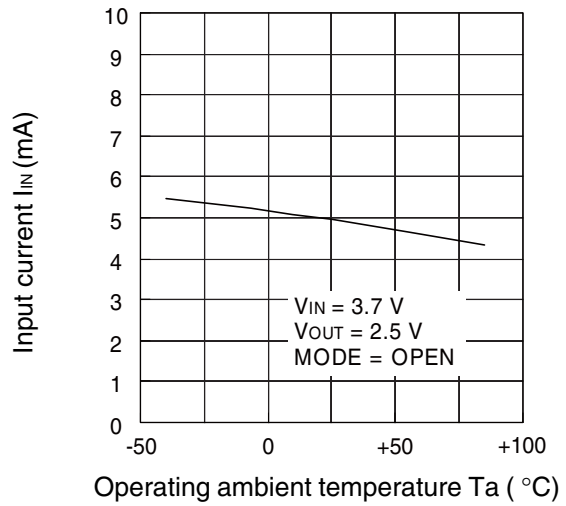

Oscillation frequency vs. Power supply voltage

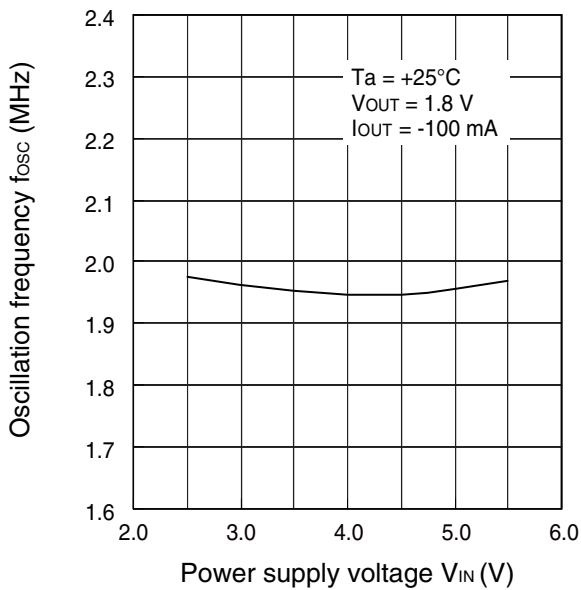

Oscillation frequency vs. Operating ambient temperature

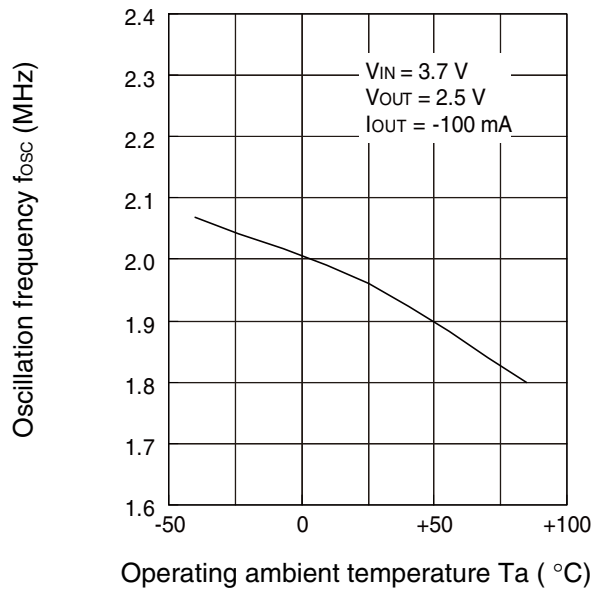

(Continued)

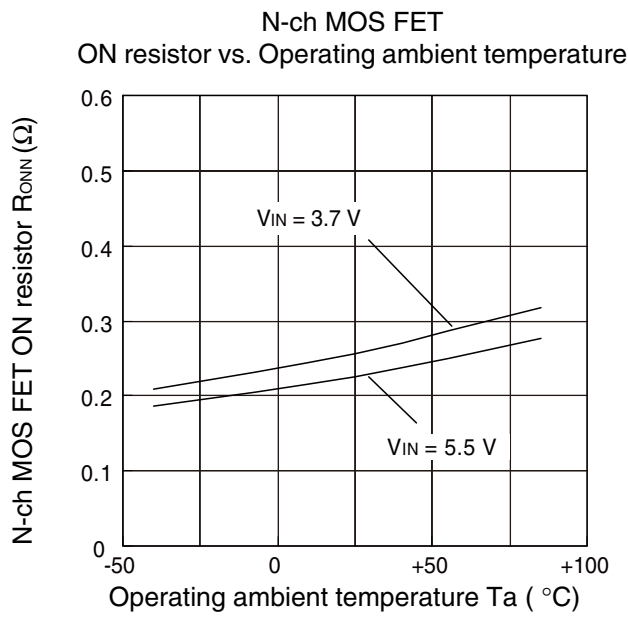
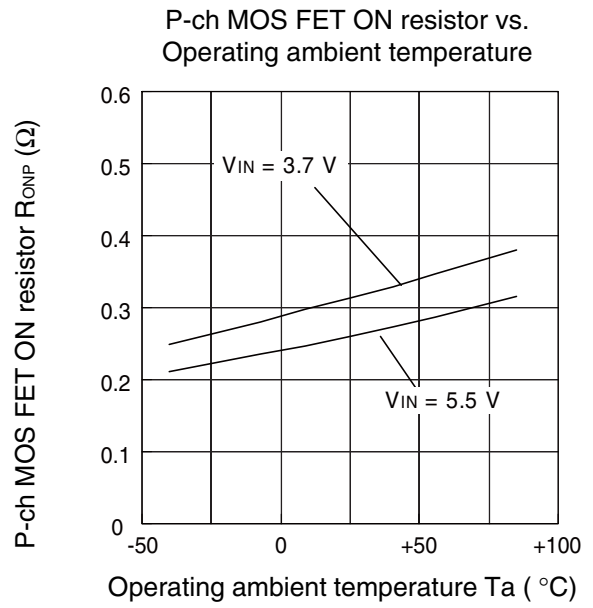
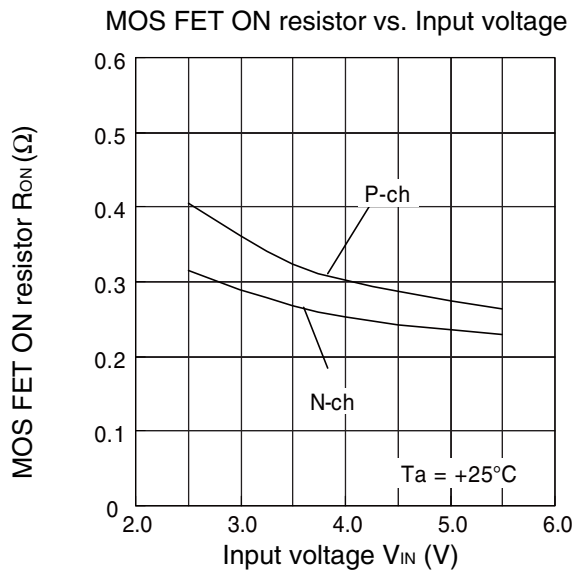

(Continued)

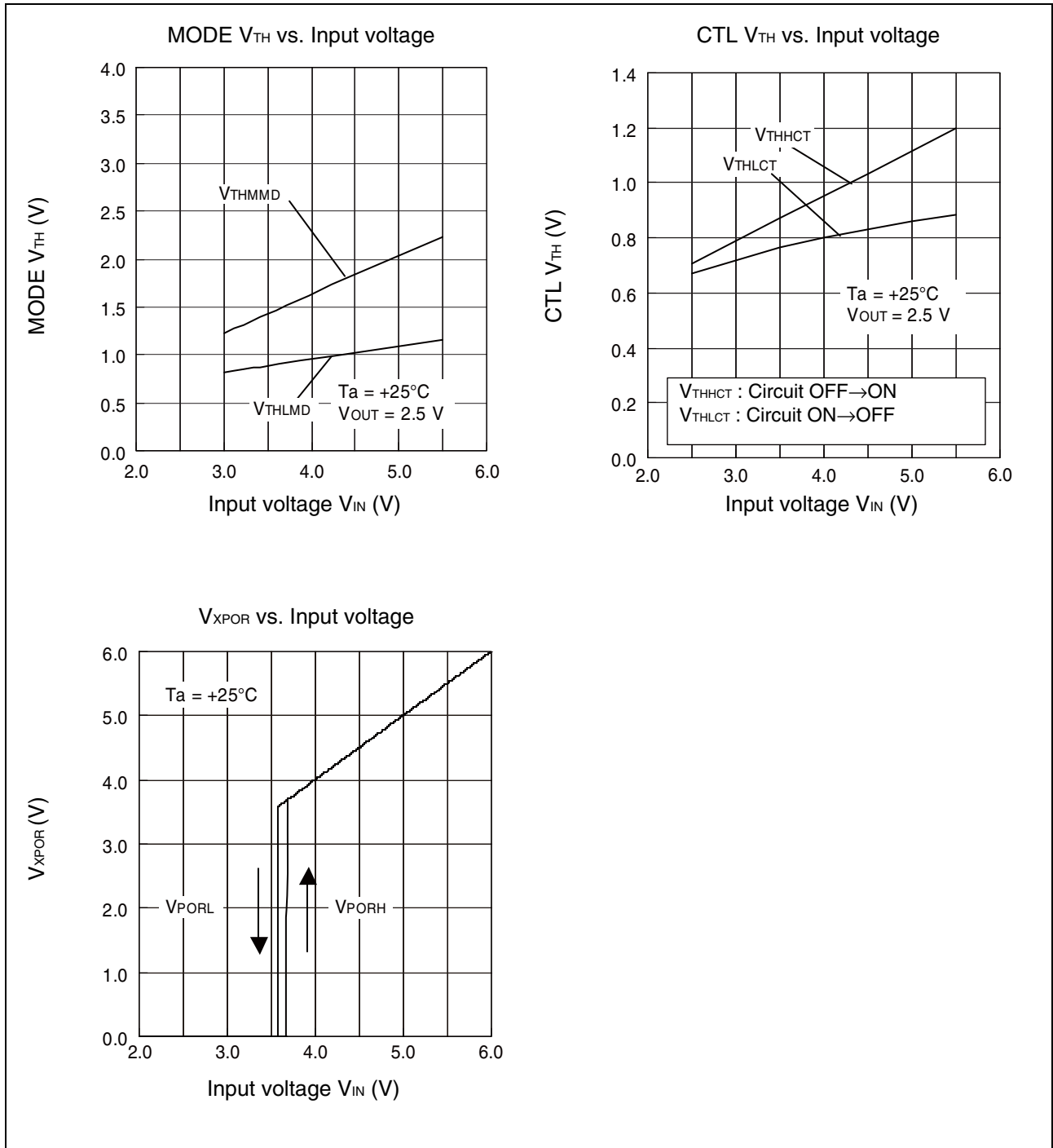

(Continued)

(Continued)

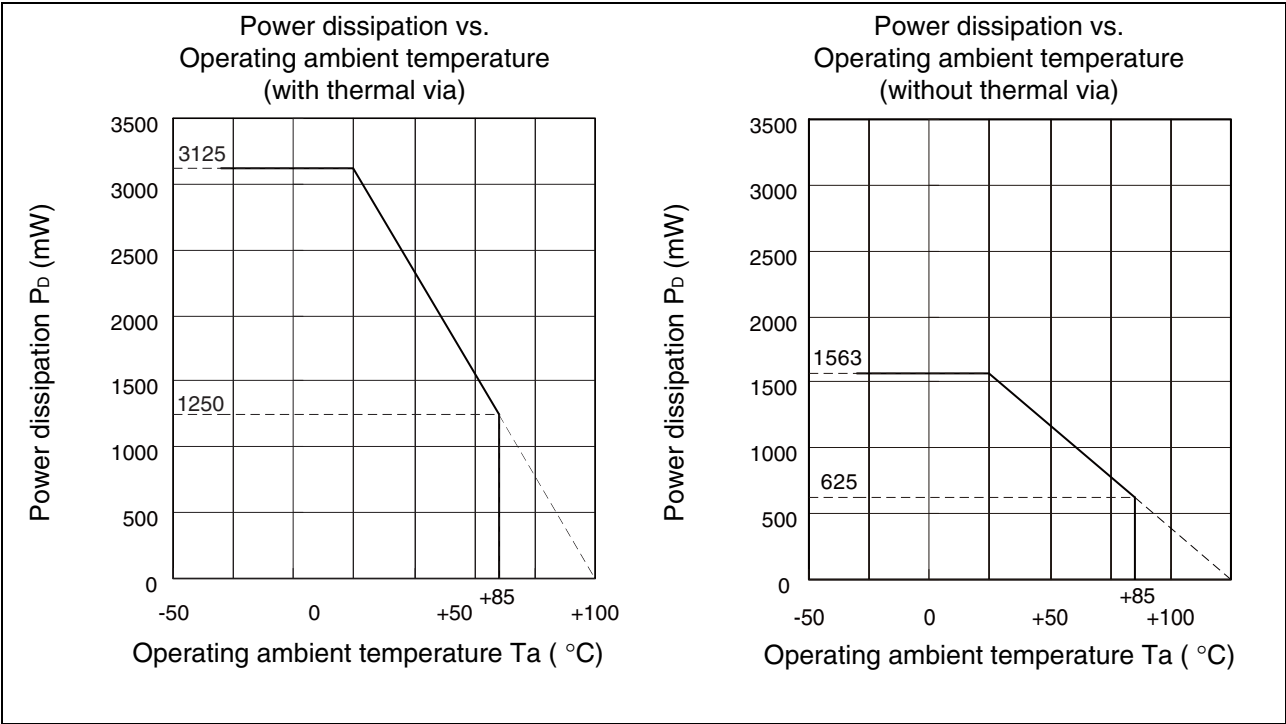

- Switching waveform

PFM/PWM operation

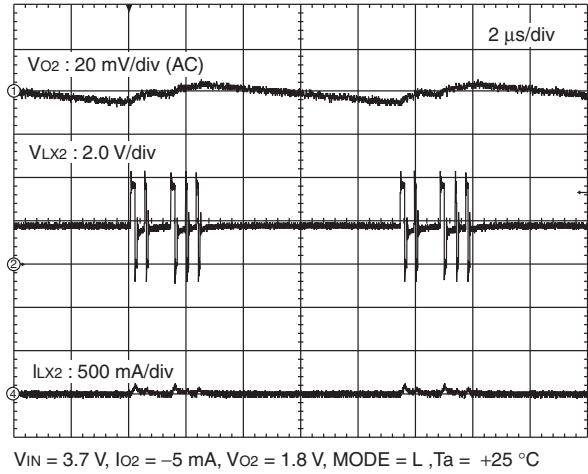
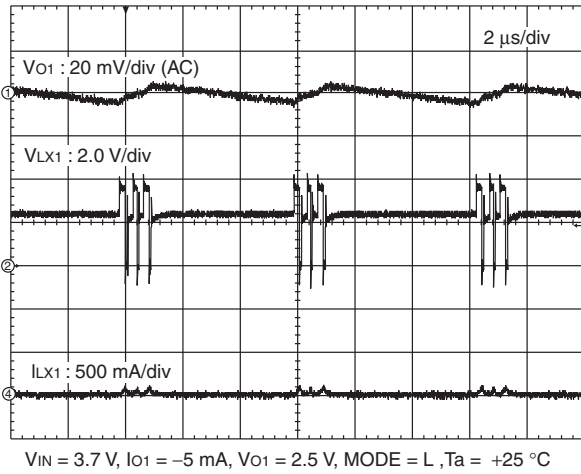

PWM operation

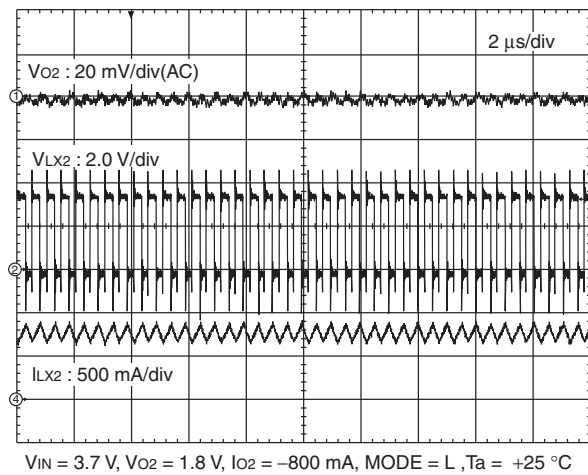
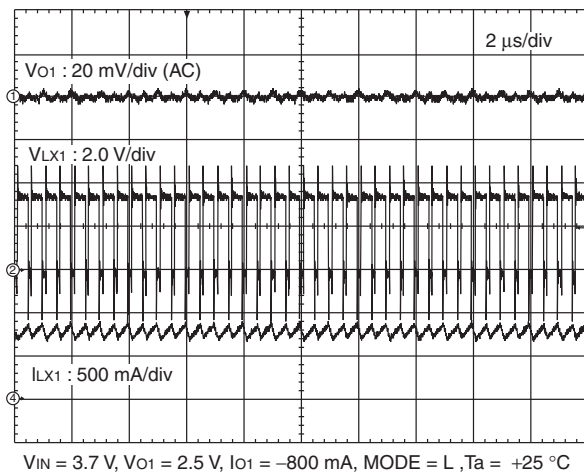

• Output waveforms at sudden load changes

0 A \leftrightarrow - 800 mA

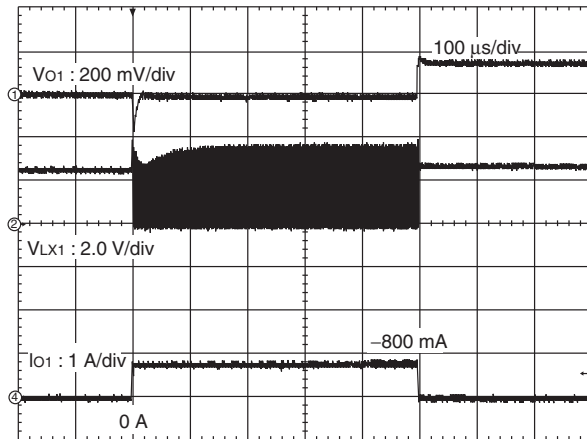

$V_{IN} = 3.7\text{ V}$, $V_{O1} = 2.5\text{ V}$, MODE = L, $T_a = +25\text{ }^\circ\text{C}$

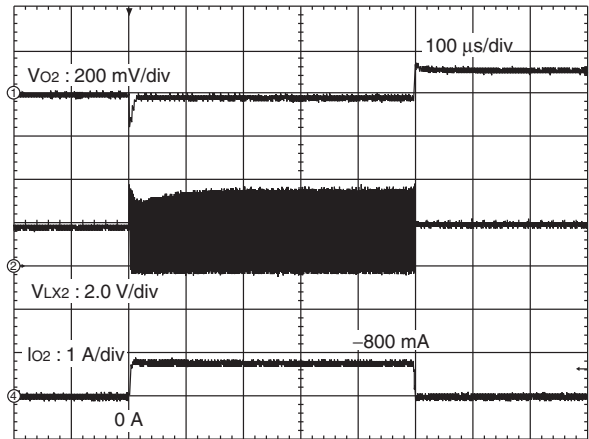

$V_{IN} = 3.7\text{ V}$, $V_{O2} = 1.8\text{ V}$, MODE = L, $T_a = +25\text{ }^\circ\text{C}$

- 20 mA \leftrightarrow - 800 mA

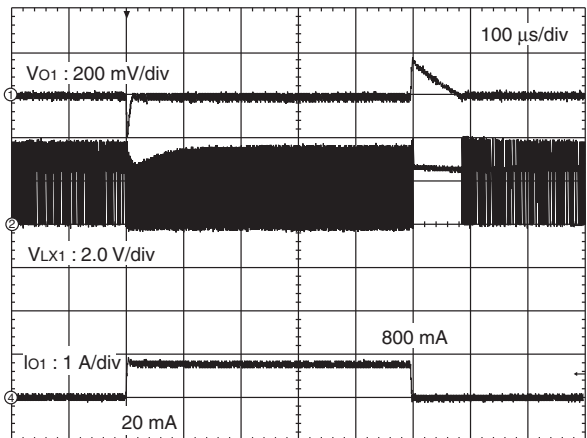

$V_{IN} = 3.7\text{ V}$, $V_{O1} = 2.5\text{ V}$, MODE = L, $T_a = +25\text{ }^\circ\text{C}$

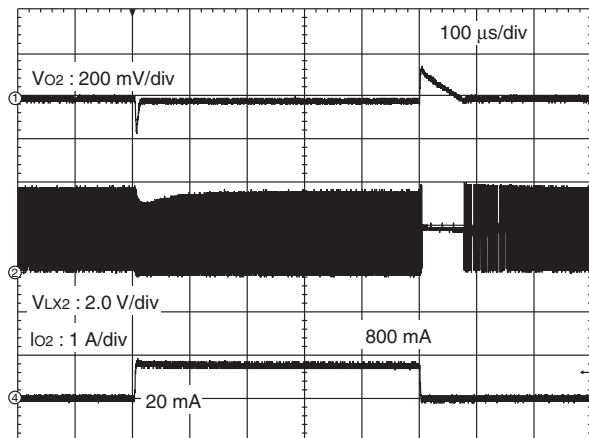

$V_{IN} = 3.7\text{ V}$, $V_{O2} = 1.8\text{ V}$, MODE = L, $T_a = +25\text{ }^\circ\text{C}$

- 100 mA \leftrightarrow - 800 mA

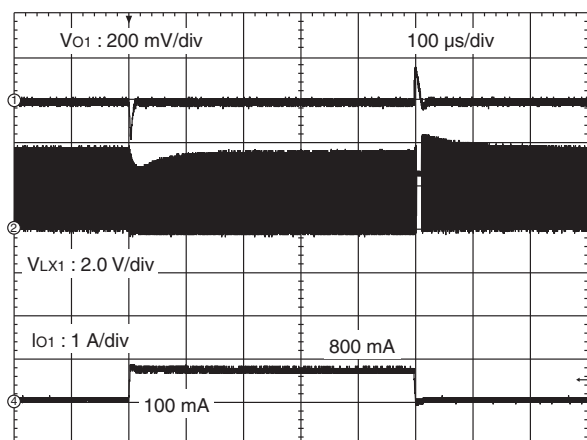

$V_{IN} = 3.7\text{ V}$, $V_{O1} = 2.5\text{ V}$, MODE = L, $T_a = +25\text{ }^\circ\text{C}$

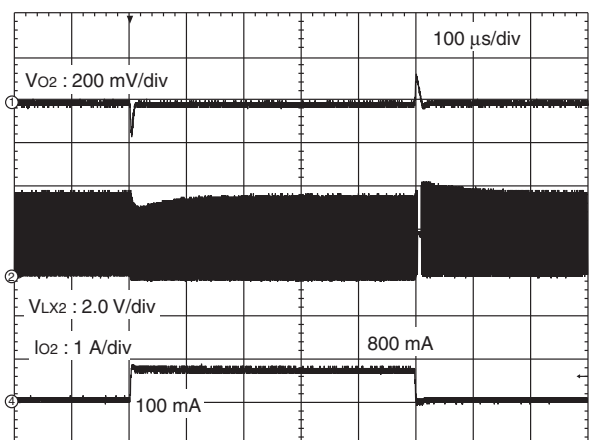

$V_{IN} = 3.7\text{ V}$, $V_{O2} = 1.8\text{ V}$, MODE = L, $T_a = +25\text{ }^\circ\text{C}$

- CTL start-up waveform

No load, No VREFIN capacitor

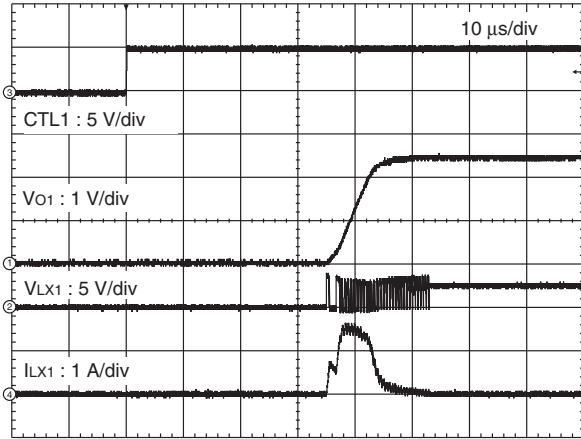

$V_{IN} = 3.7\text{ V}$, $V_{O1} = 2.5\text{ V}$, MODE = L, $T_a = +25\text{ }^\circ\text{C}$

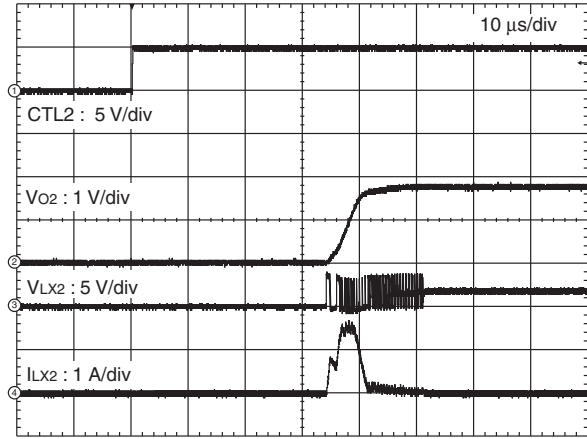

$V_{IN} = 3.7\text{ V}$, $V_{O2} = 1.8\text{ V}$, MODE = L, $T_a = +25\text{ }^\circ\text{C}$

Maximum load, No VREFIN capacitor

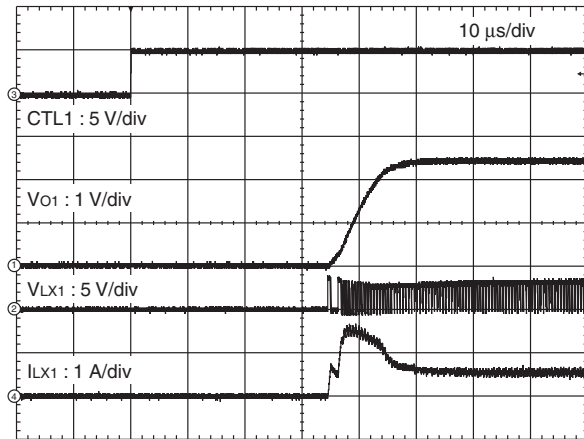

$V_{IN} = 3.7\text{ V}$, $V_{O1} = 2.5\text{ V}$, $I_{O1} = -800\text{ mA}$, MODE = L, $T_a = +25\text{ }^\circ\text{C}$

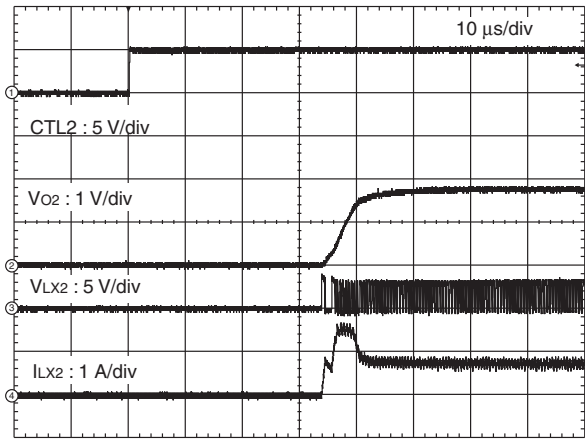

$V_{IN} = 3.7\text{ V}$, $V_{O2} = 1.8\text{ V}$, $I_{O2} = -800\text{ mA}$, MODE = L, $T_a = +25\text{ }^\circ\text{C}$

(Continued)

(Continued)

No load, VREFIN capacitor = 0.1 μ F

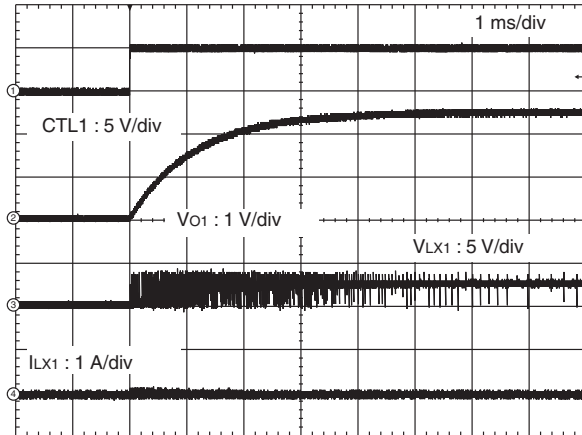

$V_{IN} = 3.7$ V, $V_{O1} = 2.5$ V, MODE = L, $T_a = +25$ °C

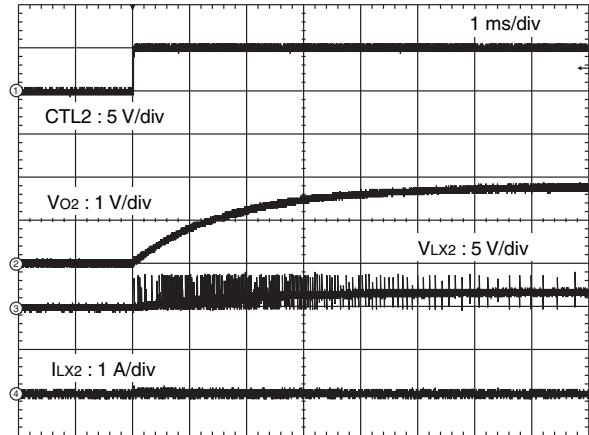

$V_{IN} = 3.7$ V, $V_{O2} = 1.8$ V, MODE = L, $T_a = +25$ °C

Maximum load, VREFIN capacitor = 0.1 μ F

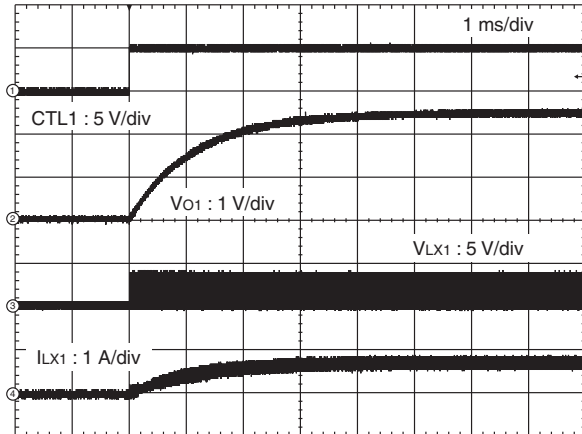

$V_{IN} = 3.7$ V, $V_{O1} = 2.5$ V, $I_{O1} = -800$ mA, MODE = L, $T_a = +25$ °C

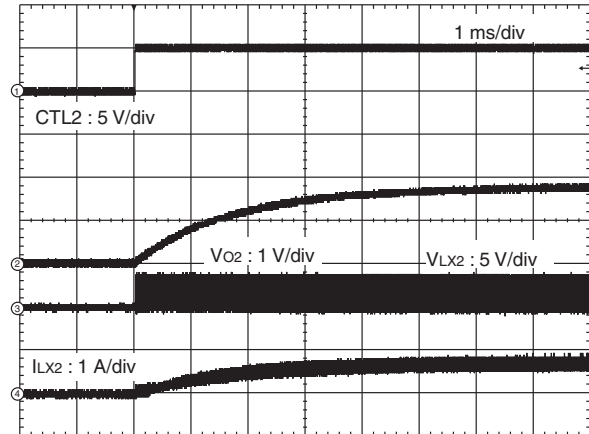

$V_{IN} = 3.7$ V, $V_{O2} = 1.8$ V, $I_{O2} = -800$ mA, MODE = L, $T_a = +25$ °C

- CTL stop waveform

Maximum load, VREFIN capacitor = 0.1 μ F

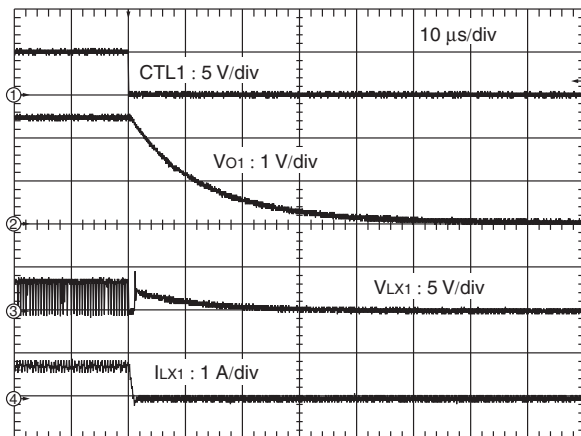

$V_{IN} = 3.7$ V, $V_{O1} = 2.5$ V, $I_{O1} = -800$ mA, MODE = L, $T_a = +25$ °C

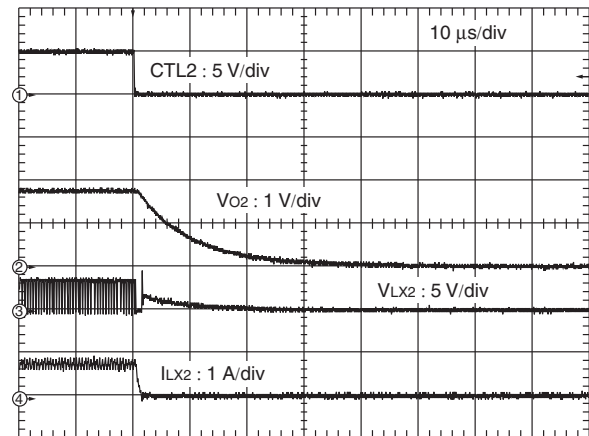

$V_{IN} = 3.7$ V, $V_{O2} = 1.8$ V, $I_{O2} = -800$ mA, MODE = L, $T_a = +25$ °C

• Current limitation waveform

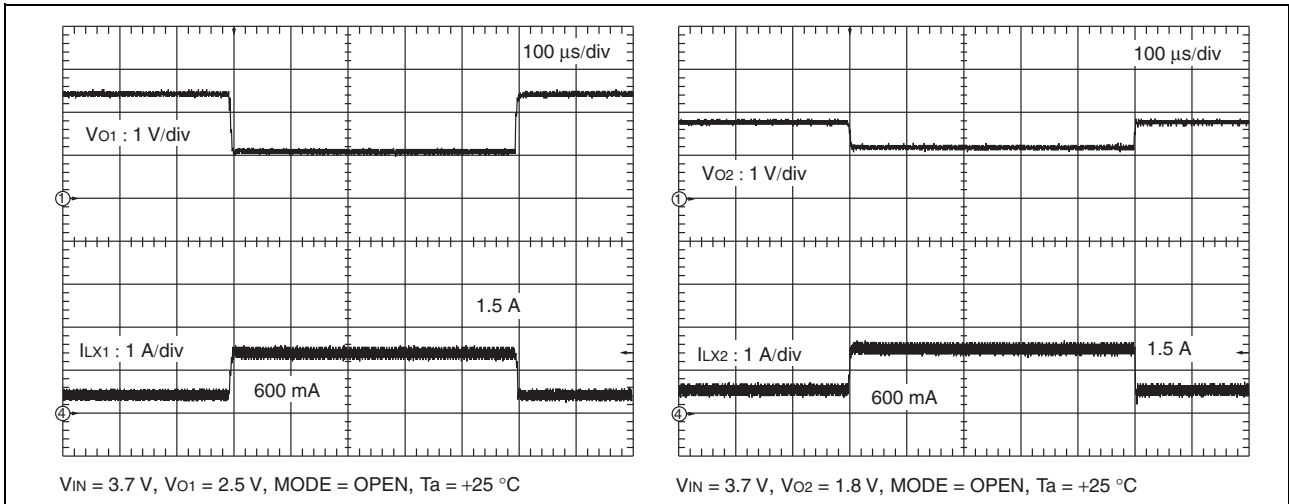

• Voltage detection waveform

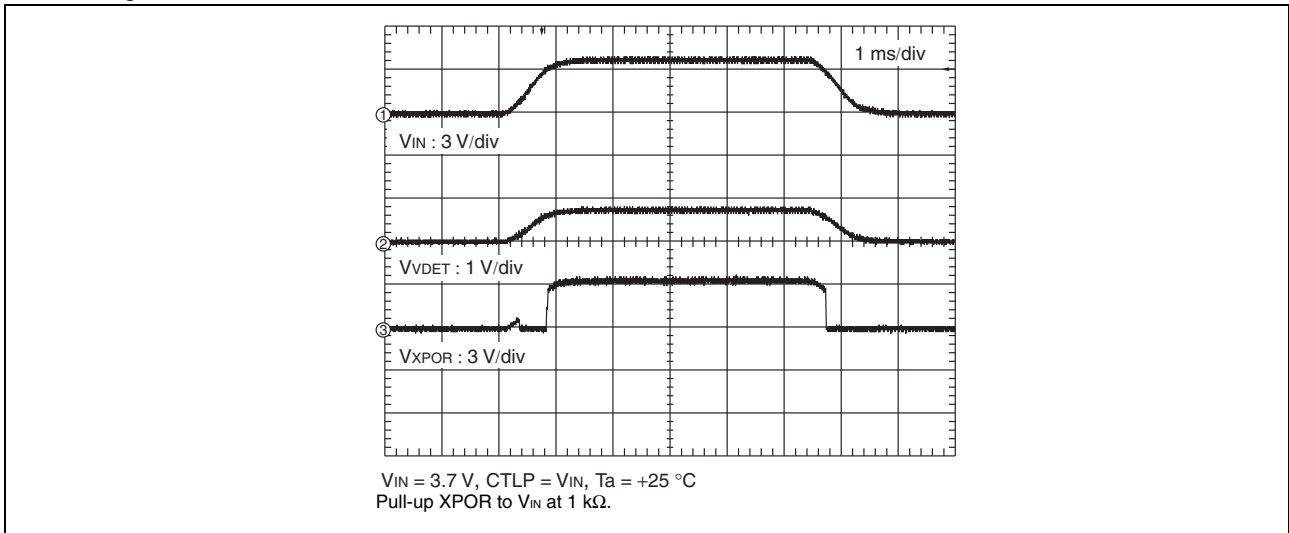

• Waveform of dynamic output voltage transition ($V_{O1} 1.8 \text{ V} \leftrightarrow 2.5 \text{ V}$)

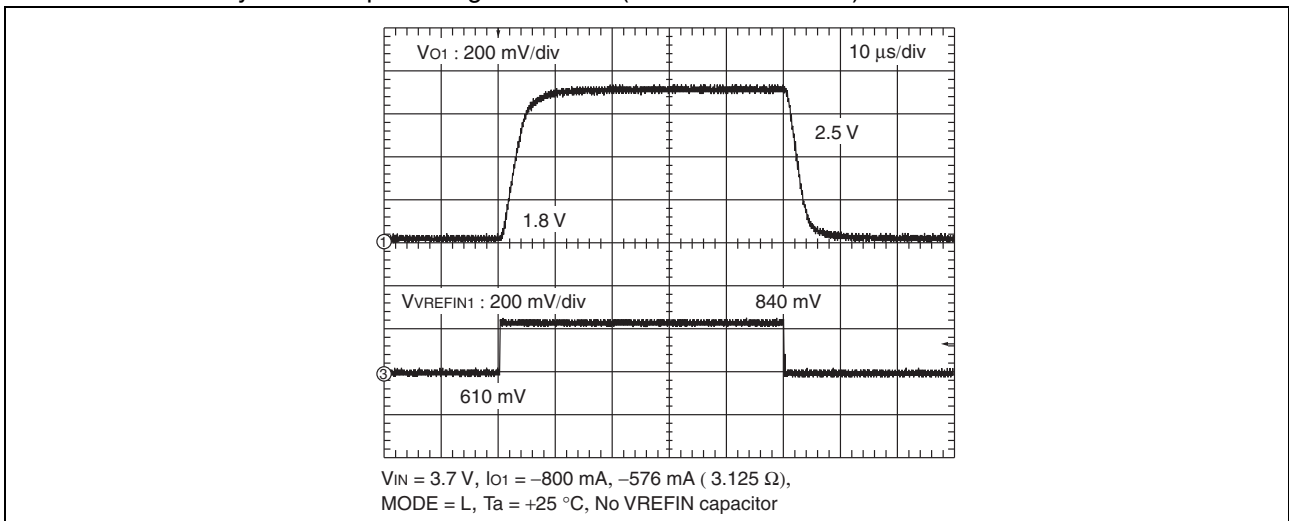

APPLICATION CIRCUIT EXAMPLES

APPLICATION CIRCUIT EXAMPLE 1

- An external voltage is input to the reference voltage external input (VREFIN1, VREFIN2), and the V_{OUT} voltage is set to 2.97 times the V_{OUT} setting gain.

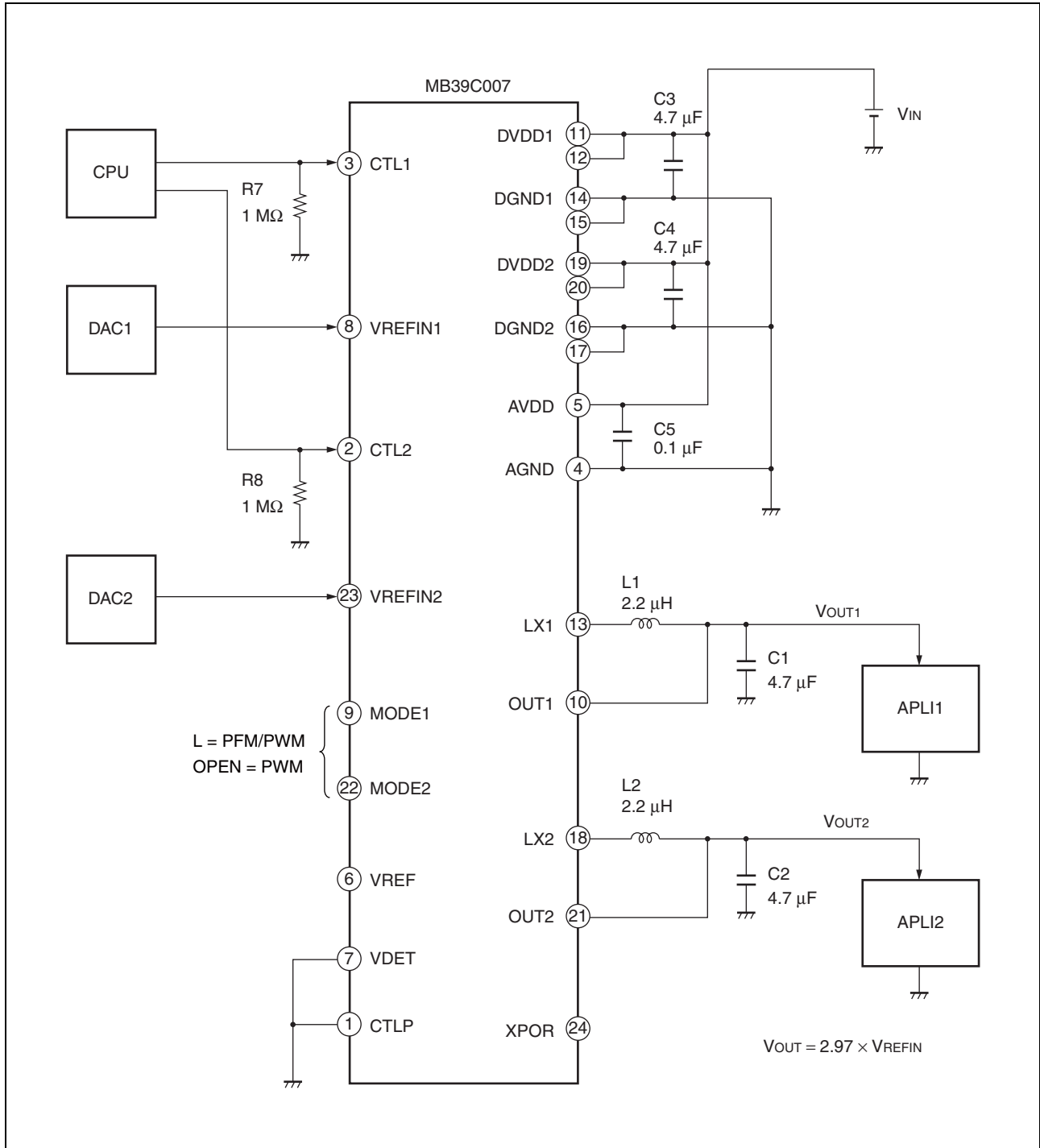

• APPLICATION CIRCUIT EXAMPLE 2

- The voltage of VREF pin is input to the reference voltage external input (VREFIN1, VREFIN2) by dividing resistors. The V_{OUT1} voltage is set to 2.5 V and V_{OUT2} voltage is set to 1.8 V.

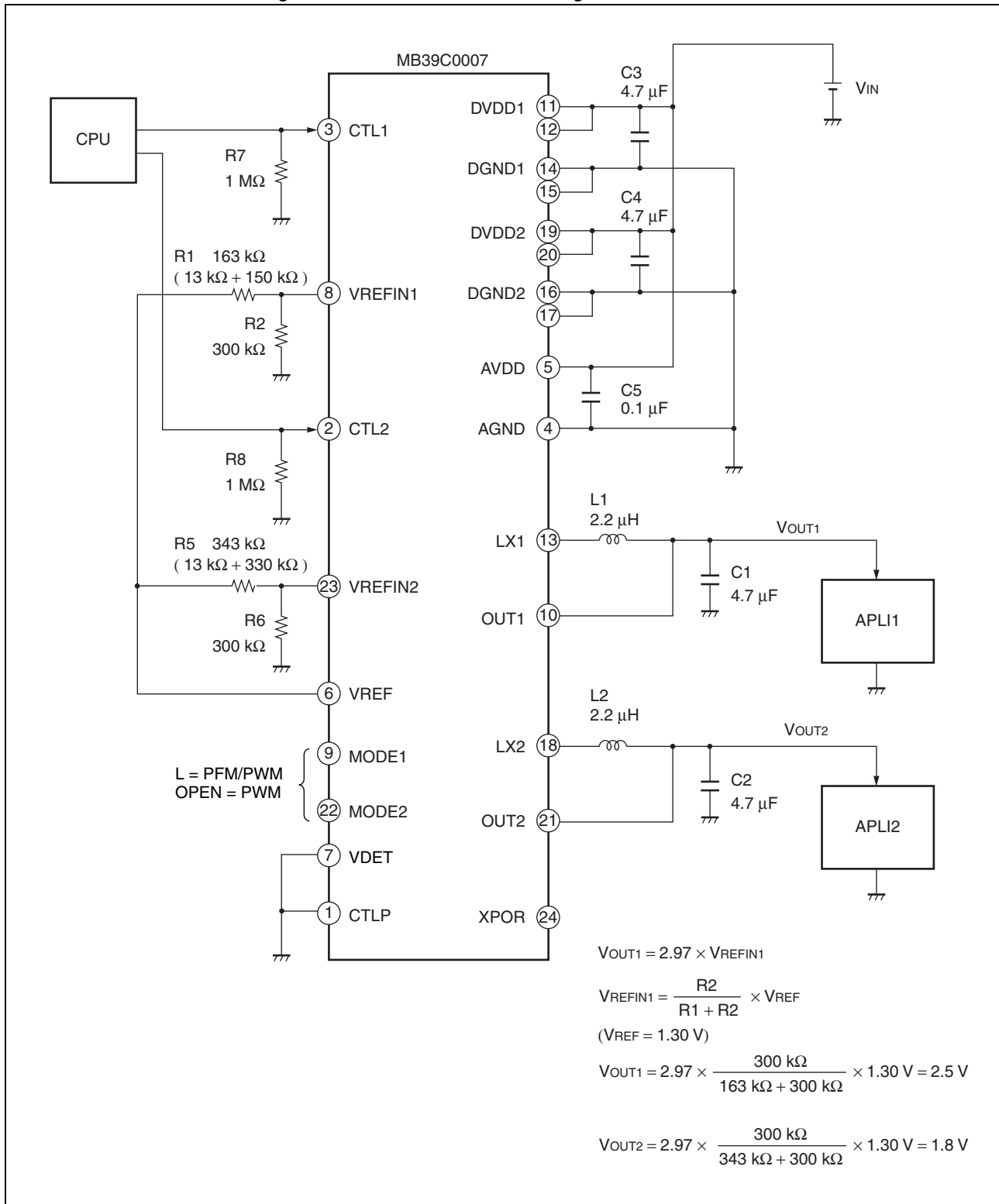

• APPLICATION CIRCUIT EXAMPLE COMPONENTS LIST

Component	Item	Part Number	Specification	Package	Vendor
L1	Inductor	VL4012AT-2R2M	2.2 μ H, RDC = 76 m Ω	SMD	TDK
		MIPW3226D2R2M	2.2 μ H, RDC = 100 m Ω	SMD	FDK
L2	Inductor	VL4012AT-2R2M	2.2 μ H, RDC = 76 m Ω	SMD	TDK
		MIPW3226D2R2M	2.2 μ H, RDC = 100 m Ω	SMD	FDK
C1	Ceramic capacitor	C2012JB1A475K	4.7 μ F (10 V)	2012	TDK
C2	Ceramic capacitor	C2012JB1A475K	4.7 μ F (10 V)	2012	TDK
C3	Ceramic capacitor	C2012JB1A475K	4.7 μ F (10 V)	2012	TDK
C4	Ceramic capacitor	C2012JB1A475K	4.7 μ F (10 V)	2012	TDK
C5	Ceramic capacitor	C1608JB1E104K	0.1 μ F (50 V)	2012	TDK
R1	Resistor	RK73G1JTDD D 13 k Ω	13 k Ω	1608	KOA
		RK73G1JTDD D 150 k Ω	150 k Ω	1608	KOA
R2	Resistor	RK73G1JTDD D 300 k Ω	300 k Ω	1608	KOA
R5	Resistor	RK73G1JTDD D 13 k Ω	13 k Ω	1608	KOA
		RK73G1JTDD D 330 k Ω	330 k Ω	1608	KOA
R6	Resistor	RK73G1JTDD D 300 k Ω	300 k Ω	1608	KOA
R7	Resistor	RK73G1JTDD D 1 M Ω	1 M Ω \pm 0.5%	1608	KOA
R8	Resistor	RK73G1JTDD D 1 M Ω	1 M Ω \pm 0.5%	1608	KOA

TDK : TDK Corporation
 FDK : FDK Corporation
 KOA : KOA Corporation

■ USAGE PRECAUTIONS

1. Do not configure the IC over the maximum ratings

If the IC is used over the maximum ratings, the LSI may be permanently damaged.

It is preferable for the device to normally operate within the recommended usage conditions. Usage outside of these conditions adversely affect the reliability of the LSI.

2. Use the devices within recommended operating conditions

The recommended operating conditions are the conditions under which the LSI is guaranteed to operate. The electrical ratings are guaranteed when the device is used within the recommended operating conditions and under the conditions stated for each item.

3. Printed circuit board ground lines should be set up with consideration for common impedance

4. Take appropriate static electricity measures

- Containers for semiconductor materials should have anti-static protection or be made of conductive material.
- After mounting, printed circuit boards should be stored and shipped in conductive bags or containers.
- Work platforms, tools, and instruments should be properly grounded.
- Working personnel should be grounded with resistance of 250 k Ω to 1 M Ω between body and ground.

5. Do not apply negative voltages

The use of negative voltages below -0.3 V may create parasitic transistors on LSI lines, which can cause abnormal operation.

■ ORDERING INFORMATION

Part number	Package	Remarks
MB39C007WQN	24-pin plastic QFN (LCC-24P-M10)	

■ RoHS COMPLIANCE INFORMATION OF LEAD (Pb) FREE VERSION

The LSI products of FUJITSU SEMICONDUCTOR with “E1” are compliant with RoHS Directive, and has observed the standard of lead, cadmium, mercury, hexavalent chromium, polybrominated biphenyls (PBB), and polybrominated diphenyl ethers (PBDE).

A product whose part number has trailing characters “E1” is RoHS compliant.

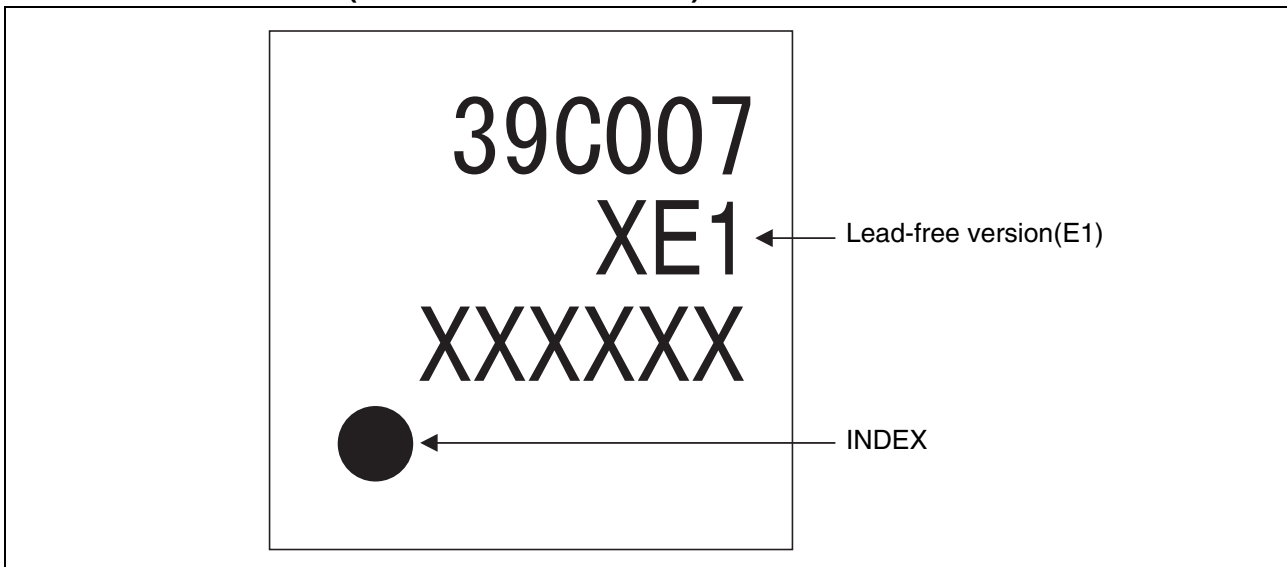

■ MARKING FORMAT (LEAD FREE VERSION)



■ LABELING SAMPLE (LEAD FREE VERSION)

Lead-free mark

JEITA logo JEDEC logo

MB123456P - 789 - GE1
 (3N) 1MB123456P-789-GE1 1000

 (3N)2 1561190005 107210
 QC PASS
 1,000 PCS
 MB123456P - 789 - GE1

2006/03/01 ASSEMBLED IN JAPAN
 MB123456P - 789 - GE1 1/1 0605 - Z01A 1000

 1561190005

The part number of a lead-free product has the trailing characters "E1".

"ASSEMBLED IN CHINA" is printed on the label of a product assembled in China.

■ EVALUATION BOARD SPECIFICATION

The MB39C007 Evaluation Board provides the proper for evaluating the efficiency and other characteristics of the MB39C007.

• Terminal information

Symbol	Functions
VIN	Power supply terminal In standard condition 3.1 V to 5.5 V* * : When the VIN/VOUT difference is to be held within 0.6 V or less, such as for devices with a standard output voltage (VOUT1 = 2.5 V) when VIN < 3.1 V, FUJITSU SEMI-CONDUCTOR recommends changing the output capacity (C1, C2) to 10 μF.
VOUT1, VOUT2	Output terminals (VOUT1: CH1, VOUT2: CH2)
VCTL	Power supply terminal for setting the CTL1, CTL2 and CTLP terminals. Use by connecting with VIN (When SW is mounted).
CTL1, CTL2	Direct supply terminal of CTL (CTL1 : for CH1, CTL2 : for CH2) CTL1, CTL2 = 0 V to 0.8 V (Typ.) : Shutdown CTL1, CTL2 = 0.95 V (Typ.) to VIN (5 V Max) : Normal operation
MODE1, MODE2	Direct supply terminal of MODE (CH1 : for MODE1, CH2 : for MODE2) MODE1, MODE2 = 0 V to 0.4 V(Max) : PFM/PWM mode MODE1, MODE2 = OPEN(Remove R1 and R4) : PWM mode
VREF	Reference voltage output terminal VREF = 1.30 V (Typ.)
VREFIN1, VREFIN2	External reference voltage input terminals (VREFIN1 : for CH1, VREFIN2 : for CH2) When an external reference voltage is supplied, connect it to the terminal for each channel.
VDET	Voltage input terminal for voltage detection
CTLP	Voltage detection circuit block control terminal CTLP = L : Voltage detection circuit block stop CTLP = H : Normal operation
XPOR	Voltage detection circuit output terminal The N-ch MOS open drain circuit is connected.
VXPOR	Pull-up voltage terminal for the XPOR terminal
PGND	Ground terminal Connect power supply GND to the PGND terminal next to the VIN terminal. Connect output (load) GND to the PGND terminal between the VOUT1 terminal and the VOUT2 terminal.
AGND	Ground terminal

• Startup terminal information

Terminal name	Condition	Functions
CTL1	L : Open H : Connect to VIN	ON/OFF switch for CH1 L : Shutdown H : Normal operation.
CTL2	L : Open H : Connect to VIN	ON/OFF switch for CH2 L : Shutdown H : Normal operation.
CTLP	L : Open H : Connect to VIN	ON/OFF switch for the voltage detection block L : Stops the voltage detection circuit H : Normal operation.

• Jumper information

JP	Functions
JP1	Short-circuited in the layout pattern of the board (normally used shorted).
JP2	Short-circuited in the layout pattern of the board (normally used shorted).
JP3	Not mounted
JP6	Normally used shorted (0 Ω)

• Setup and checkup

(1) Setup

1. Connect the CTL1 terminal and the CTL2 terminal to the VIN terminal.
2. Put it into "L" state by connecting the CTLP terminal to the AGND pad.
3. Connect the power supply terminal to the VIN terminal, and the power supply GND terminal to the PGND terminal. Make sure PGND is connected to the PGND terminal next to the VIN terminal.
(Example of setting power-supply voltage : 3.7 V)

(2) Checkup

Supply power to VIN. The IC is operating normally if VOUT1 = 2.5 V (Typ) and VOUT2 = 1.8 V (Typ).

MB39C007

- Component layout on the evaluation board (Top View)

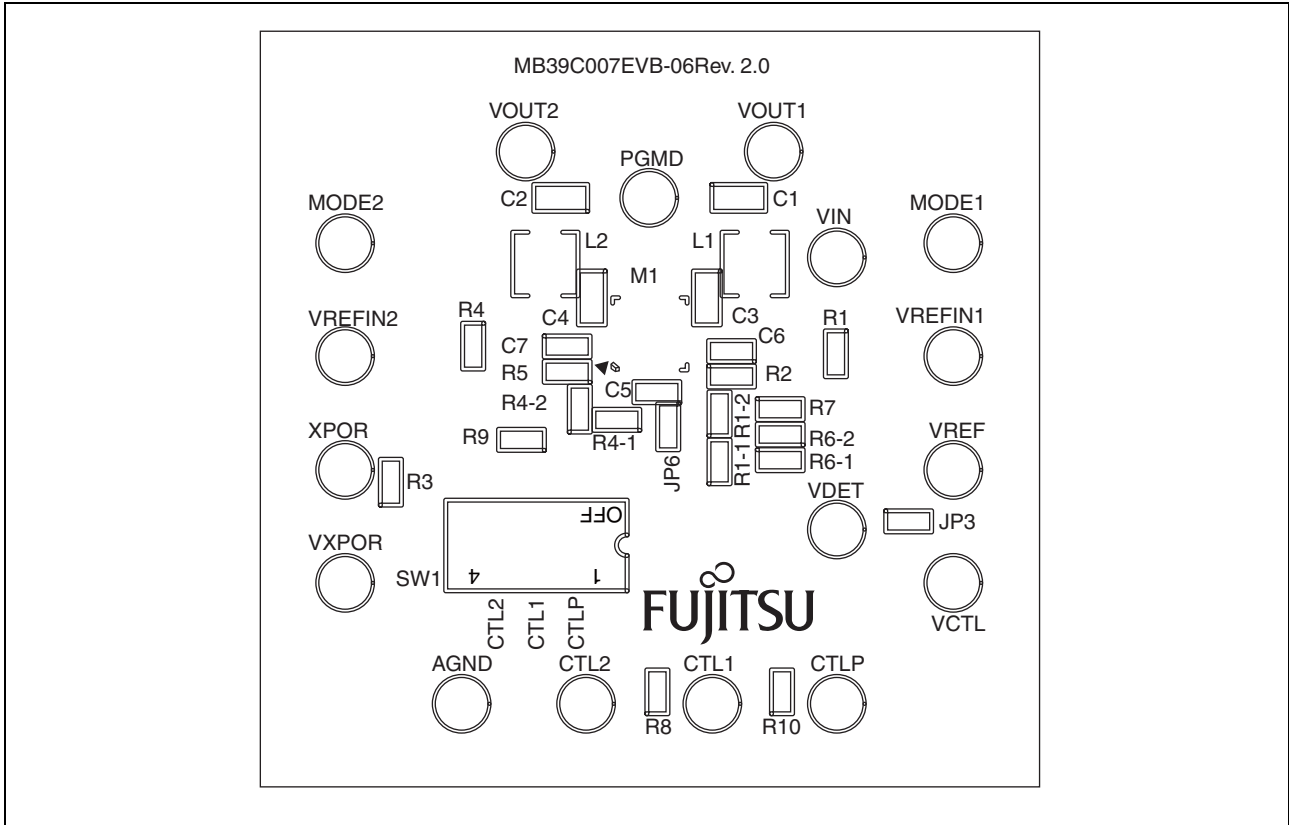

• Evaluation board layout (Top View)

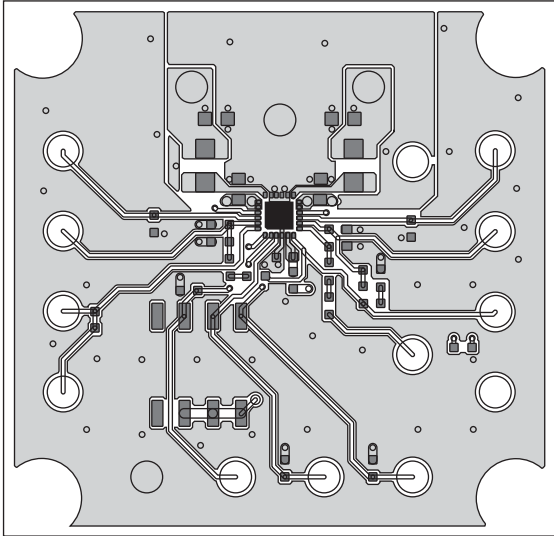

Top Side (Layer1)

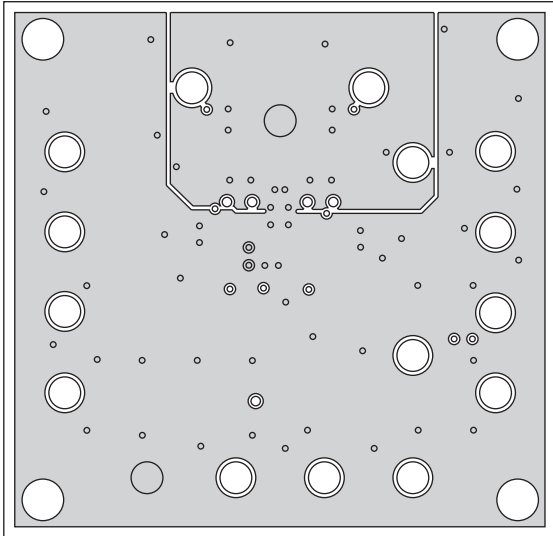

Inside GND (Layer2)

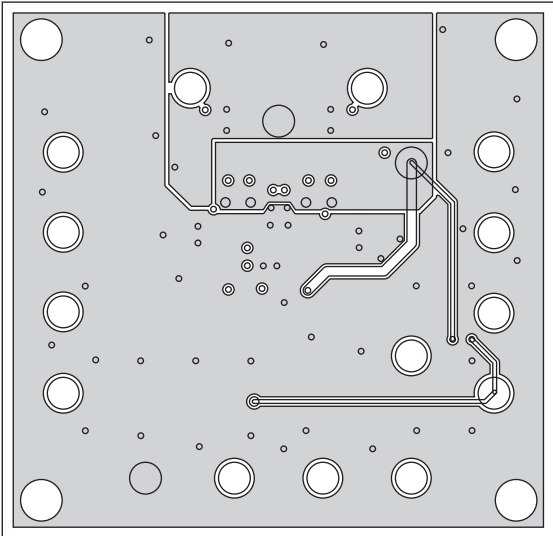

Inside VIN & GND (Layer3)

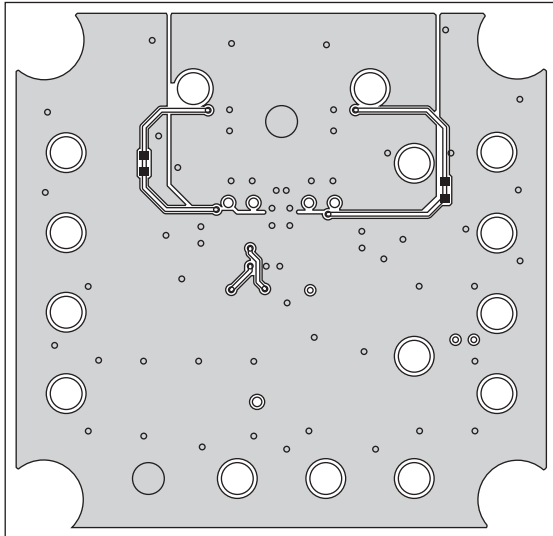

Bottom Side (Layer4)

MB39C007

• Connection diagram

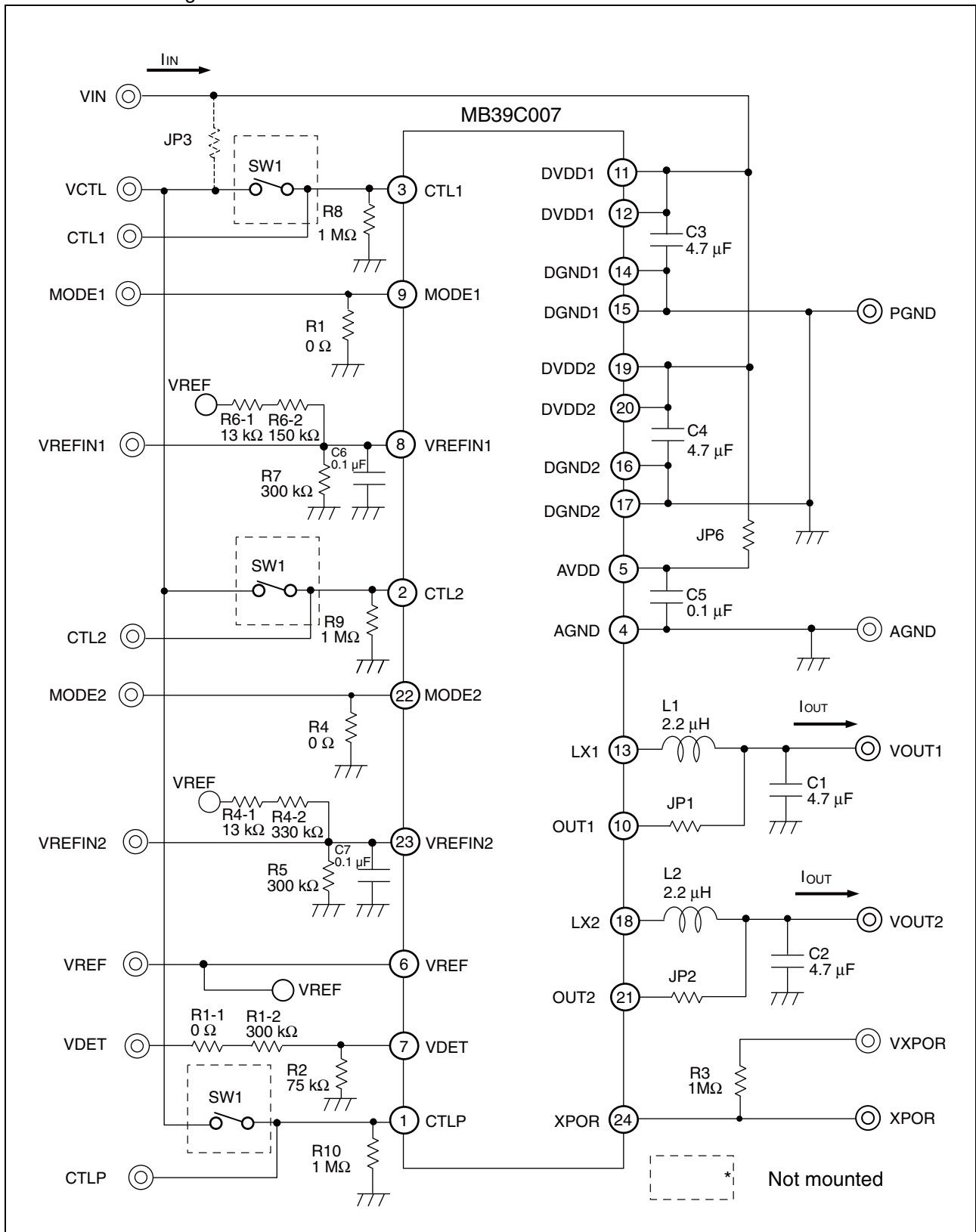

• Component list

Component	Part Name	Model Number	Specification	Package	Vendor	Remark
M1	IC	MB39C007WQN	—	QFN-24	FSL	
L1	Inductor	VLF4012AT-2R2M	2.2 μ H, RDC=76 m Ω	SMD	TDK	
L2	Inductor	VLF4012AT-2R2M	2.2 μ H, RDC=76 m Ω	SMD	TDK	
C1	Ceramic capacitor	C2012JB1A475K	4.7 μ F(10 V)	2012	TDK	
C2	Ceramic capacitor	C2012JB1A475K	4.7 μ F(10 V)	2012	TDK	
C3	Ceramic capacitor	C2012JB1A475K	4.7 μ F(10 V)	2012	TDK	
C4	Ceramic capacitor	C2012JB1A475K	4.7 μ F(10 V)	2012	TDK	
C5	Ceramic capacitor	C1608JB1E104K	0.1 μ F(50 V)	1608	TDK	
C6	Ceramic capacitor	C1608JB1H104K	0.1 μ F(50 V)	1608	TDK	
C7	Ceramic capacitor	C1608JB1H104K	0.1 μ F(50 V)	1608	TDK	
R1	Resistor	RK73Z1J	0 Ω , 1 A	1608	KOA	
R1-1	Resistor	RK73Z1J	0 Ω , 1 A	1608	KOA	
R1-2	Resistor	RR0816P-304-D	300 k Ω \pm 0.5%	1608	SSM	
R2	Resistor	RR0816P-753-D	75 k Ω \pm 0.5%	1608	SSM	
R3	Resistor	RK73G1JTDD D 1M Ω	1 M Ω \pm 0.5%	1608	KOA	
R4	Resistor	RK73Z1J	0 Ω , 1 A	1608	KOA	
R4-1	Resistor	RR0816P-133-D	13 k Ω \pm 0.5%	1608	SSM	
R4-2	Resistor	RR0816P-334-D	330 k Ω \pm 0.5%	1608	SSM	
R5	Resistor	RR0816P-304-D	300 k Ω \pm 0.5%	1608	SSM	
R6-1	Resistor	RR0816P-133-D	13 k Ω \pm 0.5%	1608	SSM	
R6-2	Resistor	RR0816P-154-D	150 k Ω \pm 0.5%	1608	SSM	
R7	Resistor	RR0816P-304-D	300 k Ω \pm 0.5%	1608	SSM	
R8	Resistor	RK73G1JTDD D 1M Ω	1 M Ω \pm 0.5%	1608	KOA	
R9	Resistor	RK73G1JTDD D 1M Ω	1 M Ω \pm 0.5%	1608	KOA	
R10	Resistor	RK73G1JTDD D 1M Ω	1 M Ω \pm 0.5%	1608	KOA	
SW1	DIP switch	—	—	—	—	Not mounted
JP1	Jumper	—	—	—	—	Pattern-shorted
JP2	Jumper	—	—	—	—	Pattern-shorted
JP3	Jumper	—	—	—	—	Not mounted
JP6	Jumper	RK73Z1J	0 Ω , 1A	1608	KOA	

Note : These components are recommended based on the operating tests authorized.

FSL : FUJITSU SEMICONDUCTOR LIMITED

TDK : TDK Corporation

KOA : KOA Corporation

SSM : SUSUMU Co., Ltd

■ EV BOARD ORDERING INFORMATION

EV Board Part No.	EV Board Version No.	Remarks
MB39C007EVB-06	MB39C007EVB-06 Rev.2.0	QFN-24

■ PACKAGE DIMENSION

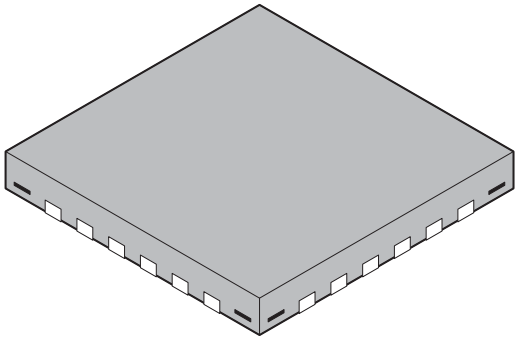
<p>24-pin plastic QFN</p>  <p>(LCC-24P-M10)</p>	Lead pitch	0.50 mm
	Package width × package length	4.00 mm × 4.00 mm
	Sealing method	Plastic mold
	Mounting height	0.80 mm Max
	Weight	0.04 g

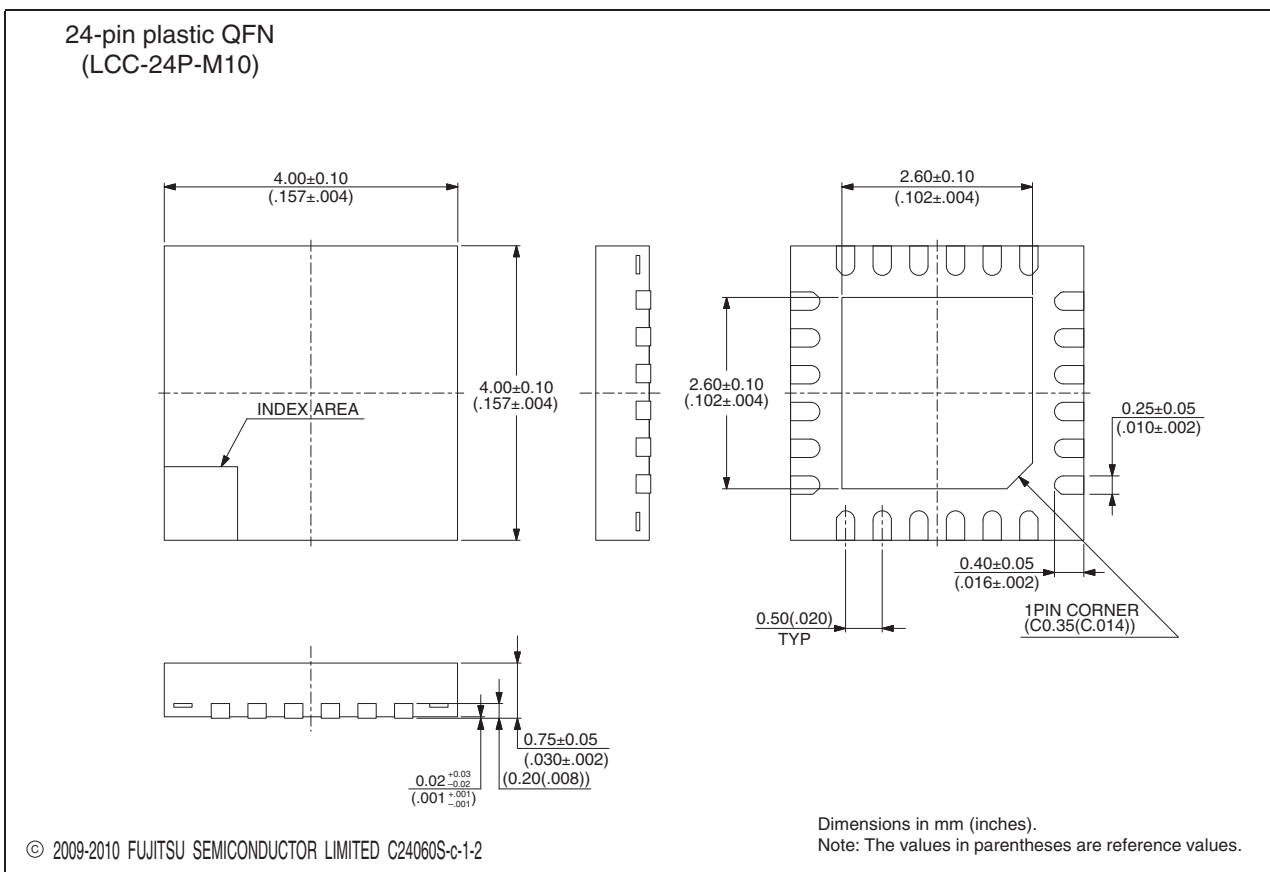

Please check the latest package dimension at the following URL.
<http://edevice.fujitsu.com/package/en-search/>

■ CONTENTS

	page
- DESCRIPTION	1
- FEATURES	1
- APPLICATIONS	1
- PIN ASSIGNMENT	2
- PIN DESCRIPTIONS	3
- I/O PIN EQUIVALENT CIRCUIT DIAGRAM	4
- BLOCK DIAGRAM	5
- FUNCTION OF EACH BLOCK	7
- ABSOLUTE MAXIMUM RATINGS	9
- RECOMMENDED OPERATING CONDITIONS	10
- ELECTRICAL CHARACTERISTICS	11
- TEST CIRCUIT FOR MEASURING TYPICAL OPERATING CHARACTERISTICS	13
- APPLICATION NOTES	14
- EXAMPLE OF STANDARD OPERATION CHARACTERISTICS	22
- APPLICATION CIRCUIT EXAMPLES	35
- USAGE PRECAUTIONS	38
- ORDERING INFORMATION	39
- RoHS COMPLIANCE INFORMATION OF LEAD (Pb) FREE VERSION	40
- MARKING FORMAT (LEAD FREE VERSION)	40
- LABELING SAMPLE (LEAD FREE VERSION)	41
- EVALUATION BOARD SPECIFICATION	42
- EV BOARD ORDERING INFORMATION	48
- PACKAGE DIMENSION	49

MEMO

FUJITSU SEMICONDUCTOR LIMITED

Nomura Fudosan Shin-yokohama Bldg. 10-23, Shin-yokohama 2-Chome,
Kohoku-ku Yokohama Kanagawa 222-0033, Japan

Tel: +81-45-415-5858

<http://jp.fujitsu.com/fsl/en/>

For further information please contact:

North and South America

FUJITSU SEMICONDUCTOR AMERICA, INC.

1250 E. Arques Avenue, M/S 333

Sunnyvale, CA 94085-5401, U.S.A.

Tel: +1-408-737-5600 Fax: +1-408-737-5999

<http://us.fujitsu.com/micro/>

Asia Pacific

FUJITSU SEMICONDUCTOR ASIA PTE. LTD.

151 Lorong Chuan,

#05-08 New Tech Park 556741 Singapore

Tel : +65-6281-0770 Fax : +65-6281-0220

<http://www.fujitsu.com/sg/services/micro/semiconductor/>

Europe

FUJITSU SEMICONDUCTOR EUROPE GmbH

Pittlerstrasse 47, 63225 Langen, Germany

Tel: +49-6103-690-0 Fax: +49-6103-690-122

<http://emea.fujitsu.com/semiconductor/>

FUJITSU SEMICONDUCTOR SHANGHAI CO., LTD.

Rm. 3102, Bund Center, No.222 Yan An Road (E),

Shanghai 200002, China

Tel : +86-21-6146-3688 Fax : +86-21-6335-1605

<http://cn.fujitsu.com/fss/>

Korea

FUJITSU SEMICONDUCTOR KOREA LTD.

206 Kosmo Tower Building, 1002 Daechi-Dong,

Gangnam-Gu, Seoul 135-280, Republic of Korea

Tel: +82-2-3484-7100 Fax: +82-2-3484-7111

<http://kr.fujitsu.com/fmk/>

FUJITSU SEMICONDUCTOR PACIFIC ASIA LTD.

10/F., World Commerce Centre, 11 Canton Road,

Tsimshatsui, Kowloon, Hong Kong

Tel : +852-2377-0226 Fax : +852-2376-3269

<http://cn.fujitsu.com/fsp/>

Specifications are subject to change without notice. For further information please contact each office.

All Rights Reserved.

The contents of this document are subject to change without notice.

Customers are advised to consult with sales representatives before ordering.

The information, such as descriptions of function and application circuit examples, in this document are presented solely for the purpose of reference to show examples of operations and uses of FUJITSU SEMICONDUCTOR device; FUJITSU SEMICONDUCTOR does not warrant proper operation of the device with respect to use based on such information. When you develop equipment incorporating the device based on such information, you must assume any responsibility arising out of such use of the information.

FUJITSU SEMICONDUCTOR assumes no liability for any damages whatsoever arising out of the use of the information.

Any information in this document, including descriptions of function and schematic diagrams, shall not be construed as license of the use or exercise of any intellectual property right, such as patent right or copyright, or any other right of FUJITSU SEMICONDUCTOR or any third party or does FUJITSU SEMICONDUCTOR warrant non-infringement of any third-party's intellectual property right or other right by using such information. FUJITSU SEMICONDUCTOR assumes no liability for any infringement of the intellectual property rights or other rights of third parties which would result from the use of information contained herein.

The products described in this document are designed, developed and manufactured as contemplated for general use, including without limitation, ordinary industrial use, general office use, personal use, and household use, but are not designed, developed and manufactured as contemplated (1) for use accompanying fatal risks or dangers that, unless extremely high safety is secured, could have a serious effect to the public, and could lead directly to death, personal injury, severe physical damage or other loss (i.e., nuclear reaction control in nuclear facility, aircraft flight control, air traffic control, mass transport control, medical life support system, missile launch control in weapon system), or (2) for use requiring extremely high reliability (i.e., submersible repeater and artificial satellite).

Please note that FUJITSU SEMICONDUCTOR will not be liable against you and/or any third party for any claims or damages arising in connection with above-mentioned uses of the products.

Any semiconductor devices have an inherent chance of failure. You must protect against injury, damage or loss from such failures by incorporating safety design measures into your facility and equipment such as redundancy, fire protection, and prevention of over-current levels and other abnormal operating conditions.

Exportation/release of any products described in this document may require necessary procedures in accordance with the regulations of the Foreign Exchange and Foreign Trade Control Law of Japan and/or US export control laws.

The company names and brand names herein are the trademarks or registered trademarks of their respective owners.

Edited: Sales Promotion Department