

PART NAME NEMA 4X DIE CAST ALUMINUM ENCLOSURE

PART No. AN-1303, AN-1303-G, AN-2803 & AN-2803-B

REV. DATE 5-13-09

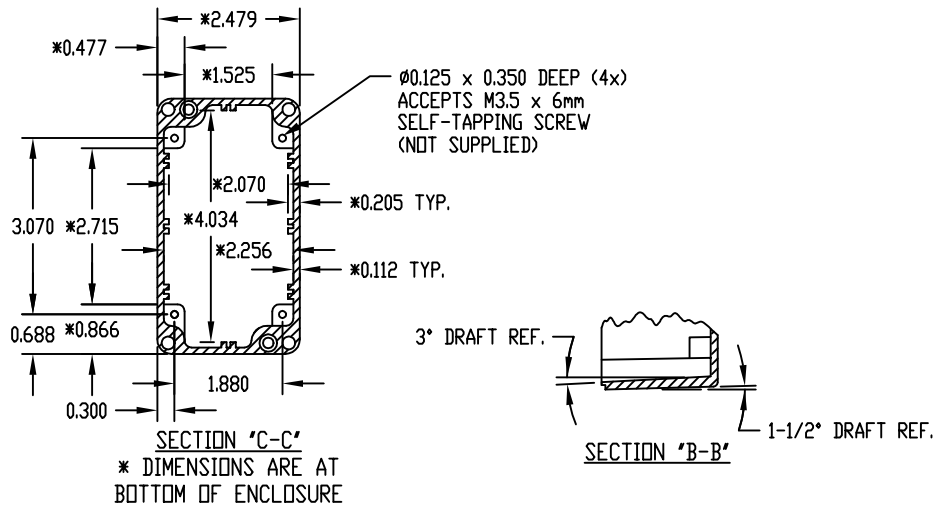

MATERIAL: ALUMINUM ALLOY #ADC-12

FINISH: NATURAL (NO SUFFIX)
GRAY (SUFFIX -G)
SMOOTH BLACK (SUFFIX -B)

- NOTES:
- 1) FOUR (4) M4 x 20mm (0.787") LG. SCREWS SUPPLIED FOR ASSEMBLY OF COVER TO BODY.
 - 2) ALL HOLE DIAMETERS HAVE ±0.005 TOLERANCE ALL OTHER DIMENSIONS HAVE ±0.015 TOLERANCE

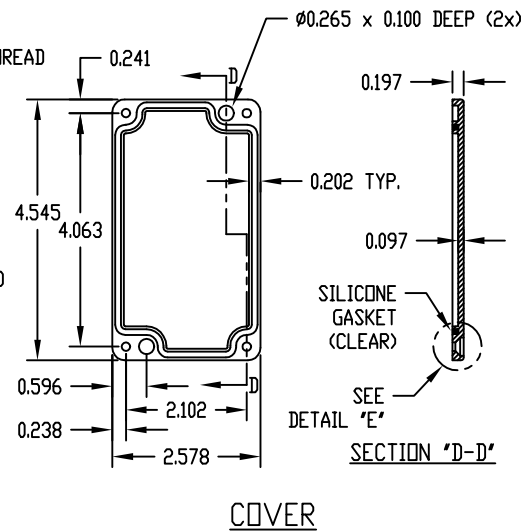
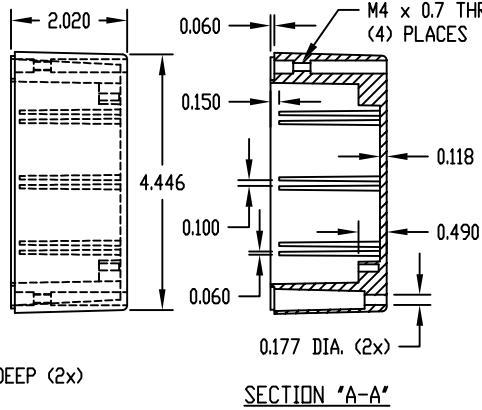
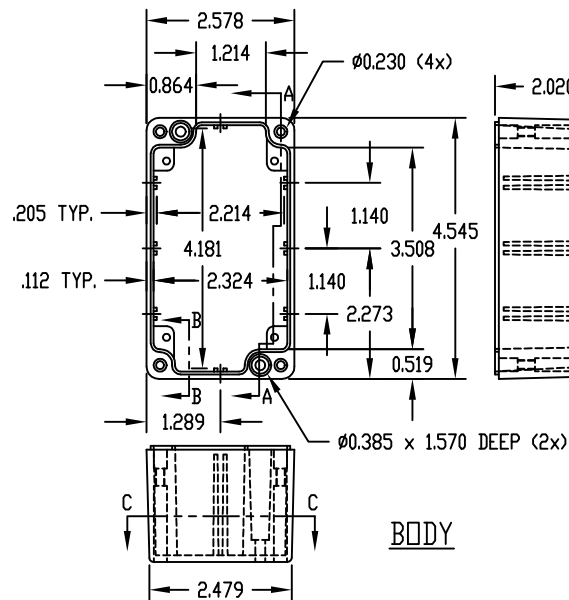
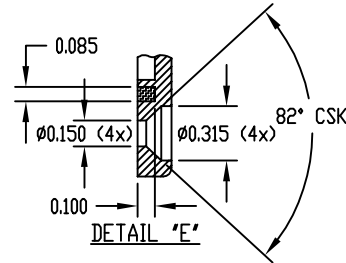

PART NO. AN-2803 & AN-2803-B ARE SUPPLIED WITH A WELDED ON MOUNTING BRACKET ONLY.